



OFFICE OF THE ENVIRONMENT
PRINCIPALITY OF LIECHTENSTEIN

Liechtenstein's Greenhouse Gas Inventory 1990 - 2011

National Inventory Report 2013

Submission of 15 April 2013
under the United Nations Framework Convention on Climate Change
and under the Kyoto Protocol



Published and distributed by:

Office of the Environment (OE)

Postfach 684

FL-9490 Vaduz

Principality of Liechtenstein

www.aus.llv.li

Vaduz, 15 April 2013

Liechtenstein's Greenhouse Gas Inventory 1990-2011

National Inventory Report 2013

Submission of 15 April 2013 under the United Nations Framework Convention on Climate Change and under the Kyoto Protocol

Authors

INFRAS, Zürich/Schweiz

Jürg Heldstab	Executive Summary
Mario Betschart	Introduction, Trends, Energy (Aviation)
Benedikt Notter	Energy (Transport), Agriculture, Recalculations
Martin Herren	Trends, Recalculations
Stefan Kessler	Industrial Processes (Synthetic Gases)

Ernst Basler + Partner, Zollikon/Schweiz

Denise Fussen	Introduction (Key Category Analysis, Uncertainty Evaluation Tier 1), Energy (Energy Industries, Manufacturing, Other Sectors, Fugitive Emissions), Industrial Processes, Solvent and Other Product Use, Waste
Christina Seyler	

Meteotest, Bern

Beat Rihm	LULUCF, KP-LULUCF
-----------	-------------------

Emission modelling

Jürgen Beckbissinger	Acontec, Schaan/Liechtenstein
----------------------	-------------------------------

Office of the Environment, Vaduz/Liechtenstein (www.aus.llv.li)

Helmut Kindle	National Focal Point
Andreas Gstoehl	Head of Inventory Group, Quality Manager (QA/QC)
Patrick Insinna	Project manager, National Inventory Compiler (NIC), Emission data, KP-LULUCF tables, National Registry, National Allocation Plan
Hanspeter Eberle	LULUCF
Sven Braden	Project Manager Assistant, National Allocation Plan, Accounting on Kyoto Units, Emissions Trading, CDM, JI
Heike Summer	Project Manager Assistant

NIR LIE 2013 Master_final.doc

Table of Contents

Table of Contents	5
Glossary	11
EXECUTIVE SUMMARY	13
ES.1 Background Information on Greenhouse Gas Inventories, Climate Change and Supplementary Information Required Under Art. 7.1. KP	13
ES.2 Summary of National Emission and Removal Related Trends, and Emission and Removals from KP-LULUCF Activities	15
ES.3. Overview of Source and Sink Category Estimates and Trends, including KP-LULUCF Activities	16
ES.4. Other Information	19
Acknowledgement	20
PART 1 Annual Inventory Submission	21
1 Introduction	21
1.1 Background Information on Liechtenstein’s Greenhouse Gas Inventory, Climate Change and Supplementary Information of the Kyoto Protocol (KP)	21
1.1.1 Background Information on Climate Change	21
1.1.2 Background Information on Greenhouse Gas Inventory	24
1.1.3 Background Information on Supplementary Information Required under Art. 7.1. KP	25
1.2 Institutional Arrangements for Inventory Preparation, including the Legal and Procedural Arrangements for Inventory Planning, Preparation and Management	25
1.2.1 Overview of Institutional, Legal and Procedural Arrangements for Compiling GHG Inventory and Supplementary Information for KP	25
1.2.2 Overview of Inventory Planning	26
1.2.3 Overview of Inventory Preparation and Management, Including for Supplementary Information for KP	26
1.3 Inventory Preparation	26
1.3.1 GHG Inventory and KP-LULUCF Inventory	26
1.3.2 Data Collection, Processing and Storage, including for KP-LULUCF Inventory	28
1.3.3 QA/QC procedures and extensive review of GHG Inventory and KP-LULUCF Inventory	28
1.4 Methodologies and Data Sources	31
1.4.1 GHG Inventory	31
1.4.2 KP-LULUCF Inventory	33
1.5 Brief Description of Key Categories	34
1.5.1 GHG Inventory	34
1.5.2 KP-LULUCF Inventory	37
1.6 Quality Assurance and Quality Control (QA/QC) Including Verification and Confidentiality Issues	38

1.6.1	QA/QC Procedures	38
1.6.2	Verification Activities	42
1.6.3	Treatment of Confidentiality Issues	43
1.7	Uncertainty Evaluation	43
1.7.1	GHG Inventory	43
1.7.2	KP-LULUCF Inventory	49
1.8	Completeness Assessment.....	49
1.8.1	GHG Inventory	49
1.8.2	KP-LULUCF Inventory	49
2	Trends in Greenhouse Gas Emissions and Removals	51
2.1	Aggregated Greenhouse Gas Emissions 2011	51
2.2	Emission Trends by Gas	53
2.3	Emission Trends by Sources and Sinks	55
2.4	Emission Trends for Indirect Greenhouse Gases and SO ₂	58
2.5	KP-LULUCF Inventory in Aggregate and by Activity, by Gas.....	60
3	Energy.....	61
3.1	Overview.....	61
3.1.1	Greenhouse Gas Emissions.....	61
3.1.2	CO ₂ Emission Factors and Net Calorific Values	64
3.1.3	Energy Statistics (Activity Data)	65
3.2	Source Category 1A – Fuel Combustion Activities	71
3.2.1	Comparison Sectoral Approach - Reference Approach	71
3.2.2	International Bunker Fuels	72
3.2.3	Feedstocks and Non-Energy Use of Fuels	73
3.2.4	CO ₂ Capture from Flue Gases and Subsequent CO ₂ Storage.....	73
3.2.5	Country-Specific Issues.....	74
3.2.6	Source Category 1A.....	74
3.3	Source Category 1B – Fugitive Emissions from Fuels and Oil and Natural Gas	94
4	Industrial Processes	97
4.1	Overview.....	97
4.2	Source Category 2A – Mineral Products	97
4.3	Source Category 2B – Chemical Industry.....	99
4.4	Source Category 2C – Metal Production	99
4.5	Source Category 2D – Other Production.....	99
4.6	Source Category 2E – Production of Halocarbons and SF ₆	100
4.7	Source Category 2F – Consumption of Halocarbons and SF ₆	100
4.8	Source Category 2G – Other.....	108
5	Solvent and Other Product Use.....	109

5.1	Overview.....	109
5.2	Source Category 3A – Paint Application	110
5.3	Source Category 3B – Degreasing and Dry Cleaning	112
5.4	Source Category 3C – Chemical Products, Manufacture and Processing	113
5.5	Source Category 3D – Other.....	115
6	Agriculture.....	119
6.1	Overview.....	119
6.2	Source Category 4A – Enteric Fermentation	121
6.3	Source Category 4B – Manure Management	129
6.4	Source Category 4C – Rice Cultivation	135
6.5	Source Category 4D – Agricultural Soils	136
6.6	Source Category 4E – Burning of savannas.....	144
6.7	Source Category 4F – Field Burning of Agricultural Residues	144
7	Land Use, Land-Use Change and Forestry.....	145
7.1	Overview.....	145
7.2	Methodical Approach and Activity Data	149
7.3	Source Category 5A – Forest Land	161
7.4	Source Category 5B – Cropland	171
7.5	Source Category 5C – Grassland	173
7.6	Source Category 5D – Wetlands.....	178
7.7	Source Category 5E – Settlements	179
7.8	Source Category 5F – Other Land	181
8	Waste	183
8.1	Overview GHG Emissions.....	183
8.2	Source Category 6A – Solid Waste Disposal on Land.....	184
8.3	Source Category 6B – Wastewater Handling	188
8.4	Source Category 6C – Waste Incineration	191
8.5	Source Category 6D – Other.....	193
9	Other	197
10	Recalculations.....	199
10.1	Explanations and Justifications for Recalculations	199
10.2	Implications for Emission Levels 1990 and 2010.....	201
10.3	Implications for Emissions Trends, including Time Series Consistency	202
10.4	Recalculations in Response to the Review Process and Planned Improvements.....	203
Part 2 Supplementary Information Required under Article 7, Paragraph 1		205
11	KP – LULUCF.....	205
11.1	General Information	205
11.2	Land-related Information	211

11.3	Activity-specific Information.....	211
11.4	Article 3.3.....	215
11.5	Article 3.4.....	217
11.6	Other Information	218
11.7	Information Relating to Article 6	218
12	Accounting on Kyoto Units	219
12.1	Background Information	219
12.2	Summary of Information Reported in the SEF Tables	219
12.3	Discrepancies and Notifications	219
12.4	Publicly Accessible Information.....	219
12.6	KP-LULUCF Accounting	222
13	Changes in National System	222
14	Information on changes in national registry	223
15	Minimization of Adverse Impacts in Accordance with Article 3, Paragraph 14 ..	228
16	Other Information	229
	References.....	231
	Annexes	243
	Annex 1: Key Category Analysis.....	243
A1.1	Complete KCA 2011 without LULUCF categories.....	243
A1.2	Complete KCA 2011 including LULUCF categories	250
	Annex 2: Detailed discussion of methodology and data for estimating CO₂ emissions from fossil fuel combustion.....	256
	Annex 3: Other detailed methodological descriptions for individual source or sink categories	257
A3.1	Additional Data for N ₂ O Emission Calculation of Agricultural Soils (4D)	257
A3.2	Further Information on Land-use change calculation	258
	Annex 4: CO₂ Reference Approach and comparison with Sectoral Approach, and relevant information on the national energy balance	259
	Annex 5: Assessment of completeness and (potential) sources and sinks of greenhouse gas emissions and removals excluded.....	259
	Annex 6: Additional information to be considered as part of the NIR submission (where relevant) or other useful reference information.....	259
	Annex 7: Supplementary Information to the Uncertainty Analysis Tier 2	260
A7.1	Monte Carlo simulations for Liechtenstein's GHG inventory.....	260
A7.2	Monte Carlo results for the GHG inventory 2007	260
A7.3	Further assumptions for Monte Carlo simulation (GHG inventory 2007)	267
	Annex 8: Supplementary Information the QA/QC System.....	269
A8.1	Checklists for QC activities	269
A8.2	Checklists for QA activities (internal review)	272

Annex 9: Voluntary Supplementary Information for Article 3 paragraph 3 of the Kyoto Protocol: Kyoto Tables281

Annex 10: Information required under Art. 7 paragraph 2 of the Kyoto Protocol: National Registry and Commitment Period Reserve (CPR).....282

Glossary

ARR	Annual Inventory Review Report (UNFCCC)
AD	Activity Data
ART	Agroscope Reckenholz-Tänikon Research Station
AZV	Abwasserzweckverband der Gemeinden Liechtensteins (Liechtenstein's wastewater administration union)
CH ₄	Methane
CO	Carbon monoxide
CO ₂ , (CO ₂ eq)	Carbon dioxide (equivalent)
CRF	Common reporting format
DOC	Degradable Organic Carbon
EF	Emission Factor
ERT	Expert Review Team
FAL	Swiss Federal Research Station for Agroecology and Agriculture (since 2006: ART)
FCCC	Framework Convention on Climate Change
FOD	First Order Decay Model
FOEN	Swiss Federal Office of the Environment (former name SAEFL)
Gg	Giga gramme (10 ⁹ g = 1'000 tons = 1 kiloton)
GHFL	Genossenschaft für Heizöllagerung im Fürstentum Liechtenstein (Cooperative society for the Storage of Gas Oil in the Principality of Liechtenstein)
GHG	Greenhouse gas
GPG	Good Practice Guidance
GWP	Global Warming Potential
HFC	Hydrofluorocarbons (e.g. HFC-32 difluoromethane)
IDP	Inventory Development Plan
IEF	Implied Emission Factor
IPCC	Intergovernmental Panel on Climate Change
IR	Initial Report (UNFCCC)
KC	Key Category
KP	Kyoto Protocol
LFO	Light fuel oil (Gas oil)
LGV	Liechtensteinische Gasversorgung (Liechtenstein's gas utility)
LKW	Liechtensteinische Kraftwerke (Liechtenstein's electric power company)
LPG	Liquefied Petroleum Gas (Propane/Butane)
LULUCF	Land-Use, Land-Use Change and Forestry

MJ	Mega Joule (10^6 Joule = 1'000'000 Joule)
MSW	Municipal solid waste
MCF	Methan Conversion Factor
NCV	Net Calorific Value
NFR	Nomenclature for reporting (IPCC code of categories)
NIC	National Inventory Compiler
NIR	National Inventory Report
NIS	National Inventory System
NMVOC	Non-methane volatile organic compounds
N ₂ O	Nitrous oxide (laughing gas)
NO _x	Nitrogen oxides
OEA	Office of Economic Affairs
OE, OEP	Office of the Environment (OE) since 2012, former: Office of Environmental Protection (OEP)
OFIVA	Office of Food Inspection and Veterinary Affairs
OS	Office of Statistics
PFC	Perfluorinated carbon compounds (e.g. Tetrafluoromethane)
QA/QC	Quality assurance/quality control: QA includes a system of review procedures conducted by persons not directly involved in the inventory development process. QC is a system of routine technical activities to control the quality of the inventory.
SAEFL	Swiss Agency for the Environment, Forests and Landscape (former name of Federal Office of the Environment FOEN)
SF ₆	Sulphur hexafluoride
SLP	Stabstelle für Landesplanung, Office of Land Use Planning
SO ₂	Sulphur dioxide
TJ	Tera Joule (10^{12} Joule = 1'000'000 Mega Joule)
UNFCCC	United Nations Framework Convention on Climate Change

EXECUTIVE SUMMARY

ES.1 Background Information on Greenhouse Gas Inventories, Climate Change and Supplementary Information Required Under Art. 7.1. KP

ES.1.1 Background Information on Climate Change

According to research programs, significant negative effects of global climate warming in the Alpine region are to be expected. Changes in the permafrost layer and water drainages will play a central role in this regard.

The average temperature in Switzerland, Liechtenstein's neighboring country, has risen by 0.4°–0.6°C per decade since 1970, in both summer and winter. These observations are expected to hold for Liechtenstein, too. This increase is up to three times as high as the worldwide increase and has been observed in the other Alpine countries as well. Between 1990 and 2100 the increase projected for northern Switzerland is +2.7 °C and 4.8 °C depending on the scenario considered. Further, reductions between 18 and 28% in the summer precipitation amount are being predicted compared to reference period 1980-2009, which would represent a substantial shift in the seasonal distribution of precipitation. Glaciers in the Alps have lost 25% of their volume since 1970. Phenological observations show that the biological beginning of spring has been advancing by 1.5–2.5 days per decade.

The following effects can be expected as a consequence of a further rise in temperature: Heat waves with increased mortality will occur more frequently, also tropical diseases will surface in Central Europe and existing diseases will spread to higher elevations. Indirect consequences for health are to be expected from storm, floods, and landslides. The increasing weather instabilities may lead to floods in winter and droughts in summer time and composition of forest vegetation may change too. Global climate warming will therefore affect various economic sectors in Liechtenstein (e.g. Tourism, Agriculture).

ES.1.2 Background Information on Greenhouse Gas Inventories

In 1995, the Principality of Liechtenstein ratified the United Nations Framework Convention on Climate Change (UNFCCC). Furthermore in 2004, Liechtenstein ratified the Kyoto Protocol to the UNFCCC. A National Inventory System (NIS) according to Article 5.1 of the Kyoto Protocol has been implemented.

In 1995, 2001, 2005 and 2010 Liechtenstein submitted its National Communication Reports to the secretariat of the UNFCCC. Also, a first Greenhouse Gas Inventory (without National Inventory Report) was submitted in the Common Reporting Format (CRF) in 2005. In 2006, two submissions took place, the first on 31 May including the national greenhouse gas inventory for 1990 and 2004 as well as the National Inventory Report (NIR). The second submission on 22 December 2006 contained the national greenhouse gas inventory for the whole time period 1990–2004, National Inventory Report and the Initial Report under Article 7, paragraph 4 of the Kyoto Protocol (OEP 2006, 2006a, 2007a). In May 2007 the GHG inventory 1990–2005 was submitted together with the National Inventory Report (OEP 2007). In February 2008, in April 2009, 2010, 2011, and 2012 the further GHG inventories 1990–2006, 1990-2007, 1990-2008, 1990-2009, and 1990-2010 were submitted together with the National Inventory Report (OEP 2008, OEP 2009a, OEP 2010b, OEP 2011a, OEP 2012b). The present report is Liechtenstein's eighth National Inventory Report, NIR 2013, prepared under the UNFCCC and under the Kyoto Protocol. It includes, as a separate document, Liechtenstein's 1990–2011 Inventory in the CRF. Furthermore, the Standard Electronic Format application (SEF) is submitted along with the NIR 2013, providing an annual account of Kyoto units traded in the respective year.

From 11 to 15 June 2007 an individual review (In-Country Review) took place in Vaduz: The submission documents, the Initial Report and the GHG inventory 1990-2004 including CRF tables and National Inventory Report were objects of the review. Following the recommendations of the expert review team, some minor corrections were carried out in the emission modelling leading to recalculations and some methodological changes (revision of the definition of forests). Due to the recalculation, the time series of the national total of emissions did slightly change and therefore, Liechtenstein's assigned amount has been adjusted by -0.407%. After this correction, Liechtenstein's assigned amount is 1055.623 Gg CO₂ equivalents.

In September 2008, 2009, 2010, 2011 and 2012 centralized reviews of Liechtenstein's GHG inventories and NIRs of 2007/2008, 2009, 2010, 2011, and 2012 took place in Bonn, Germany. Again a number of recommendations were addressed to Liechtenstein, which were accounted for in the subsequent submissions (FCCC/ARR 2009, 2010, 2010a, 2011; the ARR 2012 will soon be available).

The Office of the Environment (OE) is in charge of compiling the emission data and bears overall responsibility for Liechtenstein's national greenhouse gas inventory. All inventory data are assembled and prepared for input by an inventory group. It is responsible for ensuring the conformity of the inventory with UNFCCC guidelines. In addition to the OE, the Office of Economic Affairs (OEA) and the Office of Land Use Planning (SLP) participate directly in the compilation of the inventory. Several other administrative and private institutions are involved in inventory preparation.

The emissions are calculated based on the standard methods and procedures of the Revised 1996 Intergovernmental Panel on Climate Change (IPCC) Guidelines for National Greenhouse Gas Inventories (IPCC 1997a, 1997b, 1997c) and IPCC Good Practice Guidances (IPCC 2000, IPCC 2003) as adopted by the UNFCCC. The activity data sources used to compile the national inventory and to estimate greenhouse gas emissions and removals are: The national energy statistics, separate statistics for the consumption of gasoline and diesel oil, agriculture, LULUCF and waste. The data is compiled and set up in line with the FCCC inventory guidelines (FCCC 2003). The data is finally implemented in the CRF Reporter that generates the **CRF tables**.

The **National Inventory Report** follows in its structure the default chapters of the UNFCCC Guidelines on Reporting of Greenhouse Gas Inventories (FCCC 2002) and the "Annotated outline of the National Inventory Report including reporting elements under the Kyoto Protocol" (FCCC 2006).

For the interpretation of the Liechtenstein's emissions and removals it is important to recognise that Liechtenstein is a small central European State in the Alpine region with a population of 36'476 inhabitants (as of 31 December 2011) and with an area of 160 km². Its neighbours are therefore important partners: Liechtenstein and Switzerland form a customs and monetary union governed by a customs treaty. On the basis of this union, Liechtenstein is linked to Swiss foreign trade strategies, with few exceptions, such as trade with the European Economic Community: Liechtenstein – contrary to Switzerland – is a member of the European Economic Area. The Customs Union Treaty with Switzerland impacts greatly on environmental and fiscal strategies. Many Swiss levies and regulations for special goods (for example, environmental standards) are also adapted and applied in Liechtenstein. For the determination of the GHG emissions, Liechtenstein appreciates having been authorised to adopt a number of Swiss methods and Swiss emission factors.

ES.1.3 Background Information on Supplementary Information Required under Article 7.1. KP

According to paragraph 25 of the annex to decision 13/CMP.1, Liechtenstein had to determine for each activity of the LULUCF sector whether removal units (RMUs) shall be issued annually or for the entire commitment period. Liechtenstein has chosen to account

annually for emissions and removals from the LULUCF sector [see Chapter 7 of the Initial Report (OEP 2006a)]. The decision remains fixed for the entire first commitment period.

Liechtenstein has elected to not account for LULUCF activities under Article 3.4 during the first commitment period, as stated in its Initial Report (OEP 2006a, p.22).

For forest, Liechtenstein has chosen the following definition (OEP 2007b):

- minimum area of land: 0.0625 hectares (with a minimum width of 25 m)
- minimum crown cover: 20 per cent
- minimum height of the dominant trees: 3 m (dominant trees must have the potential to reach 3 m at maturity in situ)

ES.2 Summary of National Emission and Removal Related Trends, and Emission and Removals from KP-LULUCF Activities

ES.2.1 GHG Inventory

In 2011, Liechtenstein emitted 222.0 Gg CO₂ equivalent, or 6.1 tonnes CO₂ equivalent per capita (CO₂ only: 5.1 tonnes per capita) to the atmosphere excluding LULUCF.

From 1990 until 2011 the national total emissions excluding LULUCF decreased by 3.6%. If the total includes the emissions from LULUCF, the decrease is 2.7%.

Uncertainties: An uncertainty analysis (Tier 1) is carried out and presented in Chapter 1.7.1.3. It estimates the level uncertainty of total CO₂ equivalent emissions including LULUCF sector in 2011 of 5.28% (level uncertainty) and the trend uncertainty 1990-2011 of 5.19%.

Recalculations: Some emissions have been recalculated due to updates in respective sectors. The results are discussed in Chapter 10. For the base year 1990 there is a slight decrease of 0.137% in the national total emissions excluding LULUCF. If emissions and removals from LULUCF are included, the decrease in the base year 1990 of the national total is 0.706%. The national total emissions of the year 2010 have been recalculated as well. There is a slight increase 0.407% without LULUCF and even a slight decrease of 0.086% with LULUCF activities in 2010.

ES.2.2 KP-LULUCF Activities

Liechtenstein reports the mandatory LULUCF activities Afforestation and Deforestation (Reforestation is not occurring in Liechtenstein) under Article 3, paragraph 3 of the Kyoto Protocol. ES Table 1-1 shows the result for the second KP-LULUCF Inventory year 2011. Afforestation and deforestation resulted in a net emission of 0.21 Gg CO₂ in 2011.

ES Table 1-1: Summary table afforestation and deforestation. Numbers are taken from Table KP(5-I)A.1.1. and KP(5-I)A.2.

Activity	Area	Net CO ₂ emission/removal
	(cumulated 1990-2011) kha	2011 Gg CO ₂
Afforestation	0.03	-0.18
Deforestation	0.02	0.39
Total net CO₂ emission/removal		0.21

ES.3. Overview of Source and Sink Category Estimates and Trends, including KP-LULUCF Activities

ES.3.1 GHG Inventory

ES Figure 1-1 shows the emissions in 2011 by gases. The main GHG is CO₂ with a share of 83.2%. CH₄ and N₂O contribute with 6.9% and 5.9%, synthetic gases with 3.9%.

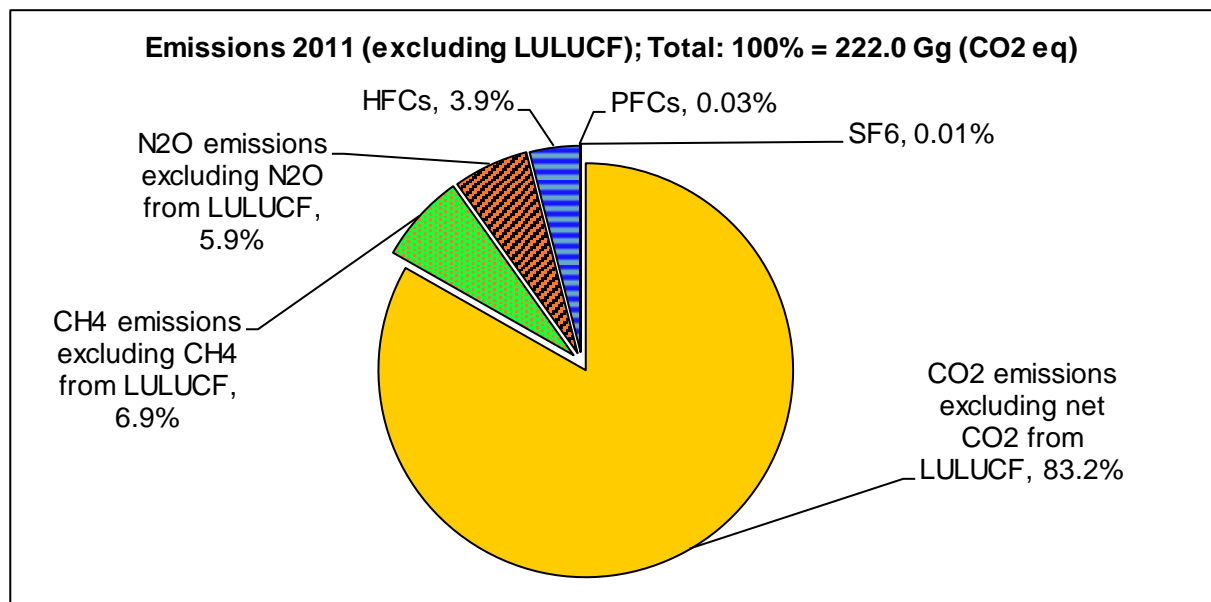

ES Figure 1-1 Liechtenstein's GHG emissions by gas (excluding LULUCF) in 2011.

ES Figure 1-2 shows that the 2011 shares are typical for the period 1990-2011. After increasing emissions between 1990 and 1998, the emissions fluctuate between 1998 and 2006 on a relative constant level. Due to warm winter times and high fuel prices, the consumption decreased in 2007. In 2008 it reached a higher level again and then decreased in 2009, 2010, and subsequent in 2011, indicating a negative emissions trend since 2006.

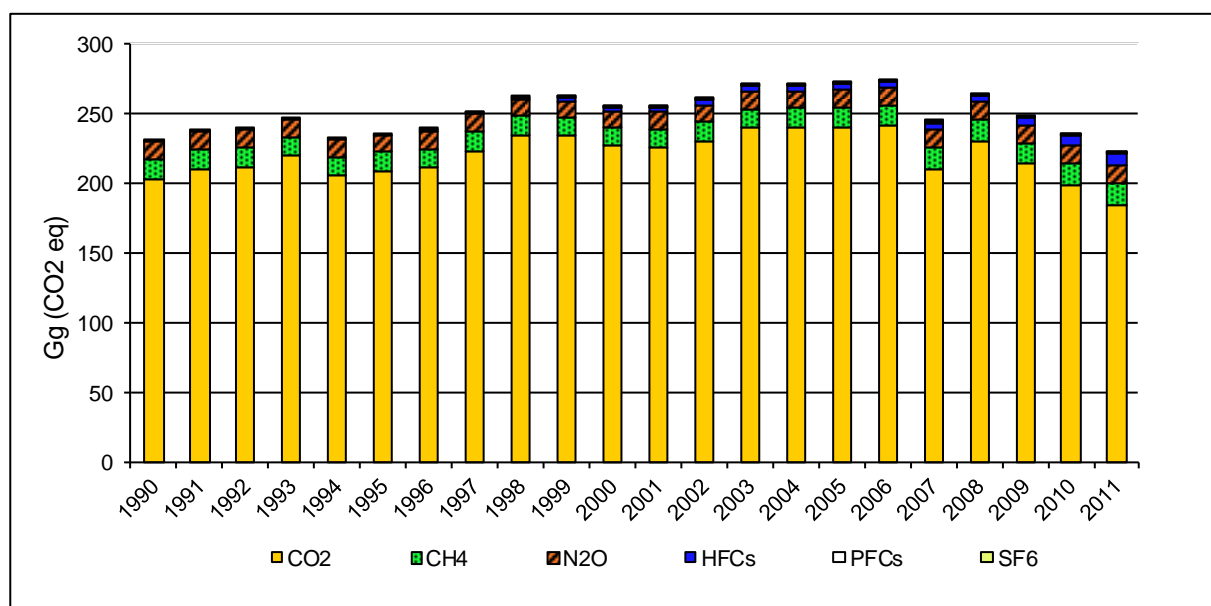

ES Figure 1-2 Trend of Liechtenstein's greenhouse gas emissions by gases 1990–2011. CO₂, CH₄ and N₂O correspond to the respective total emissions excluding LULUCF.

Over the period 1990-2011, the share of CO₂ fluctuated between 83.2% (2011) and 89.7% (1999). The share of CH₄ increased slightly with 6.2% in 1990 and 6.9% in 2011.

Simultaneously, the share of N₂O increased from 5.6% to 5.9% whereas the share of synthetic gases increased from 0.0% (1990) to 3.9% (2011).

ES Table 1-2 Summary of Liechtenstein's GHG emissions in CO₂ equivalent (Gg) by gas, 1990–2011. The last column shows the percentage change in emissions in 2011 as compared to the base year 1990.

Greenhouse Gas Emissions	1990	1991	1992	1993	1994	1995	1996	1997	1998	1999
	CO ₂ equivalent (Gg)									
CO ₂ emissions including net CO ₂ from LULUCF	193.6	201.3	202.2	210.4	196.5	199.8	201.9	214.5	226.1	225.5
CO ₂ emissions excluding net CO ₂ from LULUCF	203.1	210.8	211.7	220.0	206.1	209.4	211.6	223.9	235.2	234.3
CH ₄ emissions including CH ₄ from LULUCF	14.4	14.2	14.0	13.3	13.5	13.4	13.8	13.5	13.5	13.1
CH ₄ emissions excluding CH ₄ from LULUCF	14.4	14.2	14.0	13.3	13.5	13.4	13.8	13.5	13.5	13.1
N ₂ O emissions including N ₂ O from LULUCF	12.9	13.2	13.1	12.7	12.6	12.5	12.5	12.4	12.3	12.1
N ₂ O emissions excluding N ₂ O from LULUCF	12.9	13.2	13.1	12.7	12.6	12.5	12.5	12.4	12.3	12.1
HFCs	0.0	0.0	0.0	0.1	0.1	0.4	0.7	1.0	1.4	1.8
PFCs	NA,NO	NA,NO	NA,NO	NA,NO	NA,NO	NA,NO	NA,NO	NA,NO	0.0	0.0
SF ₆	NA,NO	NA,NO	NA,NO	NA,NO	NA,NO	NA,NO	0.0	0.0	0.0	0.0
Total (including LULUCF)	220.9	228.8	229.2	236.5	222.7	226.1	228.9	241.5	253.2	252.5
Total (excluding LULUCF)	230.3	238.3	238.8	246.1	232.3	235.7	238.6	250.9	262.4	261.3

Greenhouse Gas Emissions	2000	2001	2002	2003	2004	2005	2006	2007	2008	2009
	CO ₂ equivalent (Gg)									
CO ₂ emissions including net CO ₂ from LULUCF	219.0	217.3	222.5	232.1	232.3	232.2	234.0	203.4	222.5	206.9
CO ₂ emissions excluding net CO ₂ from LULUCF	227.6	225.6	230.6	240.0	240.2	239.9	241.6	210.9	229.9	214.2
CH ₄ emissions including CH ₄ from LULUCF	13.0	13.6	13.9	14.0	14.1	14.6	15.2	15.5	15.8	15.5
CH ₄ emissions excluding CH ₄ from LULUCF	13.0	13.6	13.9	14.0	14.1	14.6	15.2	15.5	15.8	15.5
N ₂ O emissions including N ₂ O from LULUCF	12.0	12.3	12.3	12.4	12.4	12.6	12.8	12.9	13.0	12.8
N ₂ O emissions excluding N ₂ O from LULUCF	12.0	12.3	12.3	12.4	12.4	12.6	12.8	12.9	13.0	12.8
HFCs	2.3	3.0	3.3	3.8	4.3	4.4	4.4	4.7	5.1	5.3
PFCs	0.0	0.0	0.0	0.0	0.0	0.0	0.0	0.1	0.1	0.1
SF ₆	0.1	0.2	0.3	0.3	0.3	0.3	0.1	0.1	0.4	0.1
Total (including LULUCF)	246.3	246.4	252.2	262.5	263.5	264.1	266.4	236.7	256.8	240.8
Total (excluding LULUCF)	254.9	254.7	260.3	270.5	271.3	271.8	274.0	244.2	264.2	248.0

Greenhouse Gas Emissions	2010	2011	1990-2011
	CO ₂ equivalent (Gg)		%
CO ₂ emissions including net CO ₂ from LULUCF	192.4	177.8	-8.2
CO ₂ emissions excluding net CO ₂ from LULUCF	199.6	184.8	-9.0
CH ₄ emissions including CH ₄ from LULUCF	15.1	15.4	7.2
CH ₄ emissions excluding CH ₄ from LULUCF	15.1	15.4	7.2
N ₂ O emissions including N ₂ O from LULUCF	12.7	13.0	1.3
N ₂ O emissions excluding N ₂ O from LULUCF	12.7	13.0	1.2
HFCs	6.7	8.7	---
PFCs	0.1	0.1	---
SF ₆	0.0	0.0	---
Total (including LULUCF)	227.0	215.0	-2.7
Total (excluding LULUCF)	234.1	222.0	-3.6

ES Table 1-3 shows the GHG emissions and removals by categories. The energy sector is the largest source of national emissions, contributing to 84.3% of the emissions (excluding LULUCF). A decrease of 8.2% is found for the energy sector for the period 1990–2011. The emissions from industrial processes exclusively consist of synthetic gases, which have increased since 1990, whereas emissions from Solvent and other Product Use have decreased by 50.7%. The emissions from agriculture show a slight decrease from 1990–2000 followed by a slight increase. In 2011 the emissions are 1.8% above the level of 1990. Emissions and removals in the LULUCF sector form a net sink with net removals in the range between -7.0 to -9.7 Gg CO₂ eq from 1990 and 2011. The emissions from the waste sector have increased by 13.16% since 1990, but notably it encompasses only a small amount of

emissions - mainly from composting – because municipal solid waste is exported to a Swiss incineration plant.

ES Table 1-3 Summary of Liechtenstein's GHG emissions by source and sink categories in CO₂ equivalent (Gg), 1990–2011. The column on the last shows the percent change in emissions in 2011 as compared to the base year 1990.

Source and Sink Categories	1990	1991	1992	1993	1994	1995	1996	1997	1998	1999
	CO ₂ equivalent (Gg)									
1 Energy	203.8	211.7	212.8	221.2	207.2	210.6	212.9	225.3	236.7	236.0
1A1 Energy Industries	0.2	0.8	1.9	1.9	1.8	2.0	2.5	2.5	2.9	2.9
1A2 Manufacturing Industries and Construction	35.3	34.2	34.2	36.0	34.2	34.4	34.3	35.9	38.2	37.6
1A3 Transport	76.7	90.0	89.2	87.0	79.6	81.5	82.8	86.4	86.1	91.8
1A4 Other Sectors	88.9	83.4	84.2	93.3	88.8	89.9	90.3	97.4	105.9	99.8
1A5 Other (Offroad)	2.4	2.9	3.0	2.4	2.3	2.2	2.3	2.6	3.0	3.1
1B Fugitive emissions from oil and natural gas	0.3	0.4	0.4	0.5	0.5	0.5	0.6	0.6	0.7	0.7
2 Industrial Processes	0.0	0.0	0.0	0.1	0.1	0.4	0.7	1.0	1.4	1.8
3 Solvent and Other Product Use	2.0	1.9	1.8	1.7	1.7	1.6	1.5	1.4	1.4	1.3
4 Agriculture	23.0	23.1	22.6	21.6	21.7	21.6	21.9	21.5	21.3	20.6
6 Waste	1.6	1.5	1.5	1.5	1.6	1.5	1.6	1.6	1.6	1.6
Total (excluding LULUCF)	230.3	238.3	238.8	246.1	232.3	235.7	238.6	250.9	262.4	261.3
5 Land Use, Land-Use Change and Forestry	-9.5	-9.5	-9.5	-9.6	-9.6	-9.6	-9.7	-9.4	-9.1	-8.9
Total (including LULUCF)	220.9	228.8	229.2	236.5	222.7	226.1	228.9	241.5	253.2	252.5

Source and Sink Categories	2000	2001	2002	2003	2004	2005	2006	2007	2008	2009
	CO ₂ equivalent (Gg)									
1 Energy	229.5	227.4	232.4	242.0	242.2	242.1	243.8	213.2	232.3	216.5
1A1 Energy Industries	2.7	2.9	2.5	2.8	2.9	3.1	2.8	2.5	2.9	2.9
1A2 Manufacturing Industries and Construction	34.3	34.6	35.7	38.3	37.4	36.2	37.4	30.9	33.0	23.8
1A3 Transport	95.8	92.2	87.7	87.3	86.1	85.6	82.6	86.7	91.1	85.0
1A4 Other Sectors	92.8	94.4	103.0	109.3	111.9	112.7	116.2	88.6	100.5	100.2
1A5 Other (Offroad)	3.0	2.6	2.8	3.5	3.1	3.5	3.7	3.4	3.6	3.7
1B Fugitive emissions from oil and natural gas	0.7	0.8	0.8	0.9	0.9	1.0	1.1	1.1	1.1	1.0
2 Industrial Processes	2.4	3.2	3.5	4.0	4.6	4.7	4.5	4.8	5.5	5.5
3 Solvent and Other Product Use	1.2	1.2	1.1	1.1	1.0	1.0	1.0	1.0	1.0	1.0
4 Agriculture	20.1	21.3	21.5	21.6	21.7	22.1	23.0	23.3	23.4	23.2
6 Waste	1.7	1.6	1.7	1.8	1.7	1.9	1.8	1.9	2.0	1.8
Total (excluding LULUCF)	254.9	254.7	260.3	270.5	271.3	271.8	274.0	244.2	264.2	248.0
5 Land Use, Land-Use Change and Forestry	-8.6	-8.3	-8.0	-7.9	-7.8	-7.7	-7.6	-7.5	-7.4	-7.2
Total (including LULUCF)	246.3	246.4	252.2	262.5	263.5	264.1	266.4	236.7	256.8	240.8

Source and Sink Categories	2010	2011	1990-2011
	CO ₂ equivalent (Gg)		%
1 Energy	201.9	187.1	-8.2
1A1 Energy Industries	3.2	3.0	1613.4
1A2 Manufacturing Industries and Construction	22.4	19.4	-45.2
1A3 Transport	80.5	79.5	3.7
1A4 Other Sectors	91.3	80.2	-9.8
1A5 Other (Offroad)	3.5	4.0	65.8
1B Fugitive emissions from oil and natural gas	1.1	1.0	223.1
2 Industrial Processes	6.7	8.8	--
3 Solvent and Other Product Use	1.0	1.0	-50.7
4 Agriculture	22.7	23.4	1.8
6 Waste	1.8	1.8	13.2
Total (excluding LULUCF)	234.1	222.0	-3.6
5 Land Use, Land-Use Change and Forestry	-7.1	-7.0	-25.7
Total (including LULUCF)	227.0	215.0	-2.7

KCA:

In 2011, 16 categories were identified as key categories in level and trend analysis for Liechtenstein, covering 95.7% of total greenhouse gas (GHG) emissions (CO₂ equivalent). There are five major key sources which contribute together 65.1% of the key sources:

- 1A3b Energy, Fuel Combustion, Road Transportation, gasoline: CO₂, level contribution 20.0%.
- 1A3b Energy, Fuel Combustion, Road Transportation, diesel: CO₂, level contribution 14.0%.
- 1A4a Energy, Fuel Combustion, Other Sectors, Commercial/Institutional, liquid fuels: CO₂, level contribution 12.2%.
- 1A4b Energy, Fuel Combustion, Other Sectors, Residential, gaseous fuels: CO₂, level contribution 10.3%.
- 1A4a Energy, Fuel Combustion, Other Sectors, Commercial/Institutional, gaseous fuels: CO₂, level contribution 8.6%.

In the KCA 2011 including LULUCF categories there are in total 137 categories. 22 of them are key categories. Six of the key categories are from the LULUCF sector. The largest category is 5A1 Forest Land remaining Forest Land; the other LULUCF key categories are of minor importance.

ES.3.2 KP-LULUCF Activities

See ES 2.2 for KP-LULUCF overview.

ES.4. Other Information

Liechtenstein is member to the Geneva Convention on Long-range Transboundary Air Pollution (CLRTAP) and submits emission data on indirect Greenhouse Gases. For the precursor substances NO_x, CO and NMVOC as well as for the gas SO₂, data from the UNECE – CLRTAP submission is used. Note that the system boundaries for the transportation sector are not the same as under the UNFCCC Reporting since Liechtenstein uses, in accordance to corresponding guidelines, the territorial approach under the CLRTAP and the sales principle for the UNFCCC Reporting, which restricts the comparability of the two data sets.

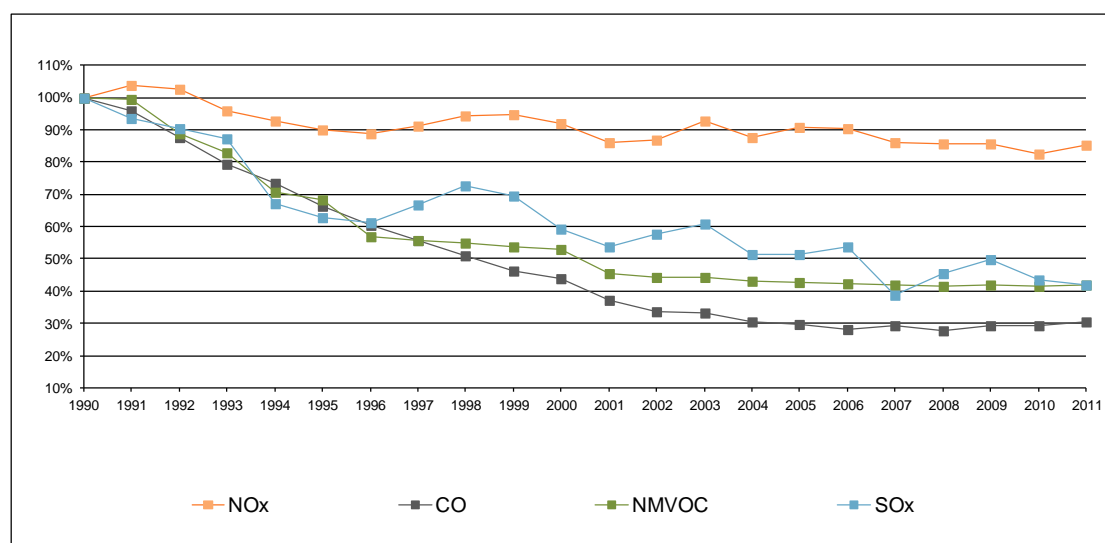

ES Figure 1-3 Trend of emissions of NO_x, CO, NMVOC and SO₂ 1990-2011.

Acknowledgement

Liechtenstein's Office of the Environment (OE) highly appreciates the generous support by the members of the GHG Inventory Core Group at the Swiss Federal Office of Environment (FOEN). The free use of methods and tools developed by the FOEN has been essential during the development of the completely revised Liechtenstein GHG inventory and the NIR.

The OE also gratefully acknowledges the support of the Agroscope Reckenholz-Tänikon Research Station (ART). The use of the worksheet developed by ART greatly facilitated the modelling of agricultural emissions and their uncertainties. Personal and close contacts between the GHG specialists of Switzerland and Liechtenstein developed during this work which laid the basis for a very promising and fruitful cooperation both on a technical and on a political level.

The OE also thanks the data suppliers of Liechtenstein: Office of Economic Affairs, Office of Statistics, Office of Land Use Planning, Liechtensteinische Gasversorgung, Liechtensteinische Kraftwerke, Abwasserzweckverband der Gemeinden Liechtensteins (AZV), Rhein Helikopter AG, the sectoral experts and the NIR authors. Their effort made it possible to finalise the inventory and the NIR in due time.

PART 1

Annual Inventory Submission

1 Introduction

1.1 *Background Information on Liechtenstein's Greenhouse Gas Inventory, Climate Change and Supplementary Information of the Kyoto Protocol (KP)*

1.1.1 Background Information on Climate Change

In recent years, various research programs on the effects of global climate warming in the Alpine region have been conducted. The development so far and projections indicate that noticeable effects are to be expected. Changes to the permafrost line and water drainages will play a central role in this regard (North et al. 2007). Liechtenstein is also affected by these developments.

The expected impacts of climate change have primarily been studied in Switzerland, which is one of the two neighbouring countries of Liechtenstein, and draw to a large extent on the findings of a report prepared by the Swiss Advisory Body on Climate Change (OcCC 2007; OcCC 2008), which documents the present state of knowledge. Also results of a report of the international bodensee conference have been considered with specific findings for Liechtenstein (IBK 2007).

Impacts

The mean annual temperature of Liechtenstein currently is at 10.3°C (1980 – 2009). The mean annual temperature has increased from 8.6 °C in 1980 to 9.9 °C in 2010. According to the Swiss Climate Change Scenarios CH2011 (2011) the future climate of Liechtenstein is expected to change significantly from present and past conditions. The mean temperature will very likely increase by 2.7-4.8 °C until the end of the century, depending on the scenarios. Figure 1-1 illustrates the past and future changes in seasonal temperature (left) and precipitation (right) over northeastern Switzerland. Summer mean precipitation is projected to decrease by 18-28 %, depending on the considered scenario.

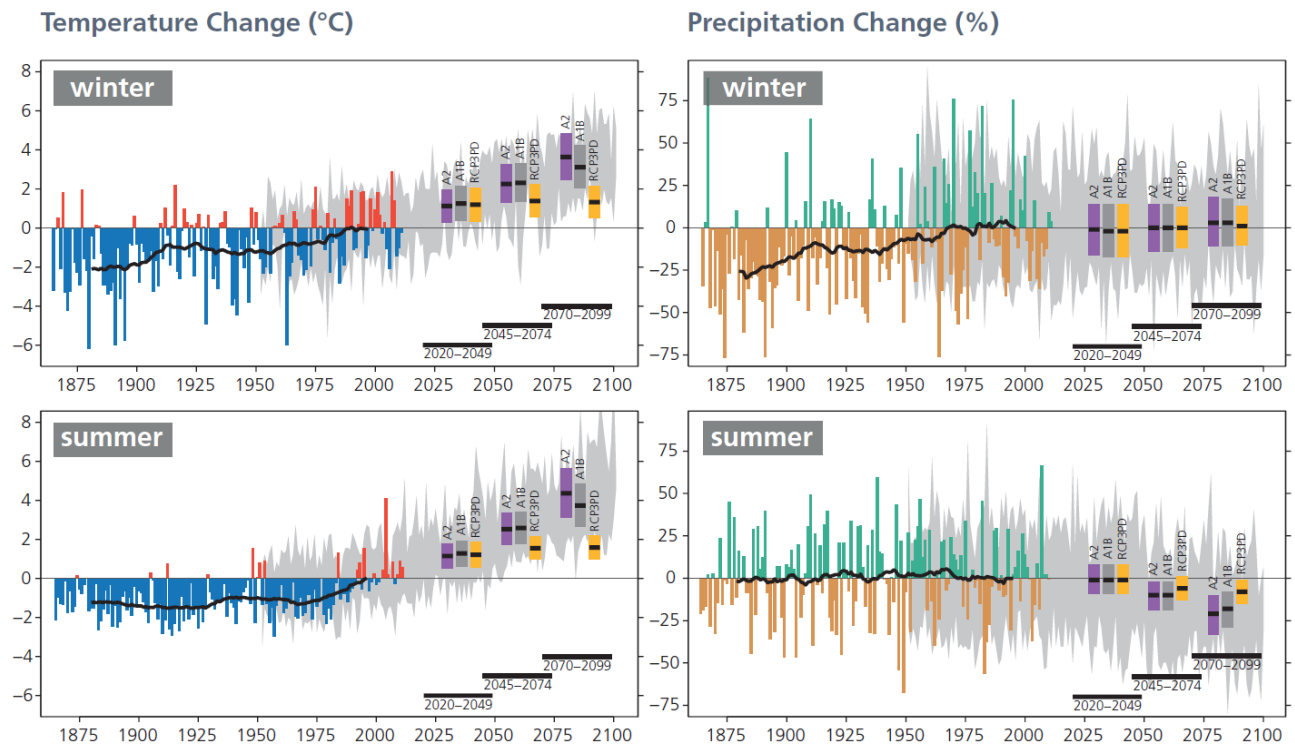

Figure 1-1 Past and future changes in seasonal temperature (°C) and precipitation (%) over northeastern Switzerland. The changes are relative to the reference period 1980-2009. The thin colored bars display the year-to-year differences with respect to the average of observations within the reference period, the heavy black lines are the corresponding smoothed 30-year averages. The grey shading indicates the range of year-to-year differences as projected by climate models for the A1B climate scenario. The thick colored bars show best estimates of the future projections, and associated uncertainty ranges, for selected 30-years time-periods and for three greenhouse gas emission scenarios (from CH2011 2011).

Along with these changes in mean temperature and precipitation, the nature of extreme events is also expected to change towards more frequent, intense and longer-lasting summer warm spells and heat waves (accompanied with drought events). The number of cold winter days and nights is expected to decrease. In addition as shift from solid (snow) to liquid (rain) precipitation is expected, which would increase flood risk primarily in the lowlands (CH2011 2011). The warming trend and changing precipitation patterns are also expected to have significant effects on ecosystems. The Biodiversity Monitoring Switzerland reports that impacts of climate change are being observed even within limited time frames. For instance, typical alpine vascular plants have shifted their distribution in the uphill direction during the past few years and phenological observations show that the biological beginning of spring has been advancing by 1.5 – 2.5 days per decade.

The expected increased intensity of storms and reduced snowfall and snow cover duration are particularly important for alpine areas, tourism and forestry due to more frequent floods, landslides and debris flows and an increase of threats by avalanches.

Vulnerability assessments

It is difficult to transfer the consequences of global climate warming calculated on the basis of models to the spatial scale of Liechtenstein (some 10 km). The available climate models are not yet able to predict detailed regional consequences. Overall, the following general effects can be expected as a consequence of further increasing CO₂ concentrations and the associated rise in temperature.

Health: The increase in intensity of heat waves in combination with high tropospheric ozone concentrations represents the greatest risk that climate change poses to people's health. Another important health risk of climate change is the occurrence of vector-borne diseases.

There is still predominant uncertainty about what future developments will be considering further health issues.

Ecosystems: Warming changes the composition of forest and grasslands vegetations. Deciduous trees may become more important than today. Additional weather instabilities (e.g., storms, avalanches, and debris flows) may have a further negative effect on forest and the vegetation in general. The increasing number of non-native species is a further unknown risk in terms of the entire forest and grassland composition. The same risks apply for the fauna.

Water cycles and soil: The increasing weather instabilities may lead to floods in winter and droughts in summer time. A great danger in this regard exists in the narrow Alpine valleys (mountain streams), where various protective measures (e.g., rock fall barriers and water course corrections) are necessary. A further danger is posed by the Rhine: Although regulated, the river may endanger the intensively used valley floor in the event of a flood.

Tourism: Within the next decades Liechtenstein's tourism sector will have to deal with great challenges caused by climate change related developments in Liechtenstein's ecosystems. Especially the winter tourism sector will be hit by higher temperature as the rise of the freezing level will lead to higher snow lines.

Other economic sectors: Global climate warming will affect further economic sectors in Liechtenstein. Because of the processes described above, agriculture and forestry will be affected directly. A rise in temperature will have a negative effect on the productivity of grain cultivation in the long term. The expected increase in elevation of the snow boundaries and increasing weather instability also have an effect on the important recreation area of Malbun and Steg. The international engagement of the insurance sector will likely suffer the most severe negative consequences from an increase in the probability of losses.

Adaptation/ Mitigation

The projected consequences of an ongoing climate change require the immediate implementation of the so called Two-Pillar-Strategy – Mitigation (Pillar1) and Adaptation (Pillar 2).

Mitigation: The necessary reduction of greenhouse gases can only be achieved if concrete measures are implemented in due time. Liechtenstein has launched a set of measures to address the problem of growing greenhouse gas emissions such as the most recent Energy Strategy 2020 (OEA, 2012), Emissions Trading Act (OEP, 2008b), Energy Efficiency Act (OEA, 2008), CO₂-Act (OEP, 2008c), Environmental Protection Act (OEP, 2008d), National Transport Policies, National Climate Protection Strategy (OEP, 2007d) and Action Plan Air (OEP, 2007e). Liechtenstein's climate policy goal is – in the midterm – to fulfill the obligations originating from the Kyoto Protocol. The mitigation measures however will be further developed, especially with respect to sectors that have not yet been totally included into strict climate change regulation (e.g. traffic and transportation).

Adaptation: It is already obvious that certain climate change related consequences will become irreversible. Pillar 2 deals with the question of how these future threats could be addressed and how potential future damages can be limited or even avoided.

Natural hazard: Liechtenstein has established so called "Geological Risk Maps" with a special focus on residential areas. These maps provide regional information on the specific risks regarding avalanches, rock- and landslides and flooding.

Agriculture: Identified adaptation measures are an increased use of appropriate corn provenances, that have already anticipated future conditions of the changing environment. However, the use of genetically modified crops is not foreseen. The irrigation of agricultural fields will increasingly be used thereby causing conflicts with other public interests, especially during longer draught periods.

Forestry: The increase of draught periods with consequential damages caused by insects, pathogens (viruses, bacteria, fungus,) fire or storms will lead to a decrease of the forest protection abilities in Liechtenstein. Adaptation measures that address the problems of these projected situations and which are already executed are the conversion of spruce and fir stocks into mixed deciduous and coniferous forests.

Tourism: Further efforts have to be stepped up within the next years. The production of artificial snow, as currently practiced, is not considered to be a sustainable solution. Nevertheless, various municipalities and institutions have introduced new offerings for winter and summer tourism, in order to counter potential revenue losses. The focus is on strategies to promote "gentle tourism".

1.1.2 Background Information on Greenhouse Gas Inventory

In 1995, the Principality of Liechtenstein ratified the United Nations Framework Convention on Climate Change (UNFCCC). Furthermore in 2004, Liechtenstein ratified the Kyoto Protocol to the UNFCCC. A National Inventory System (NIS) according to Article 5.1 of the Kyoto Protocol has been implemented.

In 1995, 2001, 2005 and 2010, Liechtenstein submitted its National Communication Reports to the secretariat of the UNFCCC. Greenhouse Gas Inventories and National Inventory Reports were submitted in the following years:

- 2005: The first Greenhouse Gas Inventory of Liechtenstein was submitted in the Common Reporting Format (CRF) without National Inventory Report.
- 2006: The first submission took place on 31 May including the national greenhouse gas inventory for 1990 and 2004 as well as the National Inventory Report. A re-submission on 22 December 2006 contained the national greenhouse gas inventory for the whole time period 1990–2004, the National Inventory Report 2006 (OEP 2006) and the Initial Report under Article 7, paragraph 4 of the Kyoto Protocol including a Corrigendum (OEP 2006a, 2007b).
- 2007: Submission of the Greenhouse Gas Inventory 1990–2005 together with the National Inventory Report 2007 on 10 May 2007 (OEP 2007).
- 2008: Submission of the Greenhouse Gas Inventory 1990–2006 together with the National Inventory Report 2008 prepared under the UNFCCC and under the Kyoto Protocol on 29 February 2008 (OEP 2008).
- 2009: Submission of the Greenhouse Gas Inventory 1990–2007 together with the National Inventory Report 2009 prepared under the UNFCCC and under the Kyoto Protocol on 29 February 2009 (OEP 2009a). Furthermore, the Standard Electronic Format application (SEF) was submitted.
- 2010: Submission of the Greenhouse Gas Inventory 1990–2008 together with the National Inventory Report 2010 prepared under the UNFCCC and under the Kyoto Protocol on 11 March 2010 (OEP 2010b). Additionally, the Standard Electronic Format application (SEF) was submitted. Submission 2010 incorporated the new guidelines: Annotated outline of the National Inventory Report including reporting elements under the Kyoto Protocol (IPPC 2009).
- 2011: Submission of the Greenhouse Gas Inventory 1990–2009 together with the National Inventory Report 2011 prepared under the UNFCCC and under the Kyoto Protocol on 11 March 2011 (OEP 2011a). Additionally, the Standard Electronic Format application (SEF) was submitted.
- 2012: Submission of the Greenhouse Gas Inventory 1990–2010 together with the National Inventory Report 2012 prepared under the UNFCCC and under the Kyoto Protocol on 11 March 2012 (OEP 2012b). Additionally, the Standard Electronic Format application (SEF) was submitted.

- The present report is Liechtenstein's 8th National Inventory Report, NIR 2013, prepared under the UNFCCC and under the Kyoto Protocol. The present report includes, as separate files, Liechtenstein's 1990–2011 Inventory in the CRF Reporter format and the updated Standard Electronic Format application (SEF).

From 11 to 15 June 2007 an individual review (In-Country Review) took place in Vaduz: The submission documents, the Initial Report and the GHG inventory 1990-2004 including CRF tables and National Inventory Report were objects of the review. Following the recommendations of the expert review team, some minor corrections were carried out in the emission modelling, leading to recalculations and some methodological changes (revision of the definition of forests). The consequences are documented in the reports of the review of the initial report of Liechtenstein (FCCC/IRR 2007) and of the individual review of the greenhouse gas inventory of Liechtenstein submitted in 2006 (FCCC/ARR 2007). Due to the recalculation, the time series of the national total of emissions slightly changed and therefore, Liechtenstein's assigned amount has been adjusted by -0.407%. The modifications are documented in a Response by Party and a Corrigendum to the Initial Report (OEP 2007a, 2007b). In September 2008 a centralized review of Liechtenstein's GHG inventories and NIRs of 2007 and 2008 took place in Bonn, Germany with results documented in FCCC/ARR 2009. Further centralized reviews took place in September 2009 (inventory and NIR of 2009, FCCC/ARR 2010), in September 2010 (inventory and NIR 2010, FCCC/ARR 2010a) and in September 2011 (inventory 1990–2009 and NIR 2011, FCCC/ARR 2011).

1.1.3 Background Information on Supplementary Information Required under Art. 7.1. KP

According to paragraph 25 of the annex to decision 13/CMP.1, Liechtenstein had to determine for each activity of the LULUCF sector whether removal units (RMUs) shall be issued annually or for the entire commitment period. Liechtenstein has chosen to account annually for emissions and removals from the LULUCF sector (see Chapter 7 of the Initial Report, OEP 2006a). The decision remains fixed for the entire first commitment period.

Liechtenstein has elected to not account for LULUCF activities under Article 3.4 during the first commitment period, as stated in its Initial Report (OEP 2006a, p.22).

1.2 Institutional Arrangements for Inventory Preparation, including the Legal and Procedural Arrangements for Inventory Planning, Preparation and Management

1.2.1 Overview of Institutional, Legal and Procedural Arrangements for Compiling GHG Inventory and Supplementary Information for KP

The Office of Environment (OE) is in charge of compiling the emission data and bears overall responsibility for Liechtenstein's national greenhouse gas inventory. In addition to the OE, the Office of Economic Affairs (OEA) and the Office of Land Use Planning (SLP) participate directly in the compilation of the inventory. Several other administrative and private institutions are involved in inventory preparation.

Liechtenstein is a small central European State in the Alpine region with a population of 36'476 inhabitants (OS 2011e) and with an area of 160 km². Liechtenstein and its neighbouring country Switzerland form a customs and monetary union governed by a customs treaty (Government, 1980). On the basis of this union, Liechtenstein is linked to Swiss foreign trade strategies, with few exceptions, such as trade with the European Economic Community: Liechtenstein – contrary to Switzerland – is a member of the European Economic Area. The Customs Union Treaty with Switzerland impacts greatly on environmental and fiscal strategies. Many Swiss levies and regulations for special goods, for

example, environmental standards for motor vehicles and quality standards for fuels are also adapted and applied in Liechtenstein. For the determination of the GHG emissions, Liechtenstein appreciates having been authorised to adopt a number of Swiss methods and Swiss emission factors.

As part of a comprehensive project, the Government mandated its Office of Environmental Protection in 2005 to design and establish the NIS in order to ensure full compliance with the reporting requirements of the UNFCCC and its Kyoto Protocol. With regard to the provisions of Art. 5.1 of the Kyoto Protocol, the project encompasses the following elements:

- Collaboration and cooperation of the different offices involved in data collection,
- Upgrading and updating of central GHG emissions data base,
- Setting up a simplified QA/QC system,
- Official consideration and approval of the data.

1.2.2 Overview of Inventory Planning

The planning of the inventory is described in Chapter 1.3.

1.2.3 Overview of Inventory Preparation and Management, Including for Supplementary Information for KP

The Inventory preparation and management is described in Chapter 1.3.

1.3 Inventory Preparation

1.3.1 GHG Inventory and KP-LULUCF Inventory

Figure 1-1 gives a schematic overview of the institutional setting of the process of inventory preparation within the NIS.

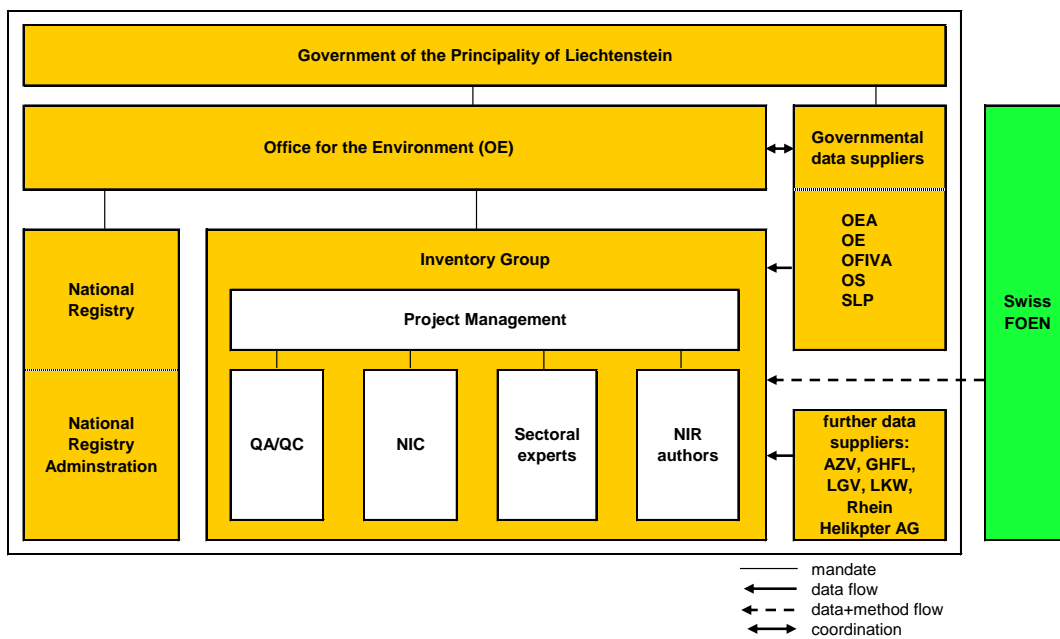

Figure 1-1 National Inventory System: Institutional setting and data suppliers.

The Government of the Principality of Liechtenstein bears the overall responsibility for the NIS. By Liechtenstein's Emission Trading Act (Emissionshandelsgesetz), the Office of the Environment (OE) is in charge of establishing emission inventories and is therefore also responsible for all aspects concerning the establishing of the National Inventory System (NIS) under the Kyoto Protocol. The responsibility of the OE for establishing the NIS is also described in the report of the Government to the parliament for ratifying the Kyoto Protocol. The Government mandated the realisation of the NIS to its Office of the Environment (OE). Please note that the Office of the Environment is reorganized since 2013. The Office of Agriculture (OA), the Office of Forest, Nature and Land Management (OFNLM) and the Office of Environmental Protection (OEP) have been merged to the Office of the Environment (OE).

The Office of the Environment (OE) plays a major role in the National Inventory System and is acting as the National Registry Administrator. Its representative, the head of the OE, is the registered National Focal Point. He also coordinates in cooperation with the responsible head of the unit the data flow from the governmental data suppliers to the Inventory Group.

The Inventory group consists of the project manager, the person responsible for the QA/QC activities, the National Inventory Compiler (NIC) who is represented by the project manager and his assistant. Furthermore several external experts belong to the Inventory Group: Sectoral specialists for modelling the greenhouse gas emissions and removals and the NIR authors.

Among the governmental data suppliers there are

- Office of Economic Affairs (OEA)
- Office of Statistics (OS)
- Office of Land Use Planning (SLP)
- Office of the Environment (OE)

Further data suppliers are

- Liechtenstein's Gas Utility / Liechtensteinische Gasversorgung (LGV)
- Electric power company / Liechtensteinische Kraftwerke (LKW)
- Abwasserzweckverband (AZV)
- Heliport Balzers (Rhein Helikopter AG and ROTEX HELICOPTER AG)

In former years, the cooperative society for the storage of gas oil in the Principality of Liechtenstein (Genossenschaft für Heizöl-Lagerhaltung im Fürstentum Liechtenstein, GHFL) delivered data about the annual storage of fuels. However, the cooperative society was closed in 2008.

Cooperation with the Swiss Federal Office of the Environment (FOEN)

The Swiss Federal Office of the Environment (FOEN) is the agency that has the lead within the Swiss federal administration regarding climate policy and its implementation. The FOEN and Liechtenstein's OE cooperate in the inventory preparation.

- Due to the Customs Union Treaty of the two states, the import statistics in the Swiss overall energy statistics (SFOE 2011) also includes the fossil fuel consumption of the Principality of Liechtenstein except for gas consumption of Liechtenstein which is excluded from SFOE (2011). FOEN therefore corrects its fuel consumption data by subtracting Liechtenstein's liquid fuel consumption from the data provided in the Swiss overall energy statistics. To that aim, OE calculates its energy consumption and provides FOEN with the data.

- FOEN, on the other hand, makes a number of methods and emission factors available to OE, mainly transportation, agriculture, LULUCF, synthetic gases, solvents. Liechtenstein has benefited to a large extent from the methodological support by the inventory core group within the FOEN and its readiness to share very openly data and spreadsheet-tools. Its kind support is herewith highly appreciated.

1.3.2 Data Collection, Processing and Storage, including for KP-LULUCF Inventory

Figure 1-2 illustrates the simplified data flow leading to the CRF tables required for reporting under the UNFCCC and under the Kyoto Protocol. For roles and responsibilities of the contributors see Figure 1-1.

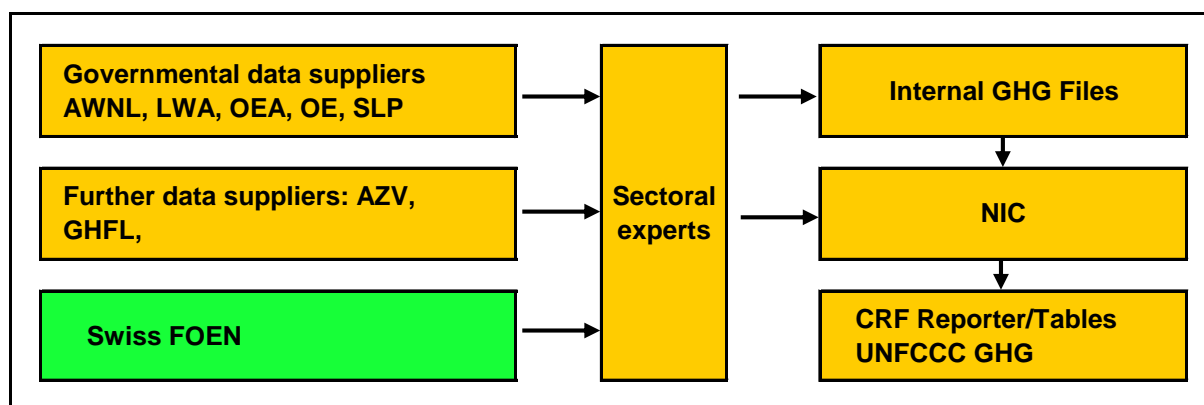

Figure 1-2 Data suppliers and data collection for setting up the UNFCCC GHG Inventory (see Glossary for abbreviations).

1.3.3 QA/QC procedures and extensive review of GHG Inventory and KP-LULUCF Inventory

For QA/QC procedures including internal reviews see Chapter 1.6.

From 11 to 15 June 2007 an individual review (In-Country Review) took place in Vaduz: The submission documents, the Initial Report and the GHG inventory 1990-2004 including CRF tables and National Inventory Report were objects of the review. Following the recommendations of the expert review team, some minor corrections were carried out in the emission modelling leading to recalculations and some methodological changes (revision of the definition of forests). Due to the recalculation, the time series of the national total of emissions slightly changed and therefore, Liechtenstein's assigned amount has been adjusted by -0.407%. After this correction, Liechtenstein's assigned amount has been fixed to 1055.623 Gg CO₂ equivalents.

In September 2008, 2009, 2010, 2011, and 2012 centralized reviews of Liechtenstein's GHG inventories and NIRs of 2007/2008, 2009, 2010, 2011, and 2012 took place in Bonn, Germany. A number of recommendations, addressed to Liechtenstein, are relevant for the current submission:

- Three specific potential problems identified by the ERT were documented in a "Saturday Paper" (FCCC/ARR 2012). The first potential problem is found in the energy sector (1A1a, other fuels) in terms of an underestimation of CO₂, CH₄, and N₂O emissions. The second potential problem concerns fugitive emissions from natural gas transmission and natural gas distribution (1B2biii and 1B2biv) where CH₄ emissions are probably underestimated. The third potential problem affects the afforestation and reforestation. The net removals were considered too high. For further details please refer to respective chapters.

- The “Report of the individual review of the annual submission of Liechtenstein submitted in 2011” (FCCC/ARR/2011/LIE) contains the findings of the ERT including further potential problems beyond the ones mentioned in the “Saturday Paper”.
- The “Report of the individual review of the annual submission of Liechtenstein submitted in 2012” containing the findings of the ERT including further potential problems is still under preparation.

The following tables depicts the recommendations from the ERT which are incorporated into the current report. The recommendations of the reviews (FCCC/ARR 2011 and SIAR (2011)) that could not be implemented yet, are integrated in the Inventory development plan (IDP, see Annex 8.3).

Cross-cutting Issues/Miscellaneous

No	Planned improvement	Responsibility	Status	Reference
	no planned improvement			

Sector Energy

No	Planned improvement	Responsibility	Status	Reference
6	The ERT strongly recommends that Liechtenstein estimate CH ₄ fugitive emissions for public electricity, heat production and commercial/institutional and residential categories.	JB/DEF	Finished in Submission 2013	2011_41
7	The ERT strongly recommends that Liechtenstein justify in its next NIR that the fugitive emissions of natural gas transmission do not occur or, if they are included elsewhere, that the Party use the correct notation key (1E). If these emissions are not estimated, the ERT strongly recommends that Liechtenstein estimate these emissions in its next annual submission.	JB/DEF	Finished in Submission 2013	2011_42
8	The ERT strongly recommends more detailed explanations about the gas oil shares of Liechtenstein.	DEF	Finished in Submission 2013	Answers ERT questions sept. 2012
9	Related to the NIR page 75, Table 3-19 Activity for natural gas and biomass consumption in 1A1 public electricity/heat production, can Liechtenstein explain the rapid increase of natural gas consumption between 1990, 1991, and 1992?	DEF	Finished in Submission 2013	Answers ERT questions sept. 2012
10	Could Liechtenstein explain why they don't use the default oxidation factor for CO ₂ in the energy chapter?	DEF	Finished in Submission 2013	Answers ERT questions sept. 2012
11	Can Liechtenstein provide more explanation on the activity data for fuel consumption in 1A2F Manufacturing industries and construction between 1990 and 2010?	DEF	Finished in Submission 2013	Answers ERT questions sept. 2012
12	Can Liechtenstein provide more explanation to confirm that the coal properties between the Liechtenstein and Switzerland are similar?	DEF	Finished in Submission 2013	Answers ERT questions sept. 2012
13	The ERT noted that Liechtenstein did not include the use of lubricants and bitumen in the inventory. What is the schedule for Liechtenstein to provide estimates on the consumption of both lubricants and bitumen in its inventory?	DEF	progress	Answers ERT questions sept. 2012
14	The ERT considers that the waste incineration plant is situated in Switzerland and therefore the district heating is provided from Switzerland. It is recommended to include a description of this in the next annual submission.	DEF	Finished in Submission 2013	Answers ERT questions sept. 2012

Sectors Industrial processes and solvent and other product use

No	Planned improvement	Responsibility	Status	Reference
15	Provide additional information on differences between the IPCC methodologies and CS methodology used for estimating emissions from 2F1 Refrigeration and Air Conditioning Equipment.	SK	Finished in Submission 2013	2011_43
16	Report on the reasons why HFC emissions in the period 2004 - 2006 changed the previous trend.	SK	Finished in Submission 2013	2011_46
17	Additional information on how Switzerland estimates PFC emissions.	SK	Finished in Submission 2013	2011_47
18	Prived detailed explanation on declining trend of SF6 emissions from the Sub category 2F8 Electrical Equipment from 2008 - 2010.	SK	Finished in Submission 2013	2011_03

Sector Agriculture

No	Planned improvement	Responsibility	Status	Reference
	no planned improvement			

Sector LULUCF

No	Planned improvement	Responsibility	Status	Reference
25	The ERT strongly reiterates the recommendation that Liechtenstein use the 20-year default IPCC value for reporting land-use conversion or provide sufficient justification for the use of a 12-year conversion in its next annual submission.	BR/JB	Finished in Submission 2013	2011_65
26	The ERT recommends that Liechtenstein estimates the emissions from biomass burning or, if it is not applicable for some years, explain why and use the correct notation key (NO) for biomass burning in its next annual submission.	BR/PI	Finished in Submission 2013	2011_66
27	Liechtenstein has reported the area of organic soils as "NE" for all years of the inventory time series. Further, the carbon stock changes from organic soils are reported as included elsewhere" (IE) under mineral soils. The ERT recommends that Liechtenstein address this issue in its next annual	BR/JB	Finished in Submission 2013	2011_68
28	The ERT recommends that Liechtenstein improve completeness of its reporting of the key category carbon stock changes from organic soils by replacing the notation keys by the appropriate values in its next annual submission.	BR/JB	Finished in Submission 2013	2011_70
29	The ERT encourages Liechtenstein to address that carbon stock changes from organic soils are reported as "IE" in its next annual submission or to provide background information and additional explanations.	BR/JB	Finished in Submission 2013	2011_74

Sector KP-LULUCF

No	Planned improvement	Responsibility	Status	Reference
32	The ERT strongly recommends that Liechtenstein complete the reporting of the biomass burning emissions.	PI/BR	Finished in Submission 2013	2011_86
34	The ERT recommends that Liechtenstein include additional information on below-ground biomass emissions.	BR/PI	Finished in Submission 2013	2011_89
37	The ERT strongly recommends that Liechtenstein, in its next annual submission, provide either separate estimates for above-ground and below-ground biomass or comprehensive additional information regarding the approach used and provide estimates for the carbon stock changes for organic soils.		Finished in Submission 2013	2011_92

Sector Waste

No	Planned improvement	Responsibility	Status	Reference
38	In previous submissions, the emission factor of fossil CO ₂ by waste incineration has been calculated by multiplying the corresponding Swiss EF by the factor 0.4. It will be verified whether this is plausible or should be corrected elsewhere. Furthermore it will be checked whether it is justified to use a different emission factor for N ₂ O than in the Swiss NIR.	JB	Finished in Submission 2013	2008_80

1.4 Methodologies and Data Sources

1.4.1 GHG Inventory

1.4.1.1 General Description

The emissions are calculated based on the standard methods and procedures of the Revised 1996 Intergovernmental Panel on Climate Change (IPCC), Guidelines for National Greenhouse Gas Inventories (IPCC 1997a, 1997b, 1997c) and IPCC Good Practice Guidances (IPCC 2000, IPCC 2003) as adopted by the UNFCCC.

The emissions are modelled by using country specific activity data. Country specific emissions factors are applied if available. A number of default emission factors from IPCC are used. For a majority of emission sources, however, emission factors are adopted from the Swiss GHG inventory after checking their applicability. In those cases, the emission factors are reported as country specific. It is noteworthy that there is a very close relationship between Liechtenstein and Switzerland based on the Customs Union Treaty between the two countries (see Section 1.2.1). The Customs Union Treaty with Switzerland has a significant impact on environmental and fiscal strategies. Many Swiss environmental provisions and climate-protection regulations are also applicable in Liechtenstein or are implemented into Liechtenstein law on the basis of specific international treaty rules. **Therefore, a number of emission factors are adopted from Switzerland assuming that the Swiss emission factors actually represent the emission standards more accurately than default emission factors.** This assumption especially holds for

- the sector Energy due to the same fuel quality standards and regulations standards for exhaust gases of combustion and motor vehicles,
- the emission of synthetic gases due to similar consumer's product and attitude,
- the sector Agriculture due to similar stock farming and cultivation of land,
- the sector LULUCF due to – again – similar geographic, meteorological and climatic circumstances for forestry.

In the following paragraph, a short summary of the methods used is given for each sector.

1 Energy

- Emissions from 1A Fuel Combustion Activities: Activity data is taken from the National Energy Statistics (including consistency modifications) and from census for the fuel sales of gasoline and diesel oil. The methods are country specific.
- Emissions from 1B Fugitive Emissions from Fuels: The Swiss method is applied corresponding to country specifics.

2 Industrial Processes

- HFC and PFC emissions from 2F1 Refrigeration and Air Conditioning Equipment are reported and are calculated with the rule of proportion applied on the Swiss emissions using country specific activity data as representative for the conversion (e.g. no. of inhabitants).
- SF₆ emissions from 2F8 Electrical Equipment are reported based on country specific data.

- CO and NMVOC emissions from 2A5 Asphalt Roofing and 2A6 Road Paving with Asphalt. The emissions are estimated from the Swiss emissions using the number of inhabitants as a reference value for the rough estimate of Liechtenstein's emissions.
- Other emissions from industrial processes (CO₂, CH₄, N₂O) are not occurring.

3 Solvent and Other Product Use

- Emissions 3A-3D: the emissions are estimated from the Swiss emissions using the number of inhabitants as a reference value for the rough estimate of Liechtenstein's emissions.

4 Agriculture

- Emissions are reported for 4A Enteric Fermentation, 4B Manure Management and 4D Agricultural Soils by applying Swiss methods (country specific) combined with Liechtenstein specific Activity Data as far as available.

5 LULUCF

- Emissions and removals are reported for 5A to 5F and 5(III). Most of the methods and the emission factors are adopted from Switzerland (country specific).

6 Waste

- Emissions are modelled by applying the following methods: 6A T2, 6B CS (CH₄) and D (N₂O), 6C T2 and 6D CS.

1.4.1.2 Specific Assumptions for the Year 2011

For the modelling of its emission, Liechtenstein uses several emission factors originate from the Swiss GHG inventory. Important examples are the implied emission factors for 1A3b Road Transportation. Currently, the emissions 2011 of the Swiss inventory 2013 are not available yet in their final version, therefore the implied emission factors 2011 are not available either. For the time being, as annual variation of the Swiss implied emission factors is very small, **implied emission factors 2010 are used as a preliminary estimate for the implied emission factors 2011**. The following sectors are concerned

- Energy: 1A3b
- Ind. Process: 2A5–2A6, 2F1–2F8
- Solvent and other Product Use: 3A, 3B, 3C, 3D
- Agriculture: 4A, 4B, 4D

For the submission in April 2014, the emissions 2011 will be recalculated for the above categories using the final Swiss implied emission factors 2011.

The number of inhabitants of Liechtenstein for the year 2011 is preliminary and the finalized data set is not published yet. For the submission 2013 preliminary numbers are used and if required available from Acontec .

Table 1-1 Notation keys for applied methods and emission factors (see also CRF tables Summary3s1, Summary3s2).

GREENHOUSE GAS SOURCE AND SINK CATEGORIES	CO ₂		CH ₄		N ₂ O	
	Method applied	Emission factor	Method applied	Emission factor	Method applied	Emission factor
1. Energy	CS,T1,T2	CS	CS,T1,T2,T3	CS,D	CS,T1,T2,T3	CS,D
A. Fuel Combustion	CS,T1,T2	CS	CS,T1,T2,T3	CS,D	CS,T1,T2,T3	CS,D
1. Energy Industries	T2	CS	T2	CS	T2	CS,D
2. Manufacturing Industries and Construct	T2	CS	T2	CS	T2	D
3. Transport	T1	CS	T3	CS,D	T3	CS,D
4. Other Sectors	CS,T1,T2	CS	CS,T1,T2	CS	CS,T1,T2	CS,D
5. Other	T1	CS	T1	CS	T1	CS
B. Fugitive Emissions from Fuels	NA	NA	T3	CS	NA	NA
1. Solid Fuels	NA	NA	NA	NA	NA	NA
2. Oil and Natural Gas	NA	NA	T3	CS	NA	NA
2. Industrial Processes	NA	NA	NA	NA	NA	NA
A. Mineral Products	NA	NA	NA	NA	NA	NA
B. Chemical Industry	NA	NA	NA	NA	NA	NA
C. Metal Production	NA	NA	NA	NA	NA	NA
D. Other Production	NA	NA				
E. Production of Halocarbons and SF ₆						
F. Consumption of Halocarbons and SF ₆						
G. Other	NA	NA	NA	NA	NA	NA
3. Solvent and Other Product Use	CS	CS			CS	CS
4. Agriculture			T2	CS,D	CS,T1b	D
A. Enteric Fermentation			T2	CS		
B. Manure Management			T2	D	CS	D
C. Rice Cultivation			NA	NA		
D. Agricultural Soils			NA	NA	CS,T1b	D
E. Prescribed Burning of Savannas			NA	NA	NA	NA
F. Field Burning of Agricultural Residues			NA	NA	NA	NA
G. Other			NA	NA	NA	NA
5. Land Use, Land-Use Change and Forestry	T2	CS	NA	NA	T2	CS
A. Forest Land	T2	CS	NA	NA	NA	NA
B. Cropland	T2	CS	NA	NA	T2	CS
C. Grassland	T2	CS	NA	NA	NA	NA
D. Wetlands	T2	CS	NA	NA	NA	NA
E. Settlements	T2	CS	NA	NA	NA	NA
F. Other Land	T2	CS	NA	NA	NA	NA
G. Other	NA	NA	NA	NA	NA	NA
6. Waste	T2	CS	CS,T2	CS	CS,D,T2	CS,D
A. Solid Waste Disposal on Land	NA	NA	T2	CS		
B. Waste-water Handling			CS	CS	D	D
C. Waste Incineration	T2	CS	T2	CS	T2	CS
D. Other	NA	NA	CS	CS	CS	CS
7. Other (as specified in Summary 1.A)	NA	NA	NA	NA	NA	NA

2. Industrial Processes	HFCs		PFCs		SF ₆	
	Method applied	Emission factor	Method applied	Emission factor	Method applied	Emission factor
E. Production of Halocarbons and SF ₆	NA	NA	NA	NA	NA	NA
F. Consumption of Halocarbons and SF ₆	CS	CS,D	CS	CS	T3	CS

1.4.1.3 Reference Approach for the Energy Sector

Liechtenstein carried out the Reference Approach to estimate energy consumption and CO₂ emissions for the energy sector. The results are shown in Chapter 3.2.1..

1.4.2 KP-LULUCF Inventory

The information in this Inventory is provided in accordance with Decision 15/CP.10 (FCCC/CP/2004/10/Add.2) and based on the information given in Liechtenstein's Initial Report (OEP 2006a) and the Corrigendum to the Initial Report of 19 Sep 2007 (OEP 2007b).

According to paragraph 25 of the annex to decision 13/CMP.1, Liechtenstein had to determine for each activity of the LULUCF sector whether removal units (RMUs) shall be issued annually or for the entire commitment period. Liechtenstein has chosen to **account annually** for emissions and removals from the LULUCF sector (see Chapter 7 of the Initial Report OEP 2006a). The decision remains fixed for the entire first commitment period.

Liechtenstein adopts the forest definition of the Swiss Land Use Statistics (AREA) of the Swiss Federal Statistical Office. AREA provides an excellent data base to derive accurate, detailed information not only for forest areas, but for all types of land use and land cover. Thus, AREA offers a comprehensive, consistent and high quality data set to estimate the surface area of the different land use categories in reporting under the Kyoto Protocol. For Liechtenstein, the Land Use Statistics has been built up identically to Switzerland (same method and data structures, same realisation).

The following forest definition has been used (OEP 2007b):

- • minimum area of land: 0.0625 hectares (with a minimum width of 25 m)
- • minimum crown cover: 20 per cent
- • minimum height of the dominant trees: 3 m (dominant trees must have the potential to reach 3 m at maturity in situ)

In extension of the method applied for the LULUCF sector, KP-LULUCF requires the distinction between human-induced deforestation and non-human-induced changes of forest land into other land categories. Deforestation data are taken from Liechtenstein's official deforestation statistics ("Rodungsstatistik"), as deforestation is generally prohibited by law and every deforestation in Liechtenstein has therefore to be authorised (see also 11.1.1.1).

1.5 Brief Description of Key Categories

The key category analysis (KCA) is performed according to the IPCC Good Practice Guidance (IPCC 2000, Chapter 7) and the IPCC Good Practice Guidance for Land Use, Land-Use Change and Forestry (IPCC 2003, Chapter 5.4). The used methodology is a Tier 1 level and trend assessment with the proposed threshold of 95%. The analysis is performed four times:

- Base year 1990 without LULUCF categories
- Base year 1990 with LULUCF categories
- Reporting year 2011 without LULUCF categories
- Reporting year 2011 with LULUCF categories

1.5.1 GHG Inventory

1.5.1.1 KCA without LULUCF categories

For 2011, among a total of 123 categories, 16 have been identified as key categories with an aggregated contribution of 95.7% of the national total emissions (see Table 1-2). 16 categories are key categories due to level assessment and 12 categories are due to trend assessment (see Table 1-3).

From 16 key categories, 11 are from the energy sector, contributing 82.3% to total CO₂ equivalent emissions in 2011. The other key categories are from the sectors Industrial Processes (3.9%) and Agriculture (9.5%).

There are five major sources which contribute together 65.1% of the key sources:

- 1A3b Energy, Fuel Combustion, Road Transportation, Gasoline: CO₂, level contribution 20.0%.
- 1A3b Energy, Fuel Combustion, Road Transportation, Diesel: CO₂, level contribution 14.0%.
- 1A4a Energy, Fuel Combustion, Other Sectors, Commercial/Institutional, Liquid Fuels: CO₂, level contribution 12.2%.
- 1A4b Energy, Fuel Combustion, Other Sectors, Residential, Gaseous Fuels: CO₂, level contribution 10.3%.
- 1A4a Energy, Fuel Combustion, Other Sectors, Commercial/Institutional, Gaseous Fuels: CO₂, level contribution 8.6%.

Compared to the previous submission for the reporting year 2010, one additional category is key in 2011:

- 4B Agriculture Manure Management, CH₄

Further details are shown Table 1-2 below, and the complete Key Category Analysis is provided in Annex 1.1.

For the base year 1990, the level analysis is given in Table 1-3 below. There are 13 level key categories. Compared to the previous submission, one additional category is key category in 1990:

- 4B Agriculture Manure Management, CH₄

Compared to the KCA analysis for 1990, three additional categories are key categories in the KCA analysis for 2011:

- 1A1 Energy, Fuel Combustion, Energy Industries, Gaseous Fuels, CO₂
- 1A3b Energy, Fuel combustion, Road Transportation, Gaseous Fuels, CO₂
- 2F Industrial Processes, Consumption of Halocarbons and SF₆, HFC

Table 1-2 List of Liechtenstein's 16 key categories 2011. Sorted by contribution in level.

Key Category Analysis 2011 (without LULUCF)					Direct GHG	Share of Total Emissions	Cumulative Total	Result of assessment
IPCC Source Categories (and fuels if applicable)								
1A3b	1. Energy	A. Fuel Combustion	3. Transport; Road Transportation	Gasoline	CO ₂	20.0%	20.0%	KC Level & KC Trend
1A3b	1. Energy	A. Fuel Combustion	3. Transport; Road Transportation	Diesel	CO ₂	14.0%	34.0%	KC Level & KC Trend
1A4a	1. Energy	A. Fuel Combustion	4. Other Sectors; Commercial/Institutional	Liquid Fuels	CO ₂	12.2%	46.2%	KC Level & KC Trend
1A4b	1. Energy	A. Fuel Combustion	4. Other Sectors; Residential	Gaseous Fuels	CO ₂	10.3%	56.5%	KC Level & KC Trend
1A4a	1. Energy	A. Fuel Combustion	4. Other Sectors; Commercial/Institutional	Gaseous Fuels	CO ₂	8.6%	65.1%	KC Level & KC Trend
4A	4. Agriculture	A. Enteric Fermentation			CH ₄	4.8%	70.0%	KC Level
1A2	1. Energy	A. Fuel Combustion	2. Manufacturing Industries and Construction	Gaseous Fuels	CO ₂	4.7%	74.6%	KC Level & KC Trend
1A4b	1. Energy	A. Fuel Combustion	4. Other Sectors; Residential	Liquid Fuels	CO ₂	4.0%	78.7%	KC Level & KC Trend
1A2	1. Energy	A. Fuel Combustion	2. Manufacturing Industries and Construction	Liquid Fuels	CO ₂	4.0%	82.7%	KC Level & KC Trend
2F	2. Industrial Proc.	F. Consumption of Halocarbons and SF ₆			HFC	3.9%	86.6%	KC Level & KC Trend
4D1	4. Agriculture	D. Agricultural Soils; Direct Soil Emissions			N ₂ O	2.5%	89.1%	KC Level
1A5	1. Energy	A. Fuel Combustion	5. Other	Liquid Fuels	CO ₂	1.8%	90.9%	KC Level & KC Trend
1A3b	1. Energy	A. Fuel Combustion	3. Transport; Road Transportation	Gaseous Fuels	CO ₂	1.4%	92.3%	KC Level & KC Trend
1A1	1. Energy	A. Fuel Combustion	1. Energy Industries	Gaseous Fuels	CO ₂	1.3%	93.6%	KC Level & KC Trend
4D3	4. Agriculture	D. Agricultural Soils; Indirect Emissions			N ₂ O	1.2%	94.8%	KC Level
4B	4. Agriculture	B. Manure Management			CH ₄	0.9%	95.7%	KC Level

Table 1-3 List of Liechtenstein's 13 key categories in 1990. Sorted by contribution in level.

Key Category Analysis 1990 (without LULUCF) IPCC Source Categories (and fuels if applicable)					Direct GHG	Share of Total Emissions	Cumulative Total	Result of assessment
1A3b	1. Energy	A. Fuel Combustion	3. Transport; Road Transportation	Gasoline	CO2	26.3%	26.3%	KC Level
1A4a	1. Energy	A. Fuel Combustion	4. Other Sectors; Commercial/Institutional	Liquid Fuels	CO2	24.8%	51.1%	KC Level
1A2	1. Energy	A. Fuel Combustion	2. Manufacturing Industries and Construction	Liquid Fuels	CO2	8.1%	59.2%	KC Level
1A4b	1. Energy	A. Fuel Combustion	4. Other Sectors; Residential	Liquid Fuels	CO2	8.1%	67.3%	KC Level
1A2	1. Energy	A. Fuel Combustion	2. Manufacturing Industries and Construction	Gaseous Fuels	CO2	7.2%	74.5%	KC Level
1A3b	1. Energy	A. Fuel Combustion	3. Transport; Road Transportation	Diesel	CO2	6.4%	80.9%	KC Level
4A	4. Agriculture	A. Enteric Fermentation			CH4	4.5%	85.4%	KC Level
1A4a	1. Energy	A. Fuel Combustion	4. Other Sectors; Commercial/Institutional	Gaseous Fuels	CO2	3.8%	89.2%	KC Level
4D1	4. Agriculture	D. Agricultural Soils; Direct Soil Emissions			N2O	2.4%	91.6%	KC Level
4D3	4. Agriculture	D. Agricultural Soils; Indirect Emissions			N2O	1.2%	92.8%	KC Level
1A4b	1. Energy	A. Fuel Combustion	4. Other Sectors; Residential	Gaseous Fuels	CO2	1.1%	93.9%	KC Level
1A5	1. Energy	A. Fuel Combustion	5. Other	Liquid Fuels	CO2	1.0%	94.9%	KC Level
4B	4. Agriculture	B. Manure Management			CH4	0.9%	95.8%	KC Level

1.5.1.2 KCA including LULUCF categories

According to IPCC Good Practice Guidance for LULUCF (IPCC 2003), Section 5.4.2, the set of key categories consists of all non-LULUCF key categories that result from the KCA without LULUCF combined with all LULUCF-key-categories that result from the KCA with LULUCF.

The KCA 2011 including LULUCF categories, consists of a total of 137 categories. 22 of them are key categories and six are from the LULUCF sector and contribute with a total of 12.2% to total emissions:

- 5A1 Forest Land remaining Forest Land, CO₂ (7.2%)
- 5A2 Forest Land, Land converted to Forest Land, CO₂ (0.6%)
- 5B1 Cropland remaining Cropland, CO₂ (1.7%)
- 5C2 Land converted to Grassland, CO₂ (0.8%)
- 5E2 Land converted to Settlements, CO₂ (1.4%)
- 5F2 Land converted to Other Land, CO₂ (0.5%)

Compared to the Key Category Analysis in the previous submission for the reporting year 2010, there is one LULUCF category which is not a key category any more:

- 5C1 Grassland remaining Grassland, CO₂.

Three categories are new key categories in 2011:

- 5A2 Forest Land, Land converted to Forest Land, CO₂
- 5C2 Land converted to Grassland, CO₂
- 5F2 Land converted to Other Land, CO₂

Further details are shown Table 1-4, and the complete Key Category Analysis is provided in Annex 1.2.

In the KCA 1990 including LULUCF categories, 17 categories appear as key categories. Four of the key categories are from the LULUCF sector. Compared to the KCA analysis 2010 for 1990 including LULUCF, one additional LULUCF category is a key category:

- 5A2 Forest Land, Land converted to Forest Land, CO₂.

Compared to the KCA analysis for 1990, two additional LULUCF categories are key categories in the KCA analysis for 2011:

- 5C2 Land converted to Grassland, CO₂
- 5F2 Land converted to Other Land, CO₂

Table 1-4 Liechtenstein's key categories in 2011 and in 1990 combined without and with LULUCF categories

Key Category Analysis 2011 (including LULUCF)					Direct GHG	Share of Total Emissions
IPCC Source Categories (and fuels if applicable)						
1A1	1. Energy	A. Fuel Combustion	1. Energy Industries	Gaseous Fuels	CO ₂	1.1%
1A2	1. Energy	A. Fuel Combustion	2. Manufacturing Industries and Construction	Gaseous Fuels	CO ₂	4.1%
1A2	1. Energy	A. Fuel Combustion	2. Manufacturing Industries and Construction	Liquid Fuels	CO ₂	3.5%
1A3b	1. Energy	A. Fuel Combustion	3. Transport; Road Transportation	Gasoline	CO ₂	17.4%
1A3b	1. Energy	A. Fuel Combustion	3. Transport; Road Transportation	Diesel	CO ₂	12.2%
1A3b	1. Energy	A. Fuel Combustion	3. Transport; Road Transportation	Gaseous Fuels	CO ₂	1.2%
1A4a	1. Energy	A. Fuel Combustion	4. Other Sectors; Commercial/Institutional	Liquid Fuels	CO ₂	10.7%
1A4a	1. Energy	A. Fuel Combustion	4. Other Sectors; Commercial/Institutional	Gaseous Fuels	CO ₂	7.5%
1A4b	1. Energy	A. Fuel Combustion	4. Other Sectors; Residential	Gaseous Fuels	CO ₂	8.9%
1A4b	1. Energy	A. Fuel Combustion	4. Other Sectors; Residential	Liquid Fuels	CO ₂	3.5%
1A5	1. Energy	A. Fuel Combustion	5. Other	Liquid Fuels	CO ₂	1.5%
2F	2. Industrial Proc.	F. Consumption of Halocarbons and SF6			HFC	3.4%
4A	4. Agriculture	A. Enteric Fermentation			CH ₄	4.2%
4B	4. Agriculture	B. Manure Management			CH ₄	0.8%
4D1	4. Agriculture	D. Agricultural Soils; Direct Soil Emissions			N ₂ O	2.2%
4D3	4. Agriculture	D. Agricultural Soils; Indirect Emissions			N ₂ O	1.0%
5A1	5. LULUCF	A. Forest Land	1. Forest Land remaining Forest Land		CO ₂	7.2%
5A2	5. LULUCF	A. Forest Land	2. Land converted to Forest Land		CO ₂	0.6%
5B1	5. LULUCF	B. Cropland	1. Cropland remaining Cropland		CO ₂	1.7%
5C2	5. LULUCF	C. Grassland	2. Land converted to Grassland		CO ₂	0.8%
5E2	5. LULUCF	E. Settlements	2. Land converted to Settlements		CO ₂	1.4%
5F2	5. LULUCF	F. Other Land	2. Land converted to Other Land		CO ₂	0.5%

Key Category Analysis 1990 (including LULUCF)					Direct GHG	Share of Total Emissions
IPCC Source Categories (and fuels if applicable)						
1A2	1. Energy	A. Fuel Combustion	2. Manufacturing Industries and Construction	Gaseous Fuels	CO ₂	7.2%
1A2	1. Energy	A. Fuel Combustion	2. Manufacturing Industries and Construction	Liquid Fuels	CO ₂	8.1%
1A3b	1. Energy	A. Fuel Combustion	3. Transport; Road Transportation	Diesel	CO ₂	6.4%
1A3b	1. Energy	A. Fuel Combustion	3. Transport; Road Transportation	Gasoline	CO ₂	26.3%
1A4a	1. Energy	A. Fuel Combustion	4. Other Sectors; Commercial/Institutional	Gaseous Fuels	CO ₂	3.8%
1A4a	1. Energy	A. Fuel Combustion	4. Other Sectors; Commercial/Institutional	Liquid Fuels	CO ₂	24.8%
1A4b	1. Energy	A. Fuel Combustion	4. Other Sectors; Residential	Gaseous Fuels	CO ₂	1.1%
1A4b	1. Energy	A. Fuel Combustion	4. Other Sectors; Residential	Liquid Fuels	CO ₂	8.1%
1A5	1. Energy	A. Fuel Combustion	5. Other	Liquid Fuels	CO ₂	1.0%
4A	4. Agriculture	A. Enteric Fermentation			CH ₄	4.5%
4B	4. Agriculture	B. Manure Management			CH ₄	0.9%
4D1	4. Agriculture	D. Agricultural Soils; Direct Soil Emissions			N ₂ O	2.4%
4D3	4. Agriculture	D. Agricultural Soils; Indirect Emissions			N ₂ O	1.2%
5A1	5. LULUCF	A. Forest Land	1. Forest Land remaining Forest Land		CO ₂	6.9%
5A2	5. LULUCF	A. Forest Land	2. Land converted to Forest Land		CO ₂	0.8%
5B1	5. LULUCF	B. Cropland	1. Cropland remaining Cropland		CO ₂	1.6%
5E2	5. LULUCF	E. Settlements	2. Land converted to Settlements		CO ₂	1.3%

1.5.2 KP-LULUCF Inventory

As stated in the IPCC Good Practice Guidance for LULUCF (IPCC 2003), the basis for assessment of key categories under Articles 3.3 and 3.4 of the Kyoto Protocol is the same as the assessment made for the UNFCCC inventory. Note that Liechtenstein has elected to not account for LULUCF activities under Article 3.4 during the first commitment period (OEP 2006a). Therefore only the categories afforestation/reforestation and deforestation are reported for the KP Inventory.

Among the key categories from the LULUCF sector in the UNFCCC inventory, there are five categories which have a relationship to afforestation/reforestation or deforestation, according to table 5.4.4 in the IPCC Good Practice Guidance for LULUCF:

- 5B2 Land converted to Cropland: related to deforestation
- 5C2 Land converted to Grassland: related to deforestation
- 5D2 Land converted to Wetlands: related to deforestation
- 5E2 Land converted to Settlements: related to deforestation
- 5F3 Land converted to Other Land: related to deforestation

Afforestation occurs in more than one category of the UNFCCC inventory. As recommended by the IPCC Good Practice Guidance for LULUCF, in this case the total emissions and removals from the activity are considered for purposes of the key category analysis. The total from the activity afforestation in 2011, as reported with the present submission, is a removal of 0.18 Gg CO₂. The smallest category which is identified as key in the UNFCCC inventory (combined KCA without and with LULUCF categories) is 4D3 Indirect Emissions from Agricultural Soils with 2.59 Gg CO₂ emissions. This means that the total for afforestation is smaller than the emissions from the smallest category that is identified as key in the UNFCCC inventory. Therefore Afforestation is not considered to be a key category. Similarly deforestation on the other hand with 0.39 Gg CO₂ emissions, is greater than the emissions from 4D3 and therefore considered as key category.

1.6 Quality Assurance and Quality Control (QA/QC) Including Verification and Confidentiality Issues

1.6.1 QA/QC Procedures

1.6.1.1 Terms and objectives

According to the IPCC Good Practice Guidance (IPCC 2000) the major elements of a QA/QC system are:

- an inventory agency responsible for coordinating QA/QC activities;
- a QA/QC plan;
- QC procedures;
- QA review procedures;
- reporting, documentation, and archiving procedures.

The implementation status of these quality elements is described in the following chapters. One has to note that Liechtenstein's QA/QC system accounts for the **specific circumstances of the Principality of Liechtenstein**: Due to the smallness of the State, not every process, data flow and arrangement needs to be established by a formal agreement due to short "distances" within the administration and due to a high degree of acquaintance between the persons involved. Therefore, the National System manages with little number of written documents.

1.6.1.2 Objectives of the quality system

The quality management shall enable the party to principally fulfil the requirements of the articles 3, 5 and 7 of the Kyoto Protocol. Specifically, it shall ensure and improve the quality

of GHG inventory that means a continuous improvement **of transparency, consistency, comparability, completeness and confidence**. In detail, it serves

- for providing checks to ensure data integrity, correctness and completeness;
- to identify errors and omissions,
- to reduce the uncertainties of the emission estimates,
- to document and archive inventory material.

1.6.1.3 Responsible agency for coordinating QA/QC activities

The QA/QC activities are coordinated by the quality manager of the GHG Inventory Group. The responsible person is Mr. Andreas Gstoehl, head of the unit Air Pollution Control, Noise and Climate (e-mail: Andreas.Gstoehl@aus.llv.li, phone: +423 236 61 86) in the Office of the Environment (OE). The QA/QC activities are organised within the Inventory Group, see National System represented in Figure 1-1.

Operational tasks are delegated to the lead NIR author. He distributes checklists to the project manager being also the National Inventory Compiler, to the sectoral experts, and to other NIR authors. They fill in the procedures that they carried out. The lists are then sent back to the quality manager, who confirms the performance of the QA/QC activities. The activities are documented in the NIR (see Annex 8).

1.6.1.4 QC procedures

Quality control (QC) is defined by: "System of routine technical activities to measure and control the quality of the inventory as it is being developed." (IPCC 2000).

Overall Activities

The following QC activities are carried out:

- The annual cycle for inventory preparation contains several meetings of the Inventory Group and several meetings of governmental and other data suppliers with the OE. In these meetings the activities, responsibilities and schedule for the inventory preparation process are being organised and determined.
- Regular meetings of the group "Umwelt und Raum" (environment and spatial planning). The group is formed by the heads of the OE, SLP and the minister for the environment. It prepares policy matters for the attention of the Government including climate affairs.
- The project manager, also operating as the national inventory compiler (NIC), the sectoral experts, and the NIR authors accomplish a number of QC activities:

The NIR authors check the emission results produced by the sectoral experts, for consistency of cross-cutting parameters, correctness of emissions aggregation, and completeness of the GHG inventory. They compare the methods used with IPCC Good Practice Guidance, check the correct compiling of the methods in the NIR, the correct transcription of CRF data into NIR data tables and figures, the consistency between data tables and text in the NIR, and the completeness of references in the NIR. Furthermore, they are responsible for the correctness of the key source and the uncertainty analysis.

The sectoral experts check the description of methods, numbers and figures in the NIR.

The NIC checks the integrity of the database files, the consistency of time series, the correct and complete inputs into the CRF Reporter.

Further staff members of the OE carry out a proof reading of single sectors.

The project manager executes an overall checking function for the GHG inventory and the NIR: he monitors the GHG emission modelling and the key category analysis. He checks the NIR for correctness, completeness, transparency and quality, checks for the complete archiving of documents, and the completeness of the CRF submission document.

It may be mentioned that the OE enlarged its staff of the Climate Protection unit in the beginning of 2007 by two more collaborators. They are responsible for emission modelling, GHG inventory, implementation of the emission trading system, national emissions trading registry, national allocation plan, Kyoto mechanisms (JI, CDM).

In order to provide an overview and to increase transparency, all authors, experts, and involved staff members of Liechtenstein's government are listed in a separate table together with specific descriptions about their responsibilities. This table is available for the entire reporting period and helps to improve the QC management in general.

Specific activity

The CRF tables exported from the CRF Reporter software underwent an iterative quality control in a triple check:

- The results for 2011 were compared with the results 2010 within the current CRF,
- the results for 2010 were compared between the current CRF tables and the CRF tables of submission 2012,
- the results for the base year 1990 were compared between the current CRF tables and the CRF tables of submission 2012.

For each check, the CRF table cells were labelled in green if values were identical, in grey if they differed by no more than 20%, in orange if they differed by 20% to 50%, and in red if they differed by more than 50%. The findings were discussed among the core group members and the modelling specialists. All differences were investigated and the reasons for the differences sought. This procedure led to the identification of several errors, which were subsequently corrected before submission.

1.6.1.5 Documentation of the QC Activities

For the submission 2008, the QC activities had been documented for the first time by using of checklists. The lists are updated for the current submission and are shown in the Annex 8. The classification of the QC activities follows the IPCC GPG table 8.1 (IPCC 2000). The following persons are involved in the QC activities:

- Sectoral experts for energy, industrial processes etc.
- NIC / Project manager
- NIR authors

Special attention of the QC activities for emissions has been directed to the key categories.

1.6.1.6 QA Review Procedures

Quality assurance (QA): System of activities that include a "system of review procedures conducted by personnel not directly involved in the inventory compilation development process, to verify that data quality objectives were met, ensure that the inventory represents the best possible estimate of emissions and sinks given the current state of scientific knowledge and data available, and support the effectiveness of the QC programme" (IPCC 2000).

Liechtenstein's NIS quality management system follows a Plan-Do-Check-Act-Cycle (PDCA-cycle), which is a generally accepted model for pursuing a systematic quality performance according to international standards. This approach is in accordance with procedures described in decision 19/CMP.1 and in the IPCC Good Practice Guidance.

Liechtenstein carries out the following QA activities:

- Internal review: The draft NIR is passing through an internal review. The project manager also being the NIC, the project manager assistant, two specialised staff members of the climate unit, and other staff member of the OE are proofreading the NIR or parts of it (personnel not directly involved in the preparation of a particular section of the inventory). They document their findings in checklists, which are sent back to the NIR authors (see Annex 8).
- The Swiss inventory management charges external experts for sectoral QA activities to review the Swiss GHG inventory. Since a number of Swiss methods and Swiss emission factors are used for the preparation of the Liechtenstein inventory, the results of the Swiss QA activities have to be checked and analysed by Liechtenstein's experts. Positive reviews may be interpreted as positive for Liechtenstein too, and problematic findings must not only be taken account for in Switzerland but also in Liechtenstein. The following sectors have already been reviewed:

A consulting group (not involved in the GHG emission modelling) was mandated to review the two sectors Energy and Industrial Processes with respect to methods, activity data, emission factors, CRF tables, NIR chapter (Eicher and Pauli 2006). The results were documented in a review report and communicated to Liechtenstein's Inventory Group. The consequences for the main findings have been evaluated for Liechtenstein's GHG inventory and for the NIR for submission December 2006.

The Swiss Federal Institute of Technology was mandated to review the methane emissions of agriculture with respect to methods, activity data and emission factors. The results were documented in two reports (Soliva 2006a, 2006b) and communicated to Liechtenstein's Inventory Group. The consequences for the main findings have been evaluated for Liechtenstein's GHG inventory and for the NIR for submission December 2006.

The waste sector of Switzerland was reviewed by a peer expert group in 2009. The reviewers conclude that waste related emissions are calculated in a plausible way and that results from the report are plausible. The emission factors as well as activity data are based on reliable and solid sources. For details see Ryttec (2010)

An expert peer review of the LULUCF sector of the Swiss GHG inventory took place in 2010. The reviewers conclude that "LULUC sector of the Swiss green house gas inventory proved to be of superior quality, good applicatory characteristics and scientifically sound applied definitions and methodology". For details see VTI (2010).

For the Swiss NIR, an internal review takes place annually shortly before the submission. Every chapter of the NIR is being proofread by specialists not involved in the emission modelling or in the NIR editing. The internal review is organised by the quality officer and the results are compiled by the same person that is also compiling Liechtenstein's NIR (lead author J. Heldstab, INFRAS). The results of the Swiss review are therefore communicated to Liechtenstein's Inventory Group. Where methods and results are concerned that are relevant for Liechtenstein too, the consequences were taken into account. This procedure has been performed in the last and the current submissions (May and December 2006, May 2007, February 2008, April 2009, April 2010, April 2011, April 2012). It will also be repeated for future submissions.

- The applicability of Swiss methodologies and emission factors to Liechtenstein's GHG inventory was reviewed as well: Before Swiss methods were applied, they were discussed with the experts of Liechtenstein's administration. This process has taken place before the submission in December 2006 for the sectors Energy, Industrial Processes, Solvent and Other Product Use, Agriculture and Waste, for the sector

LULUCF before the submission in February 2008. Since then, the issue is a permanent point on the agenda of the annual kick-off meetings of the Inventory Group: Potential modifications or updates of the Swiss emission factors are discussed and checked upon their applicability for Liechtenstein's GHG inventory

- For the sector LULUCF a new external reviewer has been mandated in 2012. The entire LULUCF sector has been revised and brought in line with the IPCC methodology.

1.6.1.7 Archiving Procedures

The electronic files of Liechtenstein's GHG inventory are all saved by the backup system of Liechtenstein's administration.

Every computer belonging to the administration, including the computers of the Office of the Environment, are connected to a central network. The data of the server systems, file-clusters and database servers, are being saved in a tape-library. Due to safety reasons, the tape-library is not in the computing centre but in a building of the National police: In case of a total loss of the computing centre, the data are still available.

There are several backups

- daily incremental saved up to one month (4 weeks)
- Weekly full backup saved up to two months
- Monthly full backup saved up to one year

The backup files are being initialised via scheduler of the master server. The data are written via network onto one of the LTO 2 Drives (tape). The master server manages the handling of the tapes. Backups are checked daily via Activity Monitor. If a backup is not carried out, it may be caught up manually. Since daily restores of user data is carried out, there is a guarantee for keeping the data readable.

For archiving reasons, the backup tapes are being doubled four times a year. The duplicates are not being overwritten during five years.

In addition to the administrative archiving system, the external experts of Acontec AG, who are mandated with the emission modelling and CRF generation, save all CRF and background tables yearly on CD ROM/DVD ROM. Also the data generated in the NIR compilation process such as QA/QC, KCA, uncertainty analysis, review documents are saved on DVD by INFRAS. The disks are stored in a bank safe of the Liechtensteinische Landesbank (Liechtenstein's National Bank).

The information exchange by email between all NIR participants is stored for the submission 2013 in the so-called PST format.

Therefore archiving practices are in line with paragraph 16(a) of the annex to decision 19/CMP.1

1.6.2 Verification Activities

Verification Activities have taken place in various steps of the development of the Inventory. As Liechtenstein compiles its Inventory in close collaboration with Switzerland concerning methods and models used, there is a continuous international comparison between the two Inventories going on.

The same emission factors as in the Swiss NIR are applied. Therefore, those factors are basically checked when copied from the Swiss NIR and correlation thus depends on the

activity data. As both countries have used similar methodologies, comparable economic structure, similar liquid/gaseous fuels mixes and vehicle fleet composition, the comparison of total per capita CO₂ emission indicates completeness of source categories.

If the national total emissions (without LULUCF) of the two countries are compared, very similar and highly correlated trends may be found. In 1990, Liechtenstein's emissions were 0.44% of the Swiss emissions. After a slight increase in past years up to 0.46%, the share in 2011 reached again 0.44%. In the same period, the share of inhabitants increased slightly from 0.43% to 0.46%. This correlation may be interpreted as a simple form of verification, since Liechtenstein has used the same or similar Methods and EF for many sectors.

Another indirect verification may be derived from the ambient air pollutant concentration measurements. Liechtenstein is integrated in a monitoring network of the Eastern cantons of Switzerland (www.ostluft.ch). The results are commonly analysed and published (Ostluft 2011). They show that the local air pollution levels of NO₂, O₃, PM10 in Liechtenstein vary in the same range as in the Swiss neighbouring measurement sites.

1.6.3 Treatment of Confidentiality Issues

In Liechtenstein all Activity Data and Emission Factors are publicly available and not subject to confidentiality treatment.

1.7 Uncertainty Evaluation

1.7.1 GHG Inventory

1.7.1.1 Data Used

Data on uncertainties is not provided explicitly for most key data sources. In this situation, the authors of the NIR chapters together with the involved experts generated first estimates of uncertainties based on IPCC Good Practice Guidance default values, uncertainty data from the Swiss NIR (FOEN 2012) and expert estimates.

All uncertainty figures are to be interpreted as corresponding to half of the 95% confidence interval. Distributions are assumed to be symmetric for Tier 1 analysis.

Uncertainties in the GWP-values were not taken into account in the inventory uncertainty estimates.

1.7.1.2 Uncertainty Estimates

For key categories individual uncertainties are used. For non-key categories the NIR provides qualitative estimates of uncertainties. The terms used are high, medium and low data quality. In order to extend the quantitative uncertainty analysis to every non-key category the default values of applied combined uncertainty presented in Table 1-5 are used. They are motivated by the comparison of uncertainty analyses of several countries carried out by de Keizer et al. (2007), as presented at the 2nd Internat. Workshop on Uncertainty in Greenhouse Gas Inventories (Vienna 27-28 Sep 2007), and by Table A1-1 of IPCC Guidelines, Vol. 1, Annex 1, Managing uncertainties (IPCC 1996).

Table 1-5 Semi-quantitative uncertainties (2σ) for non-key categories.

Gas	Uncertainty category	Relative uncertainty
CO ₂	low	2%
	medium	10%
	high	40%
CH ₄	low	15%
	medium	30%
	high	60%
N ₂ O	low	40%
	medium	80%
	high	150%
HFC	medium	20%
PFC	medium	20%
SF ₆	medium	20%

1.7.1.3 Results for Tier 1 Uncertainty Evaluation

A quantitative uncertainty analysis has been carried out following IPCC Good Practice Guidance Tier 1 methodology (IPCC 2000, p. 6.13ff.). First, uncertainties of activity data and emission factors are estimated separately. The combined uncertainty for each source is then calculated using a Rule B approximation (IPCC 2000 p. 6.12). Finally, the Rule A approximation is used to obtain the overall uncertainty in national emissions and the trend in national emissions between the base year and the current year. For the uncertainty analysis with LULUCF, uncertainties of the LULUCF categories from Switzerland are applied.

Details on the uncertainty estimates of specific sources are provided in the sub-sections on "Uncertainties and Time-Series Consistency" in each of the chapters on source categories.

The resulting Tier 1 uncertainty in the national total annual CO₂ equivalent emissions **without LULUCF** is estimated to be 5.10% (level uncertainty). Trend uncertainty is 5.75%.

The resulting Tier 1 **total inventory uncertainty** in the national total annual CO₂ equivalent emissions **including LULUCF** sector is estimated to be 5.28% (level uncertainty). Trend uncertainty is 5.19%.

The results for calculations without and with LULUCF is lower compared to the previous submission. The uncertainty calculation of the previous submission for the emissions without LULUCF resulted in 6.45% level uncertainty and 8.43% trend uncertainty. For emissions including LULUCF, uncertainty calculations resulted in 7.20% level uncertainty and 8.52% trend uncertainty (OEP 2012a). The reason for this decrease is a decrease in the activity data for liquid fuels.

The overall uncertainty is still determined by the rather high activity data uncertainty of liquid fuels. This is due to the fact that Liechtenstein, forming a customs and monetary union with Switzerland, has no own customs statistics of imports of oil products, and activity data has to be based on soundings with suppliers, being of heterogeneous quality.

Please note that the current results of the Tier 1 uncertainty analysis for GHG emissions from key sources in Liechtenstein do not (fully) take into account the following factors that may further increase uncertainties:

- Correlations that exist between source categories that have not been considered.
- Uncertainties due to the assumption of constant parameters, e.g. of constant net calorific values for fuels for the entire period since 1990.
- Uncertainties due to methodological shortcomings, such as differences between sold fuels and actually combusted fuels (stock-changes in residential tanks) for liquid fossil fuels.

Table 1-6 Tier 1 Uncertainty ranked combined level uncertainties for sources in Liechtenstein, 2011 (IPCC 2000)

IPCC GPG Table 6.1
Tier 1 Uncertainty Calculation and Reporting

A	B	C	D	E	F	G	H	
IPCC Source category	Gas	Base year emissions 1990	Year 2011 emissions	Activity data uncertainty	Emission factor uncertainty	Combined uncertainty	Combined uncertainty as % of total national emission in year t	
		Input data	Input data	Input data	Input data	Calc/Input		
		Gg CO2 eq	Gg CO2 eq	%	%	%	%	
5A1	5. LULUCF A. Forest Land 1. FL remaining FL	CO2	17.89	18.34	5.0	36.00	36.3	2.614
1A4a	1. Energy A. Fuel Comb. 4. Commercial/Institutional Liquid Fuels	CO2	57.10	27.15	20.0	0.50	20.0	2.131
1A3b	1. Energy A. Fuel Comb. 3. Road Transportation Diesel	CO2	14.77	31.17	15.0	0.50	15.0	1.835
1A3b	1. Energy A. Fuel Comb. 3. Road Transportation Gasoline	CO2	60.53	44.33	10.0	1.40	10.1	1.756
4D3	4. Agr. D. Agr. Soils; Indirect Emissions	N2O	2.72	2.59	31.8	154.00	157.2	1.597
4D1	4. Agr. D. Agr. Soils; Direct Soil Emissions	N2O	5.45	5.56	20.4	69.00	71.9	1.569
4A	4. Agr. A. Enteric Fermentation	CH4	10.42	10.72	6.4	17.20	18.4	0.772
5E2	5. LULUCF E. Settlements 2. Land converted to S.	CO2	3.30	3.48	20.0	50.00	53.9	0.734
1A4b	1. Energy A. Fuel Comb. 4. Other Sectors; Residential Liquid Fuels	CO2	18.74	8.97	20.0	0.50	20.0	0.704
1A2	1. Energy A. Fuel Comb. 2. Manuf. Ind. and Constr. Liquid Fuels	CO2	18.74	8.96	20.0	0.50	20.0	0.703
5B1	5. LULUCF B. Cropland 1. Cropland remaining Cropland	CO2	4.10	4.37	30.0	25.00	30.1	0.670
1A4b	1. Energy A. Fuel Comb. 4. Residential Gaseous Fuels	CO2	2.51	22.78	5.0	4.60	6.8	0.607
6B	6. Waste B. Wastewater Handling	N2O	0.79	0.97	106.1	106.07	150.0	0.570
2F	2. Ind. Proc. F. Consumption of Halocarbons and SF6	HFC	0.00	8.73	11.3	11.31	16.0	0.548
1A4a	1. Energy A. Fuel Comb. 4. Commercial/Institutional Gaseous Fuels	CO2	8.70	19.17	5.0	4.60	6.8	0.511
5C2	5. LULUCF C. Grassland 2. Land converted to Grassland	CO2	0.30	2.05	20.0	50.00	53.9	0.434
4B	4. Agr. B. Manure Management	CH4	2.16	2.02	6.4	54.10	54.5	0.431
4D_o	4. Agr. D. Agricultural Soils without 4D1-N2O & 4D3-N2O	N2O	0.99	1.10	60.2	60.22	85.2	0.367
4B	4. Agr. B. Manure Management	N2O	1.21	1.38	44.4	44.41	62.8	0.341
1A5	1. Energy A. Fuel Comb. 5. Other Liquid Fuels	CO2	2.36	3.92	20.0	0.50	20.0	0.308
1A3b	1. Energy A. Fuel Comb. 3. Road Transportation Gasoline	N2O	0.73	0.51	10.0	149.67	150.0	0.298
1A2	1. Energy A. Fuel Comb. 2. Manuf. Ind. and Constr. Gaseous Fuels	CO2	16.48	10.35	5.0	4.60	6.8	0.276
5A2	5. LULUCF A. Forest Land 2. Land converted to FL	CO2	2.10	1.62	20.0	36.00	41.2	0.262
5F2	5. LULUCF F. Other Land 2. Land converted to OL	CO2	0.44	1.15	20.0	50.00	53.9	0.243
5C1	5. LULUCF C. Grassland 1. Grassland remaining G.	CO2	1.60	1.13	20.0	50.00	53.9	0.238
3	3. Solvent and Other Product Use	CO2	1.55	0.73	56.6	56.57	80.0	0.229
1B2	1. Energy B. Fug. Emis. 2. Oil and Natural Gas	CH4	0.32	1.03	35.4	35.36	50.0	0.203
6D	6. Waste D. Other	CH4	0.40	0.58	42.4	42.43	60.0	0.136
1A4c	1. Energy A. Fuel Comb. 4. Agriculture/Forestry Liquid Fuels	CO2	1.30	1.07	20.0	0.50	20.0	0.084
3	3. Solvent and Other Product Use	N2O	0.47	0.27	56.6	56.57	80.0	0.083
1A3b	1. Energy A. Fuel Comb. 3. Road Transportation Gaseous Fuels	CO2	0.00	3.11	5.0	4.60	6.8	0.083
1A1	1. Energy A. Fuel Comb. 1. Energy Industries Gaseous Fuels	CO2	0.12	2.89	5.0	4.60	6.8	0.077
1A4b	1. Energy A. Fuel Comb. 4. Residential Biomass	CH4	0.13	0.61	20.0	22.36	30.0	0.071
6D	6. Waste D. Other	N2O	0.08	0.12	106.1	106.07	150.0	0.071
5E1	5. LULUCF E. Settlements 1. Settlm. remaining S.	CO2	0.28	0.29	20.0	50.00	53.9	0.062
1A3b	1. Energy A. Fuel Comb. 3. Road Transportation Diesel	N2O	0.03	0.09	15.0	149.25	150.0	0.054
5D2	5. LULUCF D. Wetlands 2. Land converted to Wetlands	CO2	0.16	0.22	25.0	50.00	55.9	0.048
5B2	5. LULUCF B. Cropland 2. Land converted to Cropland	CO2	0.34	0.22	20.0	50.00	53.9	0.046
1A4b	1. Energy A. Fuel Comb. 4. Other Sectors; Residential Gaseous Fuels	N2O	0.01	0.08	5.0	79.84	80.0	0.024
1A1	1. Energy A. Fuel Comb. 1. Energy Industries Biomass	N2O	0.05	0.08	20.0	77.46	80.0	0.024
1A3b	1. Energy A. Fuel Comb. 3. Road Transportation Gasoline	CH4	0.54	0.10	10.0	59.16	60.0	0.024
1A4a	1. Energy A. Fuel Comb. 4. Commercial/Institutional Liquid Fuels	N2O	0.14	0.07	20.0	77.46	80.0	0.021
1A4a	1. Energy A. Fuel Comb. 4. Commercial/Institutional Biomass	N2O	0.01	0.06	20.0	77.46	80.0	0.019
6B	6. Waste B. Wastewater Handling	CH4	0.05	0.07	42.4	42.43	60.0	0.016
1A5	1. Energy A. Fuel Comb. 5. Other Liquid Fuels	N2O	0.03	0.05	20.0	148.66	150.0	0.029
1A3b	1. Energy A. Fuel Comb. 3. Road Transportation Biomass	CH4	0.00	0.06	20.0	56.57	60.0	0.014
1A4b	1. Energy A. Fuel Comb. 4. Residential Biomass	N2O	0.01	0.04	20.0	77.46	80.0	0.013
1A3a	1. Energy A. Fuel Comb. 3. Civil Aviation	CO2	0.08	0.15	15.0	1.20	15.0	0.009
1A4b	1. Energy A. Fuel Comb. 4. Residential Liquid Fuels	N2O	0.05	0.02	20.0	77.46	80.0	0.007
1A2	1. Energy A. Fuel Comb. 2. Manuf. Ind. and Constr. Liquid Fuels	N2O	0.05	0.02	20.0	77.46	80.0	0.007
1A4c	1. Energy A. Fuel Comb. 4. Agriculture/Forestry Liquid Fuels	N2O	0.01	0.01	20.0	77.46	80.0	0.004
1A4b	1. Energy A. Fuel Comb. 4. Residential Gaseous Fuels	CH4	0.01	0.05	5.0	29.58	30.0	0.006
2F	2. Ind. Proc. F. Consumption of Halocarbons and SF6	PFC	0.00	0.07	14.1	14.14	20.0	0.006
5B2	5. LULUCF B. Cropland 2. Land converted to Cropland	N2O	0.01	0.01	6.0	90.00	90.2	0.005
6C	6. Waste C. Waste Incineration	CO2	0.03	0.03	28.3	28.28	40.0	0.005
1A4a	1. Energy A. Fuel Comb. 4. Commercial/Institutional Gaseous Fuels	CH4	0.02	0.04	5.0	29.58	30.0	0.005
1A4a	1. Energy A. Fuel Comb. 4. Commercial/Institutional Gaseous Fuels	N2O	0.00	0.01	5.0	79.84	80.0	0.003
1A1	1. Energy A. Fuel Comb. 1. Energy Industries Gaseous Fuels	CH4	0.00	0.03	5.0	29.58	30.0	0.003
1A2	1. Energy A. Fuel Comb. 2. Manuf. Ind. and Constr. Gaseous Fuels	CH4	0.04	0.02	5.0	29.58	30.0	0.003
6A	6. Waste A. Solid Waste Disposal on Land	CH4	0.22	0.01	42.4	42.43	60.0	0.003
1A4a	1. Energy A. Fuel Comb. 4. Commercial/Institutional Biomass	CH4	0.00	0.02	20.0	22.36	30.0	0.002
1A2	1. Energy A. Fuel Comb. 2. Manuf. Ind. and Constr. Gaseous Fuels	N2O	0.01	0.01	5.0	79.84	80.0	0.002
6C	6. Waste C. Waste Incineration	CH4	0.01	0.01	42.4	42.43	60.0	0.001
2F	2. Ind. Proc. F. Consumption of Halocarbons and SF6	SF6	0.00	0.01	14.1	14.14	20.0	0.001
1A3b	1. Energy A. Fuel Comb. 3. Road Transportation Biomass	N2O	0.00	0.00	20.0	148.66	150.0	0.001
1A4a	1. Energy A. Fuel Comb. 4. Commercial/Institutional Liquid Fuels	CH4	0.02	0.01	20.0	22.36	30.0	0.001
1A3a	1. Energy A. Fuel Comb. 3. Civil Aviation	N2O	0.00	0.00	15.0	149.25	150.0	0.001
1A3b	1. Energy A. Fuel Comb. 3. Road Transportation Diesel	CH4	0.01	0.00	15.0	58.09	60.0	0.001
1A1	1. Energy A. Fuel Comb. 1. Energy Industries Gaseous Fuels	N2O	0.00	0.00	5.0	79.84	80.0	0.001

Table 1-7 continued

IPCC GPG Table 6.1
Tier 1 Uncertainty Calculation and Reporting

A	B	C	D	E	F	G	H	I	J	K	L	M
IPCC Source category	Gas	Base year emissions 1990	Year 2011 emissions	Activity data unc.	Emission factor unc.	Combined unc.	Combined unc. as % of total national emission in year t	Type A sensitivity	Type B sensitivity	Unc. in trend in national emissions introduced by emission factor unc.	Unc. in trend in national emissions introduced by activity data unc.	Unc. introduced into the trend in total national emissions
	Input data	Input data	Input data	Input data	Input data	Calc/Input	%	%	%	%	%	%
	Gg CO2 eq	Gg CO2 eq	%	%	%	%	%	%	%	%	%	%
Total Uncertainty including LULUCF	260.85	254.93					5.28					5.19
2C 2. Ind. Proc. C. Metal Production	CH4	0.00	0.00	0.0	0.00	0.0	0.00	0.00	0.00	0.00	0.00	0.00
2C 2. Ind. Proc. C. Metal Production	CO2	0.00	0.00	0.0	0.00	0.0	0.00	0.00	0.00	0.00	0.00	0.00
2C 2. Ind. Proc. C. Metal Production	N2O	0.00	0.00	0.0	0.00	0.0	0.00	0.00	0.00	0.00	0.00	0.00
2D 2. Ind. Proc. D. Other Production	CO2	0.00	0.00	0.0	0.00	0.0	0.00	0.00	0.00	0.00	0.00	0.00
2E 2. Ind. Proc. E. Prod. of Halocarbons and SF6	CO2	0.00	0.00	0.0	0.00	0.0	0.00	0.00	0.00	0.00	0.00	0.00
2F 2. Ind. Proc. F. Cons. of Halocarbons and SF6	CO2	0.00	0.00	0.0	0.00	0.0	0.00	0.00	0.00	0.00	0.00	0.00
2F 2. Ind. Proc. F. Cons. of Halocarbons and SF6	HFC	0.00	8.73	11.3	11.31	16.0	0.55	0.03	0.03	0.38	0.54	0.66
2F 2. Ind. Proc. F. Cons. of Halocarbons and SF6	PFC	0.00	0.07	14.1	14.14	20.0	0.01	0.00	0.00	0.00	0.01	0.01
2F 2. Ind. Proc. F. Cons. of Halocarbons and SF6	SF6	0.00	0.01	14.1	14.14	20.0	0.00	0.00	0.00	0.00	0.00	0.00
2G 2. Ind. Proc. G. Other	CH4	0.00	0.00	0.0	0.00	0.0	0.00	0.00	0.00	0.00	0.00	0.00
2G 2. Ind. Proc. G. Other	CO2	0.00	0.00	0.0	0.00	0.0	0.00	0.00	0.00	0.00	0.00	0.00
2G 2. Ind. Proc. G. Other	N2O	0.00	0.00	0.0	0.00	0.0	0.00	0.00	0.00	0.00	0.00	0.00
3 3. Solvent and Other Product Use	CO2	1.55	0.73	56.6	56.57	80.0	0.23	0.00	0.00	-0.17	0.22	0.28
3 3. Solvent and Other Product Use	N2O	0.47	0.27	56.6	56.57	80.0	0.08	0.00	0.00	-0.04	0.08	0.09
4A 4. Agriculture A. Enteric Fermentation	CH4	10.42	10.72	6.4	17.20	18.4	0.77	0.00	0.04	0.04	0.37	0.37
4B 4. Agriculture B. Manure Mgmt	CH4	2.16	2.02	6.4	54.10	54.5	0.43	0.00	0.01	-0.02	0.07	0.07
4B 4. Agriculture B. Manure Mgmt	N2O	1.21	1.38	44.4	44.41	62.8	0.34	0.00	0.01	0.03	0.33	0.33
4C 4. Agriculture C. Rice Cultivation	CH4	0.00	0.00	0.0	0.00	0.0	0.00	0.00	0.00	0.00	0.00	0.00
4D 4. Agriculture D. Agr. Soils	CH4	0.00	0.00	0.0	0.00	0.0	0.00	0.00	0.00	0.00	0.00	0.00
4D 4. Agriculture D. Agr. Soils wo 4D1-N2O & 4D3-N2O	N2O	0.99	1.10	60.2	60.22	85.2	0.37	0.00	0.00	0.03	0.36	0.36
4D1 4. Agriculture D. Agr. Soils; Direct Soil Emissions	N2O	5.45	5.56	20.4	69.00	71.9	1.57	0.00	0.02	0.06	0.61	0.62
4D3 4. Agriculture D. Agr. Soils; Indirect Emissions	N2O	2.72	2.59	31.8	154.00	157.2	1.60	0.00	0.01	-0.04	0.45	0.45
4E 4. Agriculture E. Prescribed Burning of Savannas	CH4	0.00	0.00	0.0	0.00	0.0	0.00	0.00	0.00	0.00	0.00	0.00
4E 4. Agriculture E. Prescribed Burning of Savannas	N2O	0.00	0.00	0.0	0.00	0.0	0.00	0.00	0.00	0.00	0.00	0.00
4F 4. Agriculture F. Field Burning of Agr. Residues	CH4	0.00	0.00	0.0	0.00	0.0	0.00	0.00	0.00	0.00	0.00	0.00
4F 4. Agriculture F. Field Burning of Agr. Residues	N2O	0.00	0.00	0.0	0.00	0.0	0.00	0.00	0.00	0.00	0.00	0.00
4G 4. Agriculture G. Other	CH4	0.00	0.00	0.0	0.00	0.0	0.00	0.00	0.00	0.00	0.00	0.00
4G 4. Agriculture G. Other	N2O	0.00	0.00	0.0	0.00	0.0	0.00	0.00	0.00	0.00	0.00	0.00
6A 6. Waste A. Solid Waste Disposal on Land	CH4	0.22	0.01	42.4	42.43	60.0	0.00	0.00	0.00	-0.03	0.00	0.03
6A 6. Waste A. Solid Waste Disposal on Land	CO2	0.00	0.00	0.0	0.00	0.0	0.00	0.00	0.00	0.00	0.00	0.00
6B 6. Waste B. Wastewater Handling	CH4	0.05	0.07	42.4	42.43	60.0	0.02	0.00	0.00	0.00	0.02	0.02
6B 6. Waste B. Wastewater Handling	N2O	0.79	0.97	106.1	106.07	150.0	0.57	0.00	0.00	0.08	0.56	0.56
6C 6. Waste C. Waste Incineration	CH4	0.01	0.01	42.4	42.43	60.0	0.00	0.00	0.00	0.00	0.00	0.00
6C 6. Waste C. Waste Incineration	CO2	0.03	0.03	28.3	28.28	40.0	0.01	0.00	0.00	0.00	0.01	0.01
6C 6. Waste C. Waste Incineration	N2O	0.00	0.00	106.1	106.07	150.0	0.00	0.00	0.00	0.00	0.00	0.00
6D 6. Waste D. Other	CH4	0.40	0.58	42.4	42.43	60.0	0.14	0.00	0.00	0.03	0.13	0.14
6D 6. Waste D. Other	CO2	0.00	0.00	0.0	0.00	0.0	0.00	0.00	0.00	0.00	0.00	0.00
6D 6. Waste D. Other	N2O	0.08	0.12	106.1	106.07	150.0	0.07	0.00	0.00	0.02	0.07	0.07
Emissions LULUCF												
5A1 5. LULUCF A. Forest Land 1. FL remaining FL	CH4	0.00	0.00	10.0	70.00	70.7	0.00	0.00	0.00	0.00	0.00	0.00
5A1 5. LULUCF A. Forest Land 1. FL remaining FL	CO2	17.89	18.34	5.0	36.00	36.3	2.61	0.00	0.07	0.12	0.50	0.51
5A1 5. LULUCF A. Forest Land 1. FL remaining FL	N2O	0.00	0.00	10.0	70.00	70.7	0.00	0.00	0.00	0.00	0.00	0.00
5A2 5. LULUCF A. Forest Land 2. Land conv. to FL	CO2	2.10	1.62	20.0	36.00	41.2	0.26	0.00	0.01	-0.06	0.18	0.19
5B1 5. LULUCF B. Cropland 1. Cropland remaining Cropland	CO2	4.10	4.37	30.0	25.00	39.1	0.67	0.00	0.02	0.04	0.71	0.71
5B2 5. LULUCF B. Cropland 2. Land conv. d to Cropland	CO2	0.34	0.22	20.0	50.00	53.9	0.05	0.00	0.00	-0.02	0.02	0.03
5B2 5. LULUCF B. Cropland 2. Land conv. to Cropland	N2O	0.01	0.01	6.0	90.00	90.2	0.01	0.00	0.00	0.00	0.00	0.00
5C1 5. LULUCF C. Grassland 1. Grassland remaining G.	CO2	1.60	1.13	20.0	50.00	53.9	0.24	0.00	0.00	-0.08	0.12	0.15
5C2 5. LULUCF C. Grassland 2. Land conv. d to Grassland	CO2	0.30	2.05	20.0	50.00	53.9	0.43	0.01	0.01	0.34	0.22	0.40
5D1 5. LULUCF D. Wetlands 1. Wetlands remaining W.	CO2	0.00	0.00	25.0	50.00	55.9	0.00	0.00	0.00	0.00	0.00	0.00
5D2 5. LULUCF D. Wetlands 2. Land conv. to Wetlands	CO2	0.16	0.22	25.0	50.00	55.9	0.05	0.00	0.00	0.01	0.03	0.03
5E1 5. LULUCF E. Settlements 1. Settlements remaining S	CO2	0.28	0.29	20.0	50.00	53.9	0.06	0.00	0.00	0.00	0.03	0.03
5E2 5. LULUCF E. Settlements 2. Land conv. to Settlements	CO2	3.30	3.48	20.0	50.00	53.9	0.73	0.00	0.01	0.05	0.38	0.38
5F2 5. LULUCF F. Other Land 2. Land conv. to Other Land	CO2	0.44	1.15	20.0	50.00	53.9	0.24	0.00	0.00	0.14	0.12	0.19

Table 1-8 Further information on the Tier 1 uncertainty calculation and reporting for sources in Liechtenstein, 2011 (continued).

Table 6.1 (CONTINUED)
Tier 1 Uncertainty Calculation and Reporting

A (continued)				B	N	O	P	Q
IPCC Source category				Gas	Emission factor quality indicator	Activity data quality indicator	Expert judgement reference numbers	Reference to section in NIR
					Note E IPCC Default, Measurement based, national Referenced data	Note E IPCC Default, Measurement based, national Referenced data		
1A	1. Energy	A. Fuel Combustion	Gaseous fuels	CO2	M	D		Section 3.2.6
1A	1. Energy	A. Fuel Combustion	Gas oil and LPG	CO2	M	R		Section 3.2.6
1A	1. Energy	A. Fuel Combustion	Gasoline	CO2	M	R		Section 3.2.6
1A	1. Energy	A. Fuel Combustion	Diesel	CO2	M	R		Section 3.2.6
1A	1. Energy	A. Fuel Combustion	Jet Kerosene	CO2	M	R		Section 3.2.6
1A	1. Energy	A. Fuel Combustion	Solid fuels	CO2	D	D, R		Section 3.2.6
2F	2. Industrial Proc.	F. Consumption of Halocarbons and SF6		HFC	R	R		Section 4.7.3
4A	4. Agriculture	A. Enteric Fermentation		CH4	R	R		Section 6.2.3
4D1	4. Agriculture	D. Agricultural Soils; Direct Soil Emissions		N2O	D	R		Section 6.5.3
4D3	4. Agriculture	D. Agricultural Soils; Indirect Emissions		N2O	D	D		Section 6.5.3
5A1	5. LULUCF	A. Forest Land	1. Forest Land remaining Forest Land	CO2	R	R		Section 7.3.3
5B1	5. LULUCF	B. Cropland	1. Cropland remaining Cropland	CO2	R	R		Section 7.4.3
5C1	5. LULUCF	C. Grassland	1. Grassland remaining Grassland	CO2	R	R		Section 7.5.3
5C2	5. LULUCF	C. Grassland	2. Land converted to Grassland	CO2	R	R		Section 7.5.3
5D2	5. LULUCF	D. Wetlands	2. Land converted to Wetlands	CO2	R	R		Section 7.6.3
5E2	5. LULUCF	E. Settlements	2. Land converted to Settlements	CO2	R	R		Section 7.7.3
Rest of sources				All	R	R		Exp. est.

1.7.1.4 Results of Tier 2 Uncertainty Evaluation (Monte Carlo)

A Tier 2 uncertainty analysis for Liechtenstein's GHG Inventory was carried out for the inventory submitted in 2009 (OEP 2009a) and contained a level uncertainty for 2007 and a trend uncertainty for the period 1990-2007. **For the inventory year 2011 (i.e. the current submission) the Monte Carlo simulation has not been updated.** This analysis will be conducted again for the submission 2014.

The main results for 2007 (must not be compared with the Tier 1 results for 2010 above) were

- The total uncertainty level of the 2007 Liechtenstein emissions is **6,05%** of the total GHG emissions excluding LULUCF. The 95% confidence interval is almost symmetric and lies between **94.0% and 106.1%** of the total GHG emissions.
- The change in total emissions between 1990 and 2007 is +6.1%. With a probability of 95%, the change lies within the range of **-2.7% to +15.0%, corresponding to a trend uncertainty of 8.9%**.
- Assumptions and further results of Monte Carlo simulation are shown in Annex 7)

1.7.1.5 Comparison of Tier 1 and Tier 2 Results

Since no Tier 2 analysis was carried out for the GHG inventory 2011, there is no comparison for the number 2011. Note that a comparison was carried out for the GHG inventory 2007. The results of the comparison are described in Annex A7.2.

1.7.2 KP-LULUCF Inventory

The uncertainty of Afforestation is 21.9% while the uncertainty of Deforestation is 32.5%. Combined level uncertainty of the total KP-LULUCF Inventory is 63.5% (see Chapter 11.3.1.5 for details of the calculation). Thus, with a probability of 95%, the KP-LULUCF sink is $0.21 \text{ Gg CO}_2 \pm 0.13 \text{ Gg CO}_2$.

1.8 *Completeness Assessment*

1.8.1 GHG Inventory

Liechtenstein's current GHG inventory is complete for all Kyoto gases.

1.8.2 KP-LULUCF Inventory

Liechtenstein's current KP-LULUCF Inventory is complete.

2 Trends in Greenhouse Gas Emissions and Removals

This chapter gives an overview of Liechtenstein's GHG emissions and removals as well as their trends in the period 1990–2011.

2.1 Aggregated Greenhouse Gas Emissions 2011

In 2011, Liechtenstein emitted 222.0 Gg (kilotonnes) CO₂ equivalent, or 6.1 tonnes CO₂ equivalent per capita (CO₂ only: 5.1 tonnes per capita) to the atmosphere excluding emissions and removals from Land Use, Land-Use Change and Forestry (LULUCF). At the beginning of the Kyoto compliance period in 2006 per capita emissions were as high as 8 tonnes per capita and since then continuously declined by 23%. The largest contributor gas is CO₂, and the most important sources of emissions are fuel combustion activities in the Energy sector. Table 2-1 shows the emissions for individual gases and sectors in Liechtenstein for the year 2011. Emissions of CH₄ and N₂O originated mainly from the sector Agriculture, and the synthetic gas emissions originated by definition from the sector Industrial Processes.

Table 2-1 Summary of Liechtenstein's GHG emissions by gas and sector in CO₂ equivalent (Gg), 2011. (Numbers may not add to totals due to rounding.)

Emissions 2011	CO ₂	CH ₄	N ₂ O	HFCs	PFCs	SF ₆	Total
	CO ₂ equivalent (Gg)						
1 Energy	184.0	2.0	1.0				187.1
2 Industrial Processes	NO	NO	NO	8.7	0.1	0.0	8.8
3 Solvent and other Product Use	0.7		0.3				1.0
4 Agriculture		12.7	10.6				23.4
6 Waste	0.0	0.7	1.1				1.8
Total (excluding LULUCF)	184.8	15.4	13.0	8.7	0.1	0.0	222.0
5 LULUCF	-7.0	NO	0.0				-7.0
Total (including LULUCF)	177.8	15.4	13.0	8.7	0.1	0.0	215.0
<i>International Bunkers</i>	<i>0.8</i>	<i>0.0</i>	<i>0.0</i>				<i>0.8</i>

A breakdown of Liechtenstein's total emissions by gas is shown in Figure 2-1 below. Figure 2-2 is a bar chart of contributions to GHG emissions by gas and sector.

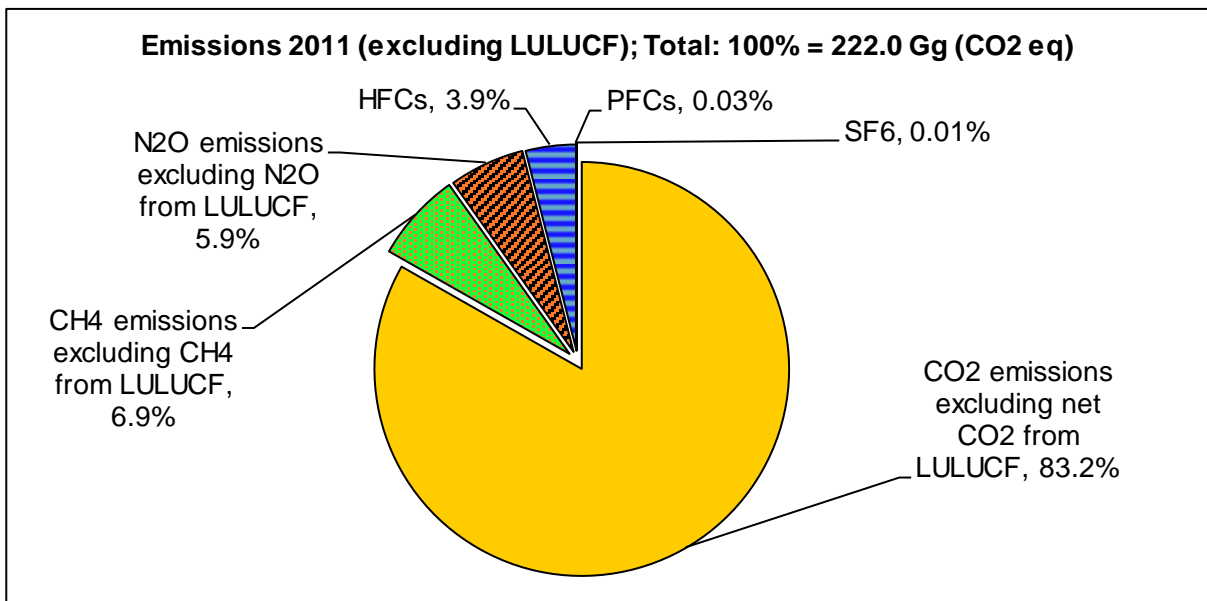

Figure 2-1 Liechtenstein's GHG emissions by gas excluding LULUCF in 2011.

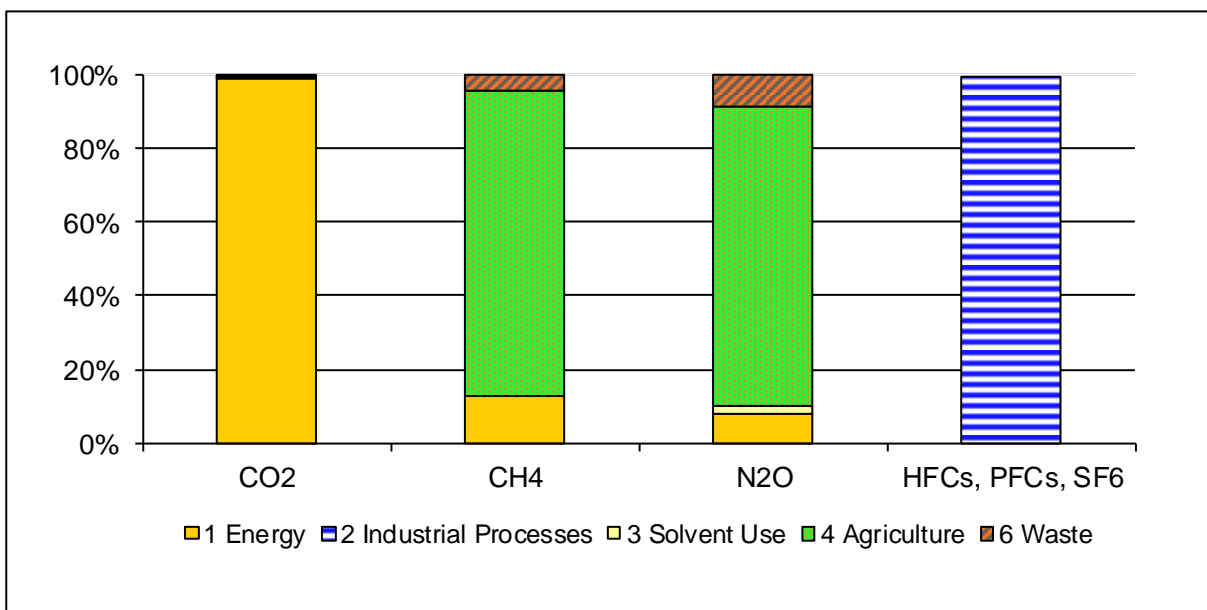

Figure 2-2 Relative contributions of the individual sectors (excluding LULUCF) to GHG emissions in 2011.

2.2 Emission Trends by Gas

Emission trends 1990–2011 by gas are summarised in Table 2-2 and in Figure 2-3..

Table 2-2 Summary of Liechtenstein's GHG emissions in CO₂ equivalent (Gg) by gas, 1990–2011. The last column shows the percentage change in emissions in 2011 as compared to the base year 1990.

Greenhouse Gas Emissions	1990	1991	1992	1993	1994	1995	1996	1997	1998	1999
	CO ₂ equivalent (Gg)									
CO ₂ emissions including net CO ₂ from LULUCF	193.6	201.3	202.2	210.4	196.5	199.8	201.9	214.5	226.1	225.5
CO ₂ emissions excluding net CO ₂ from LULUCF	203.1	210.8	211.7	220.0	206.1	209.4	211.6	223.9	235.2	234.3
CH ₄ emissions including CH ₄ from LULUCF	14.4	14.2	14.0	13.3	13.5	13.4	13.8	13.5	13.5	13.1
CH ₄ emissions excluding CH ₄ from LULUCF	14.4	14.2	14.0	13.3	13.5	13.4	13.8	13.5	13.5	13.1
N ₂ O emissions including N ₂ O from LULUCF	12.9	13.2	13.1	12.7	12.6	12.5	12.5	12.4	12.3	12.1
N ₂ O emissions excluding N ₂ O from LULUCF	12.9	13.2	13.1	12.7	12.6	12.5	12.5	12.4	12.3	12.1
HFCs	0.0	0.0	0.0	0.1	0.1	0.4	0.7	1.0	1.4	1.8
PFCs	NA,NO	NA,NO	NA,NO	NA,NO	NA,NO	NA,NO	NA,NO	NA,NO	0.0	0.0
SF ₆	NA,NO	NA,NO	NA,NO	NA,NO	NA,NO	NA,NO	0.0	0.0	0.0	0.0
Total (including LULUCF)	220.9	228.8	229.2	236.5	222.7	226.1	228.9	241.5	253.2	252.5
Total (excluding LULUCF)	230.3	238.3	238.8	246.1	232.3	235.7	238.6	250.9	262.4	261.3

Greenhouse Gas Emissions	2000	2001	2002	2003	2004	2005	2006	2007	2008	2009
	CO ₂ equivalent (Gg)									
CO ₂ emissions including net CO ₂ from LULUCF	219.0	217.3	222.5	232.1	232.3	232.2	234.0	203.4	222.5	206.9
CO ₂ emissions excluding net CO ₂ from LULUCF	227.6	225.6	230.6	240.0	240.2	239.9	241.6	210.9	229.9	214.2
CH ₄ emissions including CH ₄ from LULUCF	13.0	13.6	13.9	14.0	14.1	14.6	15.2	15.5	15.8	15.5
CH ₄ emissions excluding CH ₄ from LULUCF	13.0	13.6	13.9	14.0	14.1	14.6	15.2	15.5	15.8	15.5
N ₂ O emissions including N ₂ O from LULUCF	12.0	12.3	12.3	12.4	12.4	12.6	12.8	12.9	13.0	12.8
N ₂ O emissions excluding N ₂ O from LULUCF	12.0	12.3	12.3	12.4	12.4	12.6	12.8	12.9	13.0	12.8
HFCs	2.3	3.0	3.3	3.8	4.3	4.4	4.4	4.7	5.1	5.3
PFCs	0.0	0.0	0.0	0.0	0.0	0.0	0.0	0.1	0.1	0.1
SF ₆	0.1	0.2	0.3	0.3	0.3	0.3	0.1	0.1	0.4	0.1
Total (including LULUCF)	246.3	246.4	252.2	262.5	263.5	264.1	266.4	236.7	256.8	240.8
Total (excluding LULUCF)	254.9	254.7	260.3	270.5	271.3	271.8	274.0	244.2	264.2	248.0

Greenhouse Gas Emissions	2010	2011	1990-2011
	CO ₂ equivalent (Gg)		%
CO ₂ emissions including net CO ₂ from LULUCF	192.4	177.8	-8.2
CO ₂ emissions excluding net CO ₂ from LULUCF	199.6	184.8	-9.0
CH ₄ emissions including CH ₄ from LULUCF	15.1	15.4	7.2
CH ₄ emissions excluding CH ₄ from LULUCF	15.1	15.4	7.2
N ₂ O emissions including N ₂ O from LULUCF	12.7	13.0	1.3
N ₂ O emissions excluding N ₂ O from LULUCF	12.7	13.0	1.2
HFCs	6.7	8.7	---
PFCs	0.1	0.1	---
SF ₆	0.0	0.0	---
Total (including LULUCF)	227.0	215.0	-2.7
Total (excluding LULUCF)	234.1	222.0	-3.6

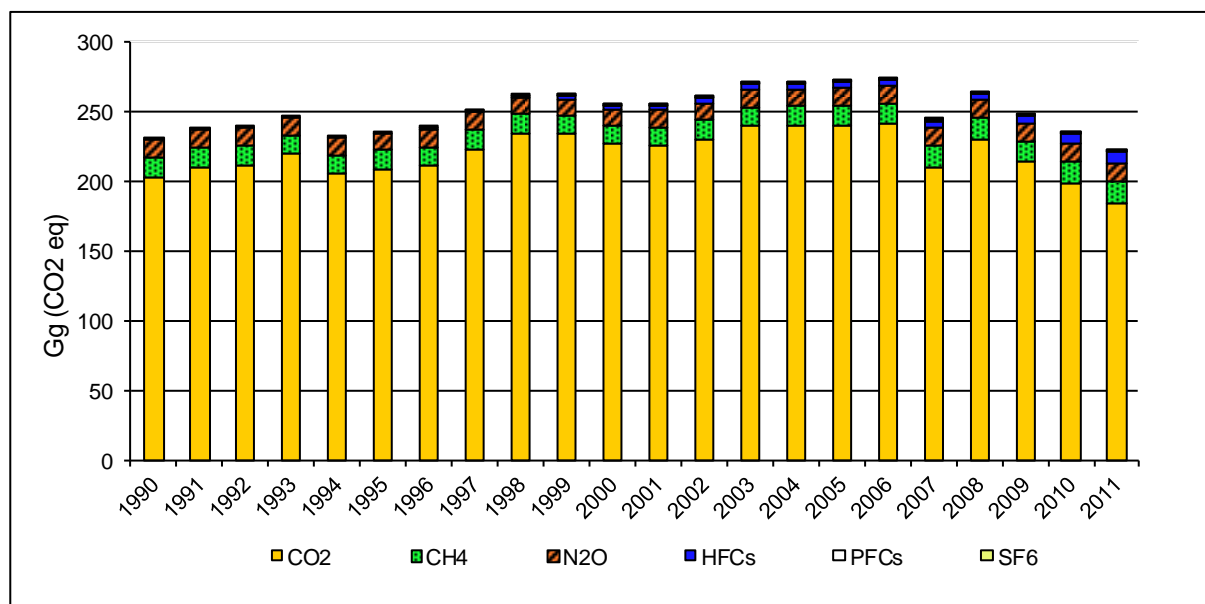

Figure 2-3 Trend of Liechtenstein's greenhouse gas emissions by gases 1990–2011. CO₂, CH₄ and N₂O correspond to the respective total emissions excluding LULUCF.

Emission trends for the individual gases are as listed:

- Total emissions excluding LULUCF Removals/Emissions decreased from 1990 to 2011 by 3.6%.
- Total emissions including LULUCF decreased by 2.7% compared to 1990 levels.
- CO₂ emissions excluding net CO₂ emissions from LULUCF decreased from 1990 to 2011 by 9.0%. CO₂ emissions contribute to the largest share of emissions, accounting for about 83.2% of the total emissions in 2011. This is the smallest share since 1990 which fluctuated between 83.2% and 89.7% in the period 1990–2011.
- CO₂ emissions excluding net CO₂ emissions from LULUCF indicate a decrease between 2010 and 2011 of 7.4%. Besides the increase of emissions in 2006 and 2008, caused by fuel price fluctuations, which resulted in changing stocking behaviour for fuel tanks, a continuous negative trend in CO₂ emissions can be observed since 2008.
- CH₄ emissions excluding CH₄ from LULUCF increased by 1.9% in comparison to 2010. However, compared to the 1990 emissions, an increase of 7.2% occurred. CH₄ emissions contribute to total national emissions of 6.9% in 2011, which is slightly higher than in 1990, where the share was 6.2%.
- Compared to 2010 N₂O emissions excluding N₂O from LULUCF have increased by 2% and by 1.2% when compared to 1990 levels. The contribution to the total national emissions increased from 5.6% in 1990 to 5.9% in 2011.
- HFC emissions (mainly from 2F1 Refrigeration and Air Conditioning Equipment) increased due to their role as substitutes for CFCs. SF₆ emissions originate from electrical transformation stations and play a minor role for the total of synthetic gases. PFC emissions are occurring since 1997 and are increasing on a low level. The share of synthetic gases increased from 0.0% (1990) to 3.9% (2011).

2.3 Emission Trends by Sources and Sinks

Table 2-3 shows emission trends for all major source and sink categories. As the largest share of emissions originated from the energy sector, the table also shows the contributions of the energy source categories (1A1-1A5, 1B).

Table 2-3 Summary of Liechtenstein's GHG emissions by source and sink categories in CO₂ equivalent (Gg), 1990–2011. The last column shows the percent change in emissions in 2011 compared to the base year 1990.

Source and Sink Categories	1990	1991	1992	1993	1994	1995	1996	1997	1998	1999
	CO ₂ equivalent (Gg)									
1 Energy	203.8	211.7	212.8	221.2	207.2	210.6	212.9	225.3	236.7	236.0
1A1 Energy Industries	0.2	0.8	1.9	1.9	1.8	2.0	2.5	2.5	2.9	2.9
1A2 Manufacturing Industries and Construction	35.3	34.2	34.2	36.0	34.2	34.4	34.3	35.9	38.2	37.6
1A3 Transport	76.7	90.0	89.2	87.0	79.6	81.5	82.8	86.4	86.1	91.8
1A4 Other Sectors	88.9	83.4	84.2	93.3	88.8	89.9	90.3	97.4	105.9	99.8
1A5 Other (Offroad)	2.4	2.9	3.0	2.4	2.3	2.2	2.3	2.6	3.0	3.1
1B Fugitive emissions from oil and natural gas	0.3	0.4	0.4	0.5	0.5	0.5	0.6	0.6	0.7	0.7
2 Industrial Processes	0.0	0.0	0.0	0.1	0.1	0.4	0.7	1.0	1.4	1.8
3 Solvent and Other Product Use	2.0	1.9	1.8	1.7	1.7	1.6	1.5	1.4	1.4	1.3
4 Agriculture	23.0	23.1	22.6	21.6	21.7	21.6	21.9	21.5	21.3	20.6
6 Waste	1.6	1.5	1.5	1.5	1.6	1.5	1.6	1.6	1.6	1.6
Total (excluding LULUCF)	230.3	238.3	238.8	246.1	232.3	235.7	238.6	250.9	262.4	261.3
5 Land Use, Land-Use Change and Forestry	-9.5	-9.5	-9.5	-9.6	-9.6	-9.6	-9.7	-9.4	-9.1	-8.9
Total (including LULUCF)	220.9	228.8	229.2	236.5	222.7	226.1	228.9	241.5	253.2	252.5

Source and Sink Categories	2000	2001	2002	2003	2004	2005	2006	2007	2008	2009
	CO ₂ equivalent (Gg)									
1 Energy	229.5	227.4	232.4	242.0	242.2	242.1	243.8	213.2	232.3	216.5
1A1 Energy Industries	2.7	2.9	2.5	2.8	2.9	3.1	2.8	2.5	2.9	2.9
1A2 Manufacturing Industries and Construction	34.3	34.6	35.7	38.3	37.4	36.2	37.4	30.9	33.0	23.8
1A3 Transport	95.8	92.2	87.7	87.3	86.1	85.6	82.6	86.7	91.1	85.0
1A4 Other Sectors	92.8	94.4	103.0	109.3	111.9	112.7	116.2	88.6	100.5	100.2
1A5 Other (Offroad)	3.0	2.6	2.8	3.5	3.1	3.5	3.7	3.4	3.6	3.7
1B Fugitive emissions from oil and natural gas	0.7	0.8	0.8	0.9	0.9	1.0	1.1	1.1	1.1	1.0
2 Industrial Processes	2.4	3.2	3.5	4.0	4.6	4.7	4.5	4.8	5.5	5.5
3 Solvent and Other Product Use	1.2	1.2	1.1	1.1	1.0	1.0	1.0	1.0	1.0	1.0
4 Agriculture	20.1	21.3	21.5	21.6	21.7	22.1	23.0	23.3	23.4	23.2
6 Waste	1.7	1.6	1.7	1.8	1.7	1.9	1.8	1.9	2.0	1.8
Total (excluding LULUCF)	254.9	254.7	260.3	270.5	271.3	271.8	274.0	244.2	264.2	248.0
5 Land Use, Land-Use Change and Forestry	-8.6	-8.3	-8.0	-7.9	-7.8	-7.7	-7.6	-7.5	-7.4	-7.2
Total (including LULUCF)	246.3	246.4	252.2	262.5	263.5	264.1	266.4	236.7	256.8	240.8

Source and Sink Categories	2010	2011	1990-2011
	CO ₂ equivalent (Gg)		%
1 Energy	201.9	187.1	-8.2
1A1 Energy Industries	3.2	3.0	1613.4
1A2 Manufacturing Industries and Construction	22.4	19.4	-45.2
1A3 Transport	80.5	79.5	3.7
1A4 Other Sectors	91.3	80.2	-9.8
1A5 Other (Offroad)	3.5	4.0	65.8
1B Fugitive emissions from oil and natural gas	1.1	1.0	223.1
2 Industrial Processes	6.7	8.8	---
3 Solvent and Other Product Use	1.0	1.0	-50.7
4 Agriculture	22.7	23.4	1.8
6 Waste	1.8	1.8	13.2
Total (excluding LULUCF)	234.1	222.0	-3.6
5 Land Use, Land-Use Change and Forestry	-7.1	-7.0	-25.7
Total (including LULUCF)	227.0	215.0	-2.7

Figure 2-4: Graphical representation of data. For the source category development of sector 1 Energy consult Chapter 3.

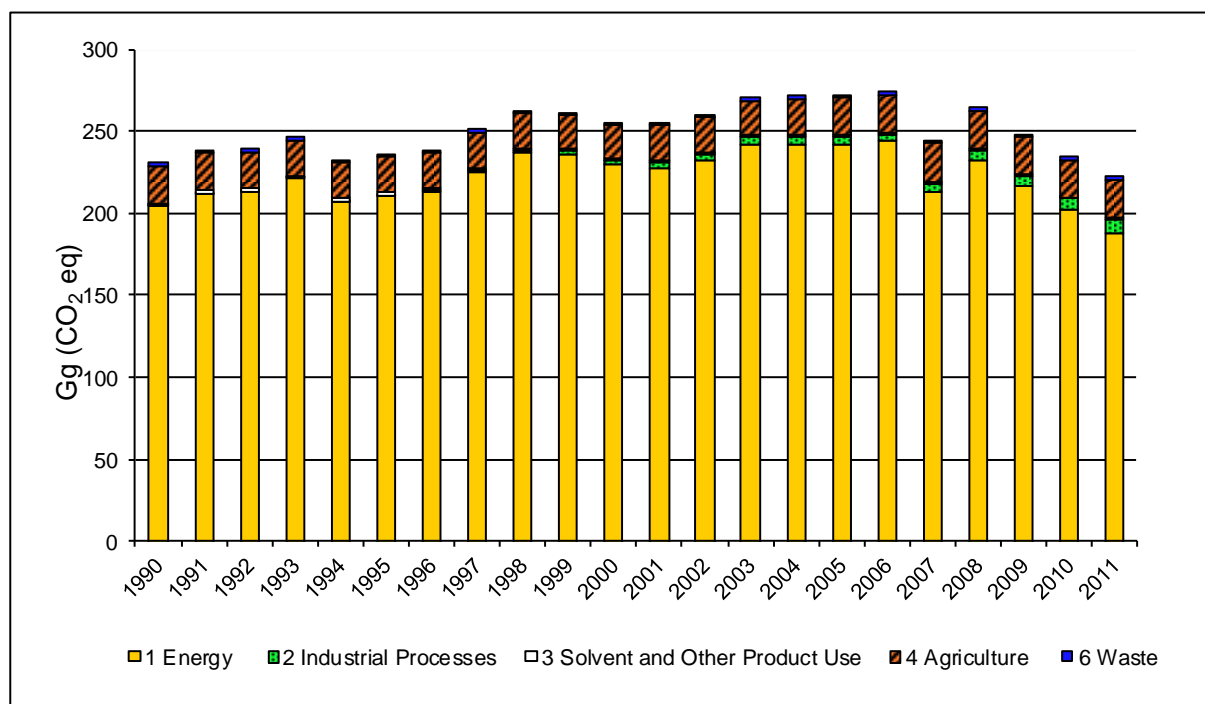

Figure 2-4 Trend of Liechtenstein's greenhouse gas emissions by main source categories in CO₂ equivalent (Gg), 1990–2011 (excl. net CO₂ from LULUCF).

The following emission trends in the sectors are found:

- 1 Energy: 84.3% (excluding LULUCF) of Liechtenstein's GHG emissions originate from the energy sector, which is 2.0% less than in 2010 and -8.2% in comparison to 1990. The source categories show following trends between 1990 and 2011:
- 1A1: Since 1990 Liechtenstein's gas-grid has been extended and natural gas has replaced gas oil as the main heating fuel in buildings.
- 1A2: Since 1990 the emissions from this source category have decreased by 45.19% in total. The consumption of gaseous fuels by industries decreased by 37.2% and the use of liquid fuels decreased even more (-52.2%). Compared to 2010 the gaseous fuels consumption decreased by 14.4%.
- 1A3: In line with a general increase of road-vehicle kilometres of all vehicle categories, the fuel consumption and emissions have increased since 1990 by 3.7%. However, there is a decrease in transport emissions of 1.17% in comparison to 2010.
- 1A4: The number of Inhabitants increased by 25.7% whereas employment has increased by 84.3% in the past 20 years. This is reflected in a similar increase of energy consumption and GHG emissions by 19.63% until 2006 with several fluctuations caused by warm and cold winter periods. From 2006 to 2007 a pronounced sudden decline of almost one forth is observed due to high oil gas prices and warm winters. Both influenced the stocking behaviours for private residential fuel tank holders and caused higher apparent consumption in 2008, when fuel tanks were refilled. Since 2008 GHG emissions in 1A4 have constantly decreased to 80.2 Gg CO₂ eq. in 2011. This negative trend can partly be attributed to the installation of a district heating pipeline, providing heat from the waste incineration plant in Switzerland, that was stepwise constructed in 2009 and 2010. Furthermore the various emission reduction measures in Liechtenstein, such as the increase of the CO₂-tax in 2010, might have resulted in a respective decrease. Also weather conditions have an important impact, as a

comparison of the heating degree days in the period 1990–2011 reveals: from 2000 up to 2009 the correlation between fuel combustion and winter climatic conditions was relatively high (coefficient of determination of 0.6). Although correlation drops to 0.48 in 2011, weather conditions were clearly relevant for the residential sector.

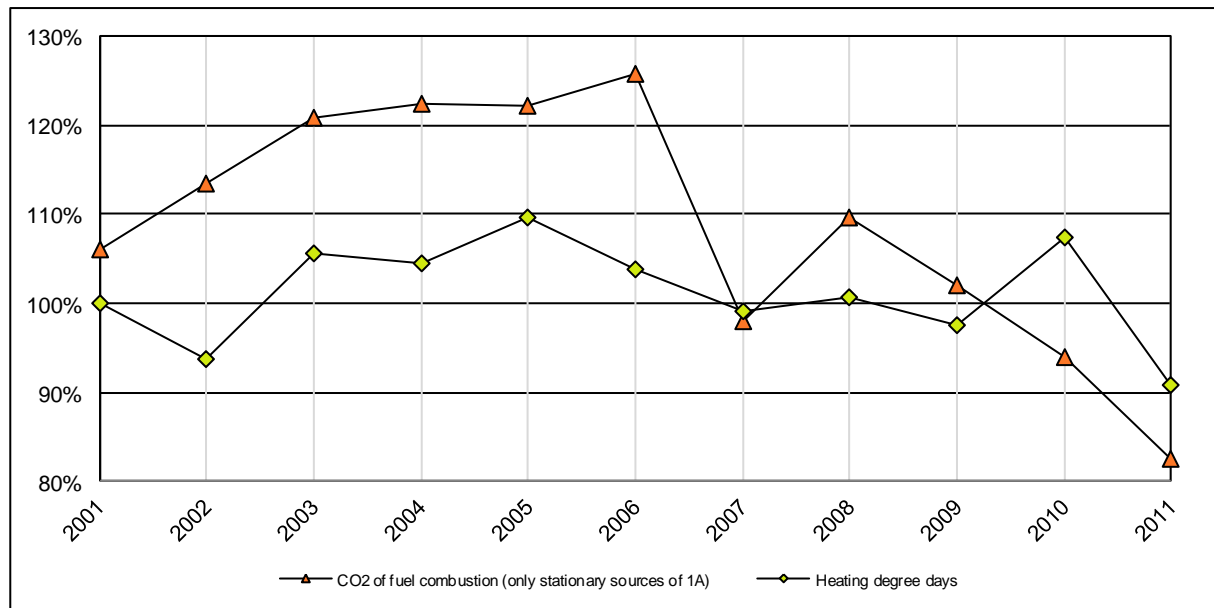

Figure 2-5 Relative trend for CO₂ emissions from 1A Fuel Combustion compared with the number of heating degree days. Drop in 2007 due to high oil gas prices and warm winters.

- 1A5: The emissions reported under this category are all kind of vehicles from construction sites. The general construction activities have increased in Liechtenstein with a subsequent, fluctuating increase of diesel consumption and emissions (65.8% within 1990-2011).
- 1B: In parallel with the built-up of Liechtenstein's gas supply network since 1990, the fugitive emissions have strongly increased over the period 1990-2011 (223.1%).
- 2: Industrial Processes: Due to the lack of heavy industry within the borders of the (small!) state of Liechtenstein, only synthetic gases contribute to sector 2.
- 3: Solvent and other product use: Emissions have decreased in the period 1990-2011 due to reduction measures for NMVOCs resulting from legal restrictions and the introduction of the VOC levy (-50.7%).
- 4: Agriculture: The emissions show a minimum around 2000 due to decreasing and increasing animal numbers. In 2011 the emissions are more or less on the same level as 1990 (increase of 1.8%).
- 5: LULUCF: Figure 2-6 shows the net removals (negative emissions) by sources and sinks from LULUCF categories in Liechtenstein. The dominant category when looking at the changes in net CO₂ removals are grassland and settlements. It can be observed that land-use conversions to grassland differ significantly between the three time periods 1990 to 1996, 1997 to 2002 and 2003 to 2011. In the period 1997 to 2002 a significant higher conversion from forest land to grassland leads to a reduction of net CO₂ removals. Other LULUCF categories than forest have a much smaller influence on the net removals.

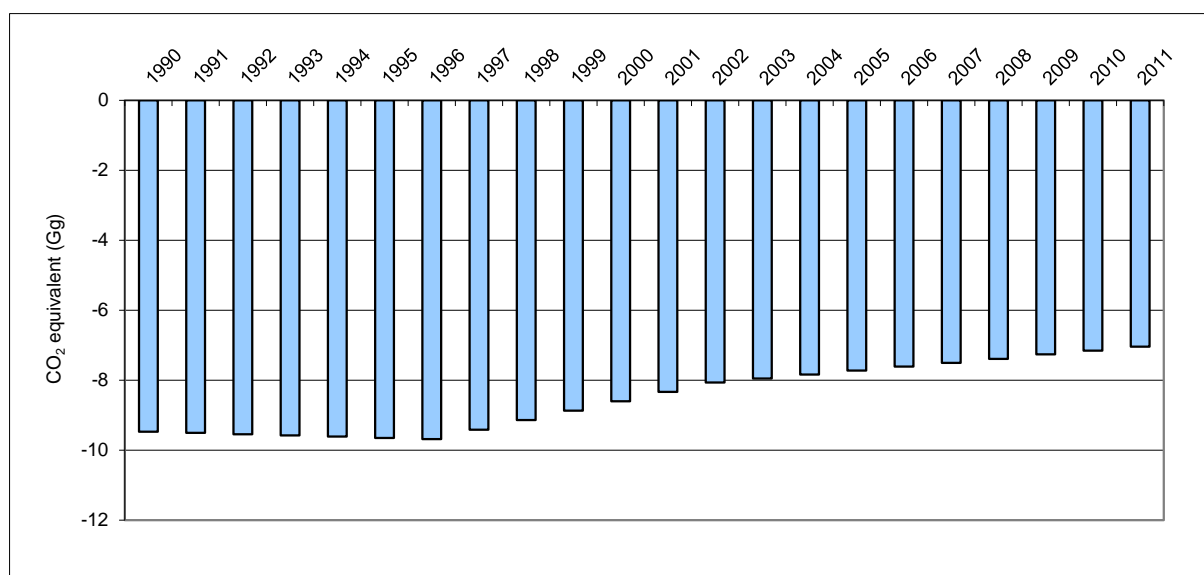

Figure 2-6 Net removals of CO₂ from LULUCF for 1990–2011.

- 6: Waste: In Liechtenstein only few emissions occur from the “Waste” sector, because all municipal solid waste is exported to a Swiss incineration plant. The increasing trend of the emissions compared to 1990 (13.16%) is determined by increasing composting activities and a slight increase in emissions from waste water handling.

2.4 Emission Trends for Indirect Greenhouse Gases and SO₂

Liechtenstein is member to the UNECE Convention on Long-range Transboundary Air Pollution (CLRTAP) and submits data on air pollutants including indirect GHG. For the precursor substances NO_x, CO and NMVOC as well as for the gas SO₂, data from the 2013 submission is shown in Table 2-4 (OE 2013). Note that the system boundaries for the transportation sector are not the same as under the UNFCCC Reporting since the CLRTAP uses the territorial principle, which restricts the comparability of the two data sets.

Table 2-4: Development of the emissions of NO_x, CO, NMVOC (in t) and SO_x 1990-2011.

Indirect Greenhouse Gasses and SO ₂	1990	1991	1992	1993	1994	1995	1996	1997	1998	1999
	t (Mg)									
NO _x	766	796	786	736	710	688	679	698	722	725
CO	2'231	2'138	1'959	1'773	1'638	1'481	1'349	1'240	1'139	1'035
NMVOC	990	986	881	822	700	675	562	550	543	533
SO _x	71	66	64	62	47	44	43	47	52	49

Indirect Greenhouse Gasses and SO ₂	2000	2001	2002	2003	2004	2005	2006	2007	2008	2009
	t (Mg)									
NO _x	706	658	665	711	670	696	694	658	657	656
CO	983	827	754	737	683	665	627	650	622	653
NMVOC	525	448	438	439	425	425	419	415	413	413
SO _x	42	38	41	43	36	36	38	27	32	35

Indirect Greenhouse Gasses and SO ₂	2010	2011	1990-2011 (%)
	t (Mg)		
NO _x	633	652	-15%
CO	657	676	-70%
NMVOC	410	414	-58%
SO _x	31	30	-58%

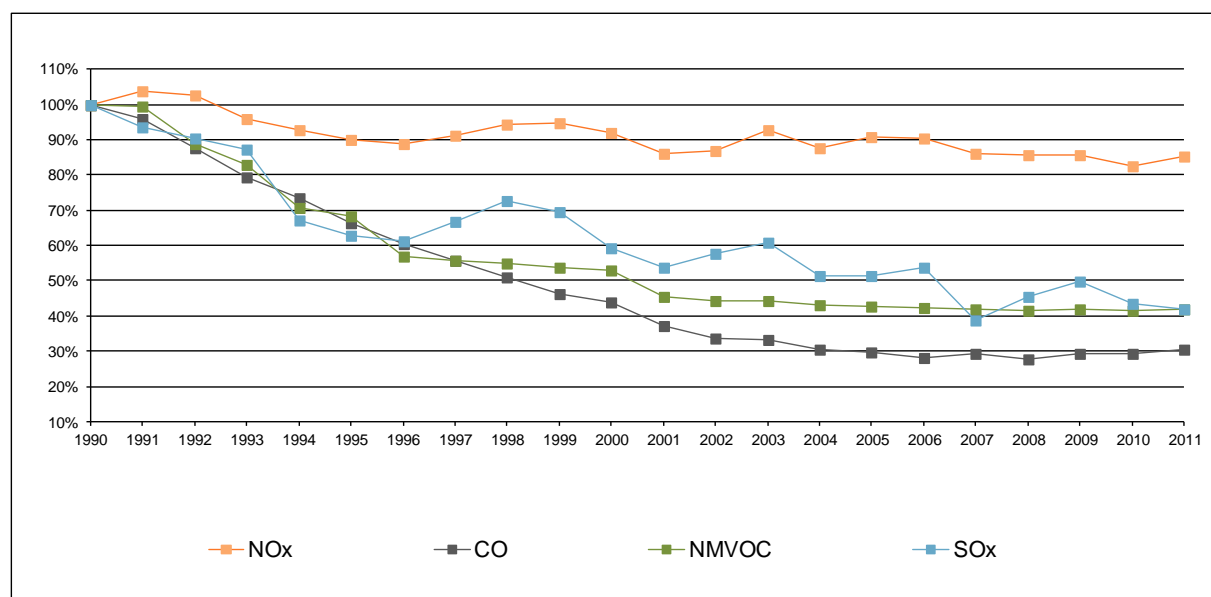
Figure 2-7 Trend of emissions of NO_x, CO, NMVOC and SO₂ 1990-2011.

The complete CLRTAP Inventory data may be found on the internet (see OE 2013)

2.5 *KP-LULUCF Inventory in Aggregate and by Activity, by Gas*

The afforested area of ca. 28 ha between 1990-2011 caused removals of 0.18 Gg CO₂ in 2011. Due to deforestation, 0.39 Gg CO₂ were emitted simultaneously in 2011. Afforestation and deforestation resulted in a net emission of 0.21 Gg CO₂ in 2011 (see Table 2-5).

Table 2-5: Summary table afforestation and deforestation. Numbers are taken from Table KP(5-l)A.1.1. and KP(5-l)A.2.

Activity	Area	Net CO ₂ emission/removal
	(cumulated 1990-2011) kha	2011 Gg CO ₂
Afforestation	0.03	-0.18
Deforestation	0.02	0.39
Total net CO₂ emission/removal		0.21

3 Energy

3.1 Overview

3.1.1 Greenhouse Gas Emissions

This chapter contains information about the greenhouse gas emissions of sector 1 / Energy. In Liechtenstein, the energy sector is the most relevant greenhouse gas source. In 2011, it emitted 187.1 Gg CO₂ equivalents which correspond to 84.4% of total emissions (221.54 Gg CO₂, without LULUCF). The emissions of the time period 1990–2011 are depicted in Figure 3-1.

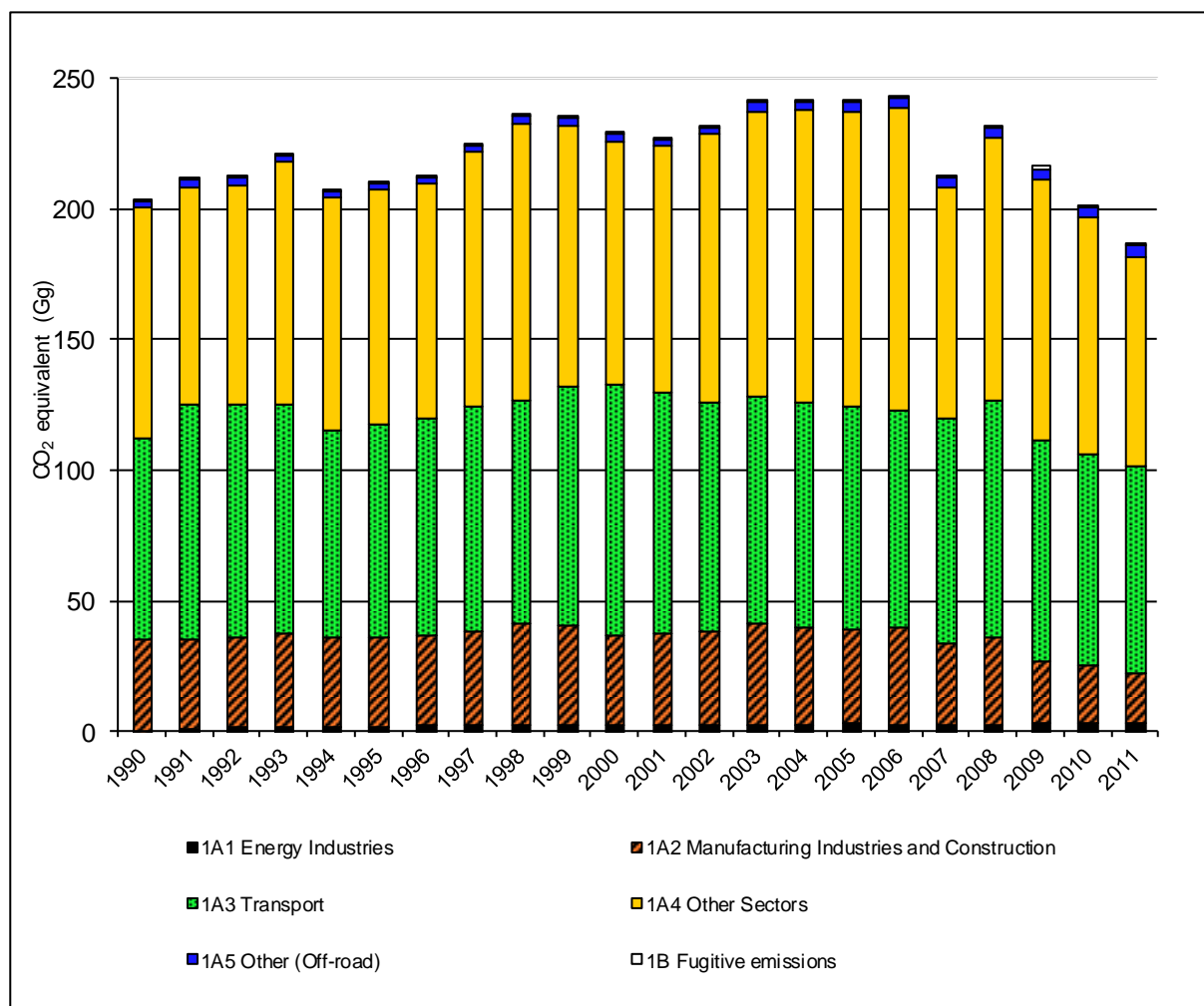

Figure 3-1 Liechtenstein's GHG emissions of the energy sector 1990–2011.

Table 3-1 summarises the emissions of the individual gases 1990–2011. It shows more details of the emissions of sector 1 Energy in 2011. The table includes emissions from international bunkers (aviation), as well as biomass which are both not accounted for in the Kyoto Protocol.

Table 3-1 GHG emissions of source category “1 Energy” in Liechtenstein by gas in CO₂ equivalent (Gg), 1990–2010 and the relative increase 1990–2011 (last column).

Gas	1990	1991	1992	1993	1994	1995	1996	1997	1998	1999
	CO ₂ equivalent (Gg)									
CO ₂	201.5	209.3	210.3	218.7	204.8	208.2	210.4	222.8	234.1	233.3
CH ₄	1.1	1.1	1.2	1.2	1.2	1.2	1.2	1.2	1.3	1.3
N ₂ O	1.1	1.2	1.3	1.3	1.2	1.2	1.2	1.3	1.3	1.3
Sum	203.8	211.7	212.8	221.2	207.2	210.6	212.9	225.3	236.7	236.0

Gas	2000	2001	2002	2003	2004	2005	2006	2007	2008	2009
	CO ₂ equivalent (Gg)									
CO ₂	226.5	224.7	229.6	239.1	239.4	239.1	240.8	210.1	229.1	213.4
CH ₄	1.5	1.4	1.5	1.6	1.6	1.7	1.8	1.9	1.9	1.9
N ₂ O	1.4	1.4	1.3	1.3	1.2	1.2	1.2	1.1	1.2	1.2
Sum	229.5	227.4	232.4	242.0	242.2	242.1	243.8	213.2	232.3	216.5

Gas	2010	2011	1990-2011
	CO ₂ equivalent (Gg)		%
CO ₂	198.8	184.0	-8.7
CH ₄	2.0	2.0	80.1
N ₂ O	1.1	1.0	-8.5
Sum	201.9	187.1	-8.2

Table 3-2 shows more details of the emissions of sector 1 Energy in 2011. The table includes emissions from international bunkers (aviation) as well as biomass which are both not accounted for in the Kyoto Protocol.

Table 3-2 Summary of sector energy, emissions in 2011 in Gg CO₂ equivalent (rounded values).

Emissions 2011 Sources	CO ₂	CH ₄	N ₂ O	Total	
	CO ₂ equivalent (Gg)			%	
1 Energy	184.0	1.99	1.05	187.1	100.0
1A Fuel Combustion	184.0	0.96	1.05	186.0	99.4
1A1 Energy Industries	2.9	0.03	0.08	3.0	1.6
1A2 Manufacturing Industries and Construction	19.3	0.03	0.03	19.4	10.4
1A3 Transport	78.8	0.16	0.60	79.5	42.5
1A4 Other Sectors	79.2	0.73	0.29	80.2	42.9
1A5 Other	3.9	0.00	0.05	4.0	2.1
1B Fugitive Emissions from Fuels	NA,NO	1.03	NA,NO	1.0	0.6
International Bunkers	0.8	0.00	0.00	0.8	NE,NO
CO₂ Emissions from Biomass	21.2	---	---	21.2	---

The most obvious features of the energy emissions may be characterised as follows:

- Concerning total emissions (CO₂ eq.) from the energy sector, a decrease of 8.2% in 2011 can be observed when compared to emissions in 1990. The first negative trend in total emissions from energy sector was observed in 2010 (-1.1% in comparison with 1990). Therefore this trend is ongoing and even more pronounced in 2011.
- The three source categories 1A2, 1A3 and 1A4 dominate the emissions of 1 Energy and cover together 95.7% of its emissions.
 - 1A2 Manufacturing Industries and Construction contribute 10.4% of the emissions.
 - 1A3 Transport is responsible for 42.5% of the emissions.
 - 1A4 Other Sectors (commercial/institutional, residential) is the largest source with 42.9% of the emissions.
 - 1A1 Energy Industries, 1A5 Other (Off-road) and 1B Fugitive Emissions only play a minor role. In 2011, they cover 1.6%, 2.1% 0.6%, respectively, of the total emissions of 1 Energy.
- The only occurring bunker emissions originate from a helicopter basis in Balzers, Liechtenstein. Only few flights are domestic, most of them are business flights to Switzerland and Austria, producing bunker emissions. The emissions are 0.8 Gg CO₂ eq.
- CO₂ emissions from biomass add up to 21.2 Gg. They include wood burning (heating) and the burning of gas from sewage treatment (heating, power).
- The far most important gas emitted from source category 1 Energy is CO₂. It accounts for 98.9% of the category in 1990 and for 98.4% in 2011.
- In 2011, CH₄ emissions contributed 1.03% to the total emissions of the energy sector. The increasing trend since 1990 (80.1%) is the result of the extended consumption of natural gas and the subsequent increase of fugitive emissions of methane (increase by a factor of 3.2). Additionally the CH₄ emissions of 1A4 have increased by a factor of 3.9 in the same period. The CH₄ emissions from road transportation have actually decreased by two thirds mainly due to the growing number of gasoline passenger cars with catalytic converters.
- N₂O contributed 0.56% (1990) and 0.52% (2011) to the total emissions of the energy sector. The changes in N₂O emissions may be explained by changes in the emission of passenger cars due to catalytic converters.

The Liechtenstein greenhouse gas inventory identifies 16 key sources (see Chapter 1.5), of which 11 belong to the energy sector. These are depicted in Figure 3-2. Most dominant are the CO₂ emissions from 1A3b Transport (gasoline).

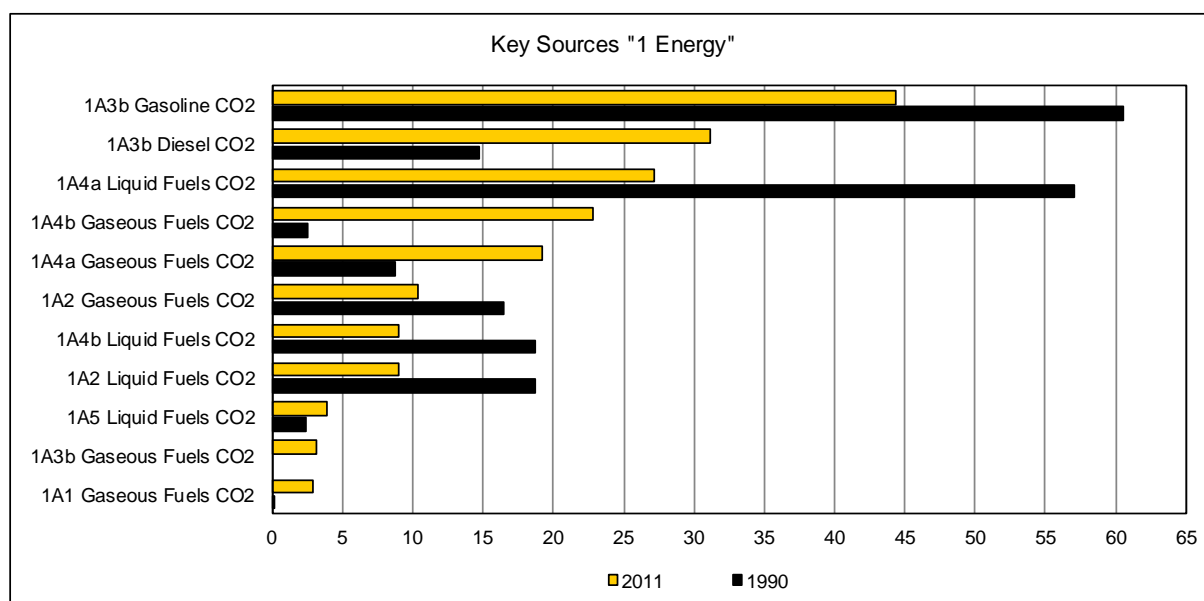

Figure 3-2 Key sources in the Liechtenstein GHG inventory pertaining to the energy sector.

3.1.2 CO₂ Emission Factors and Net Calorific Values

The CO₂ emission factors and the net calorific values (NCV) used for the calculation of the emissions of Sector 1 Energy are shown in Table 3-3.

Table 3-3 CO₂ emission factors and net calorific values (NCV) for fuels. The values are assumed to be constant over the period 1990-2011. The value for natural gas also holds for CNG (compressed natural gas) Data of the fossil fuels are based on SFOE (2001) confirmed by measurements (Intertek 2008). Biofuels data are based on EMIS 2012/ 1A3b.

Fuel	CO ₂ Emission Factor 1990-2011			Net calorific values (NCV)		Density t / volume
	t CO ₂ / TJ	t CO ₂ / t	t CO ₂ / volume	GJ / t	GJ / volume	
Hard Coal	94.0	2.47	---	26.3	---	---
Gas Oil	73.7	3.14	2.65t / 1000 lt	42.6	36.0 / 1000 lt	0.845 t / 1000 lt
Residual Fuel Oil	77.0	3.17	3.01t / 1000 lt	41.2	39.1 / 1000 lt	0.950 t / 1000 lt
Natural Gas	55.0	2.56	2.00t / 1000 Nm ³	46.5	36.3 / 1000 Nm ³	0.780 t / 1000 Nm ³
Gasoline	73.9	3.14	2.34t / 1000 lt	42.5	31.7 / 1000 lt	0.745 t / 1000 lt
Diesel Oil	73.6	3.15	2.61t / 1000 lt	42.8	35.5 / 1000 lt	0.830 t / 1000 lt
Propane/Butane (LPG)	65.5	---	---	46.0	---	---
Jet Kerosene	73.2	3.15	2.52t / 1000 lt	43.0	34.4 / 1000 lt	0.800 t / 1000 lt
Lignite	104.0	2.09	---	20.1	---	---
Alkylate Gasoline	73.9	3.14	2.34t / 1000 lt	42.5	31.7 / 1000 lt	0.745 t / 1000 lt
Biofuel (vegetable oil)	89.0	3.35	---	37.6	34.6 / 1000 lt	0.92 t / 1000 lt

The NCV are taken from Switzerland (SFOE 2001). An extended measurement campaign, commissioned by the Swiss FOEN and carried out by Intertek (2008) compared measured values with former measurements (EMPA 1999) and showed that the **assumption of constant NCV is widely fulfilled for fuels sold in Switzerland**. The authors write in their report, that only small deviations were found, which are hardly larger than the uncertainties of

the measurements¹. Note that the CO₂ emission factor for natural gas is confirmed by Liechtenstein's Gas utility LGV (2012).

3.1.3 Energy Statistics (Activity Data)

3.1.3.1 National Energy Statistics and Modifications

In general, the data is taken from Liechtenstein's energy statistics (OS 2012a). A more detailed analysis revealed that the data from the national energy statistics included some inconsistencies and could not simply be copied, but had to be revised in an adequate way as will be explained in the following sections. The revised data is summarised in Table 3-4.

¹ „Im Vergleich mit der letzten grösseren Heizwert-Untersuchung von 1998 (EMPA Prüfbericht Nr. 172853) können nur einige kleine Änderungen beobachtet werden, die aber kaum grösser als die Messungenauigkeit sind“ (Intertek 2008, p. 5). Translated freely into English: “Compared to the last analyses of NCV, only small differences may be observed, which are hardly larger than the uncertainty of the measurement.”

Table 3-4 Time series of Liechtenstein's fuel consumption due to the sales principle, including bunker fuel consumption (kerosene only) and biomass. Data sources: OS (2012a), OEP (2006c, 2008a, 2009a, 2010a, 2011a, 2012b), Rhein Helikopter (2006–2012).

Fuel	1990	1991	1992	1993	1994	1995	1996	1997	1998	1999
TJ										
Gasoline	819	916	957	947	878	903	910	954	896	940
Diesel	250	339	288	261	230	230	242	252	311	347
Gas Oil	1'272	1'116	1'077	1'189	1'095	1'065	988	1'125	1'208	1'060
Natural Gas	506	614	688	742	754	824	943	914	1'008	1'084
LPG	13.3	8.1	15.5	12.1	9.5	8.1	9.8	7.0	7.2	5.8
Hard Coal	0.97	0.92	1.10	1.00	0.71	0.68	0.50	0.53	0.55	0.29
Kerosene (domestic)	1.03	1.03	1.03	1.03	1.03	1.03	1.04	1.05	1.06	1.07
Sum	2'862	2'995	3'027	3'154	2'969	3'032	3'093	3'253	3'431	3'439
1990=100%	100%	105%	106%	110%	104%	106%	108%	114%	120%	120%
Kerosene (bunker)										
	5.84	5.84	5.84	5.84	5.84	5.84	6.00	6.16	6.33	6.49
Biomass										
Wood	44.7	30.9	44.6	40.5	51.1	37.7	35.0	42.5	47.5	52.2
Sewage gas	15.6	16.3	17.3	17.3	18.7	17.0	18.1	18.4	20.0	21.5
Biofuel	0.0	0.0	0.0	0.0	0.0	0.0	0.0	0.0	0.0	0.0
Sum biomass	60.2	47.2	61.8	57.7	69.8	54.7	53.1	60.9	67.5	73.7

Fuel	2000	2001	2002	2003	2004	2005	2006	2007	2008	2009
TJ										
Gasoline	1'040	1'007	920	880	852	823	753	757	761	700
Diesel	298	267	284	330	339	364	395	434	488	465
Gas Oil	931	885	1'001	1'061	1'030	986	1'026	608	777	873
Natural Gas	1'067	1'181	1'210	1'294	1'368	1'427	1'454	1'399	1'442	1'139
LPG	5.5	3.9	4.2	4.6	4.1	3.7	5.5	6.1	4.7	4.8
Hard Coal	0.63	0.34	0.32	0.34	0.26	0.24	0.16	0.13	0.11	0.05
Kerosene (domestic)	1.08	1.09	1.14	1.19	0.85	1.15	1.85	1.83	1.79	2.13
Sum	3'343	3'346	3'421	3'572	3'593	3'605	3'635	3'205	3'474	3'184
1990=100%	117%	117%	120%	125%	126%	126%	127%	112%	121%	111%
Kerosene (bunker)										
	6.66	6.82	6.12	6.74	4.82	6.52	10.47	10.36	10.14	12.08
Biomass										
Wood	91.5	56.0	58.6	77.4	84.7	93.8	107.1	142.7	144.0	176.1
Sewage gas	21.7	20.9	20.0	20.7	21.6	20.8	22.5	24.3	25.0	23.7
Biofuel	0.0	0.0	0.0	0.0	0.0	0.0	0.0	1.1	0.6	0.1
Sum biomass	113.2	76.9	78.6	98.2	106.3	114.6	129.6	168.1	169.6	199.9

Fuel	2010	2011
TJ		
Gasoline	632	601
Diesel	469	491
Gas Oil	695	608
Natural Gas	1'199	1'060
LPG	5.3	4.2
Hard Coal	0.05	0.05
Kerosene (domestic)	1.87	2.00
Sum	3'001	2'766
1990=100%	105%	97%
Kerosene (bunker)		
	10.59	11.34
Biomass		
Wood	189.5	206.0
Sewage gas	22.2	22.5
Biofuel	0.0	0.0
Sum biomass	211.7	228.5

The following modifications on the original energy statistics data have been carried out:

Gas oil: The consumption of gas oil in Liechtenstein's energy statistics reflects the amount of gas oil supplied annually to customers in Liechtenstein by oil transport companies. These customers include (i) final consumers as well as (ii) *Liechtenstein's main storage facility* for gas oil, located in Schaan. Gas oil supplied to final consumers in Liechtenstein stems both from sources in Switzerland as well as from Liechtenstein's storage. In order to avoid double counting, the amount of gas oil supplied to the storage facility has to be subtracted from the overall amount of gas oil supplied as provided by the energy statistics. Note that the storage facility was closed in 2008 (see below).

Therefore, data on the amount of gas oil supplied to Liechtenstein's storage facility has been collected from the Cooperative Society for the Storage of Gas Oil in the Principality of Liechtenstein (GHFL 2007, GHFL 2008). Actual consumption of gas oil in Liechtenstein has been calculated based on the total amount supplied according to national energy statistics minus supply to the stock (see Table 3-5).

Table 3-5 Total supply of gas oil as provided by Liechtenstein's energy statistics and fraction of supply that is supplied to Liechtenstein's stock (and may be further supplied to final consumers). Gas oil *consumption 1* is the difference of total supply minus supply to stock: (*Consumption 1 = Total supply - Supplied to stock*). This consumption is then corrected for actual density, resulting in *consumption 2*. The latter is then used for Liechtenstein's GHG Inventory. (*Consumption 2 = Consumption 1 * 0.845 / 0.840*).

Source	Total supply Energy Statistics	Supplied to stock GHFL 2008	Consumption 1 Calculated	Assumed density OEA-LIE	Consumption Calculated	Actual density FOEN 2012	Consumption 2 Calculated	Consumption Calculated
Year	Gas oil [t]	Gas oil [t]	Gas oil [t]	Gas oil [t/m ³]	Gas oil [m ³]	Gas oil [t/m ³]	Gas oil [t]	Gas oil [TJ]
1990	35'484	5'813	29'671	0.840	35'323	0.845	29'848	1'272
1991	29'240	3'207	26'033	0.840	30'991	0.845	26'188	1'116
1992	26'083	961	25'122	0.840	29'907	0.845	25'271	1'077
1993	28'531	792	27'739	0.840	33'023	0.845	27'904	1'189
1994	26'931	1'380	25'551	0.840	30'418	0.845	25'704	1'095
1995	25'004	159	24'845	0.840	29'578	0.845	24'993	1'065
1996	23'053	0	23'053	0.840	27'444	0.845	23'190	988
1997	26'443	200	26'243	0.840	31'241	0.845	26'399	1'125
1998	28'701	520	28'181	0.840	33'549	0.845	28'349	1'208
1999	24'774	45	24'729	0.840	29'439	0.845	24'876	1'060
2000	21'931	216	21'715	0.840	25'851	0.845	21'844	931
2001	21'098	435	20'663	0.840	24'599	0.845	20'786	885
2002	24'218	859	23'359	0.840	27'808	0.845	23'498	1'001
2003	24'871	116	24'755	0.840	29'471	0.845	24'903	1'061
2004	24'036	0	24'036	0.840	28'614	0.845	24'179	1'030
2005	23'100	98	23'002	0.840	27'383	0.845	23'139	986
2006	24'231	278	23'953	0.840	28'516	0.845	24'096	1'026
2007	14'549	352	14'197	0.840	16'902	0.845	14'282	608
2008	18'120	0	18'120	0.840	21'571	0.845	18'228	777
2009	20'368	0	20'368	0.840	24'248	0.845	20'489	873
2010	16'212	0	16'212	0.840	19'300	0.845	16'309	695
2011	14'183	0	14'183	0.840	16'885	0.845	14'267	608

In 2008, the storage facility has been closed down. From 2008 onwards, the amount supplied to the storage facility is therefore zero.

Gas oil supply is measured in volume units (litres, m³) and later reported to the Office of Environmental Protection in mass units (t). This conversion is made with a (rounded) density of 0.840 t/m³, whereas the more correct density is 0.845 t/m³ (FOEN 2012). Therefore, the *Consumption 1* is corrected accordingly, resulting in *Consumption 2*, as is shown in Table 3-5. Using a net calorific value of 42.6 GJ/t (FOEN 2012), the actual consumption in energy units results as used in Liechtenstein's GHG inventory. See also Table 3-3.

Natural gas: Natural gas consumption as published in the energy statistics (OS 2012a) is based on net natural gas imports. The amount of natural gas that leaks from the distribution network (reported under 1B2b) and is not burned at the final consumer's combustion system, is subtracted from the net imports in order to determine final consumption in 1A.

Gasoline / Diesel oil: A census carried out by the Office of Economic Affairs (OEA) revealed that values for fuel consumption came with large uncertainties. A number of distributors of gasoline and diesel report the amount of gasoline and diesel provided to domestic gasoline stations annually. Since not all distributors are known (they may come from any Swiss place and may differ every year), the census may not provide a complete statistics. Therefore, in 2000, the Office of Environmental Protection started a second census by direct questioning of all public gasoline stations. The results of this new census can be considered a complete overview of all gasoline and diesel oil sold to passenger cars (including also "tank tourism"²), but it covers only the years 2000-2011. For the years 1990-1999 (diesel: 1990-2001 see below), data compiled by OEA were collected in their original units (mass and volume units were used) and transformed into energy units by using the following densities and NCV. To ensure quality of time-series consistency an outlier and implied emission factor check is carried out as described in 2006 IPCC Guidelines (chapter 5 and 6). Both checks revealed that time series 1990-2011 are consistent.

Table 3-6 Values used for the entire period 1990-2011 (OEP 2006c, FOEN 2012). See also Table 3-3.

Parameter	unit	Gasoline	Diesel oil	Biodiesel
Density	kg/litre	0.745	0.830	0.920
NCV	GJ/t	42.5	42.8	37.6

For **gasoline** consumption, in 1990 the value of the energy statistics is used. For the years 1991-1999, a 3-years-mean is carried out (e.g. 1991: arithmetic mean of 1990, 1991, 1992). From 2000 to 2011, the values of the second census are used. The result of this modification is shown in Table 3-4 in row gasoline (OEP 2012c).

For **diesel oil** the amount sold at gasoline stations does not yet cover the whole amount consumed.

- There are private diesel stations, which are not part of the OEP census of public accessible gasoline stations. The holders of these private stations are mainly transport companies with heavy duty vehicles, construction companies with construction vehicles and farmers with agricultural machinery/vehicles. Because the diesel oil containers are subject to registration, the holders of these private diesel stations are known by the OEP. Based on this registration data, the OEP in 2002 started a further census of the diesel consumption by these private stations (OEP 2006c, OEP 2012c).
- Finally, consumption from the agriculture sector is known by subsequent information channel:
 - Until 2005: Farmers declared their purchase of diesel fuel and claimed refund of the fuel levy at the General Directorate of Swiss Customs, which was the collecting and refunding institution of fuel levies for fuel purchase in Switzerland and Liechtenstein, and which provided the OEP with the information about the amount declared annually by Liechtenstein's farmers. For simplification reasons, Switzerland has given up the refunding system.
 - Since 2005: The OEP collects the consumption data directly at the farmers by questionnaire. For the first time this was carried out in winter 2007 to collect the consumption data 2005, which was also available from the former method

² Like in Switzerland, gasoline stations sell relevant amounts of gasoline to foreign car owners due to fuel price differences between Liechtenstein/Switzerland (same prices) and Austria, Germany (higher gasoline prices). This amount of fuel is mainly consumed abroad (Therefore called "tank tourism"), but the whole amount must be reported as national under 1A3b Road transportation. For diesel oil, a similar tourism holds but inverse (import), because diesel oil is cheaper in Austria and Germany.

practised by the General Directorate of Swiss Customs. This allowed a quality control check. Since the difference was only 1%³ (OEP 2006c), both methods may be characterised as of equal and very high quality. The census is now being repeated annually.

- The OEP census for diesel oil therefore encompasses three parts: diesel oil of public gasoline stations (in improved census since 2000), diesel oil consumption of private stations (in census since 2002) and diesel oil consumption by farmers (data available for all years since 1990). The sum of these three parts, as available since 2002, is the total of diesel oil consumption.

For diesel oil, in 1990, the value is taken from the energy statistics. For the years 1991-2001, a 3-years-mean is carried out (e.g. 1991: arithmetic mean of 1990, 1991, 1992), because of low data quality. From 2002 to 2011, the values of the OEP census are used, because for these years data of high quality is available. The result of this modification is shown in Table 3-4 in line "diesel".

Kerosene: The fuel sales at the single helicopter base have been reported in detail (domestic, international/bunker) for 2001–2011 and less detailed for 1995 (Rhein Helikopter 2006–2012). For the other years in the reporting period, adequate assumptions were made (see Section 3.2.6.3).

Bunker (kerosene, civil aviation): See Section 3.2.2.

Biomass: See Section 3.2.5.1.

3.1.3.2 Energy Statistics and Contribution to the IPCC Source Categories

a) Gas oil

No data on the specific contribution of Source Categories 1A2, 1A4a and 1A4b to total gas oil consumption in 1A Fuel Combustion Activities is currently available. Therefore, the following rough estimated shares based on expert judgement are assumed for all years from 1990 to 2011: The energy statistics of Liechtenstein only indicates the total consumption of gas oil. Therefore, the distribution between the different sectors had to be evaluated by experts for all years from 1990 till 2010. The experts of Liechtenstein assumed that the distribution of the gas oil consumption is distributed by 60% on the commercial and institutional sector and 20% each for the manufacturing industries and the residential sector. As there has not been any significant change in the different sectors regarding gas oil consumption nor any switch from the gas oil consumption from one sector to the other, no change of the distribution is expected between 1990 and 2011.

Table 3-7 Estimated share of source categories in total consumption of gas oil in 1A Fuel Combustion Activities.

Source category		Share in consumption of gas oil (1990-2011)
1A2	Manufacturing Industries and Construction	20%
1A4a	Other Sectors - Commercial/Institutional	60%
1A4b	Other Sectors - Residential	20%
Total 1A		100%

³ Consumption due to General Directorate of Swiss Customs 514'759 litres of diesel oil, due to questionnaire: 520'618 litres. Difference 5859 litres (1.1%). Data source OEP 2007a.

b) Natural gas

The data on total consumption of natural gas in Liechtenstein is provided by the gas utility (LGV 2012) and published in the national energy statistics (OS 2012). It refers to the net import.

For the partition of natural gas consumption between the different combustion activities in 1A, only limited data is available. Even though the gas utility publishes statistics of natural gas consumption of different groups of its customers, the definition of these groups is not fully in line with IPCC source categories and appears also somewhat arbitrary. The following tentative attribution is used:

Table 3-8 Tentative correspondence between IPCC source categories and categories in Liechtenstein's natural gas (NG) consumption statistics.

	IPCC Source Category	Corresponding category in NG statistics	
		(English)	(German)
1A1a	Public Electricity and Heat Production	Co-generation	Blockheizkraftwerke
1A2	Manufacturing Industries and Construction	Industry	Industrie
1A3b	Road Transportation	Fuel for transportation	Treibstoff
1A4a	Other Sectors - Commercial/Institutional	Services	Gewerbe/Dienstleistungen und Öffentliche Hand
1A4b	Other Sectors - Residential	Residential/Households	Wohnungen/Haushalt

c) Gasoline

The entire amount of gasoline sold is attributed to 1A3b Road Transportation.

Alkylate gasoline is attributed 20% to 1A4b and 80% to 1A4c. This attribution is based on an expert estimate which takes into account that most of the alkylate gasoline is used in forestry. The amount sold (activity data) is collected by a census in 2008 of about 80% of the selling stations and consumers (OEP 2009b). Data of the year 2011 is then extrapolated for the entire country. To calculate the time series until 1995 when selling of alkylate gasoline in Liechtenstein started, the developing of consumption values of the two biggest consumers were analysed and these trends adapted to the extrapolation (linear) of the total sales in Liechtenstein back to 1996. For 1995, the year in which the selling started, only 50% of the 1996 amount sold, was taken.

d) Diesel oil

The diesel consumption, which stems from three different data sources, is attributed to the source categories according to the following assumptions (private diesel tanks: see section a. National Energy Statistics and Modifications above).

Table 3-9 Data sources for the diesel consumption and its attribution to IPCC source categories for the period 1990-2011 (Acontec 2006).

Shares of diesel sales	1A3b Road Transportation	1A4c Other Sect./Agriculture	1A5b Other/Mobile	Sum
Data source				
Questioning gasoline stations	100%	0%	0%	100%
Diesel "tanks"	70%	0%	30%	100%
"Oberzolldirektion"	0%	100%	0%	100%

Note

Please note that for the Swiss greenhouse gas inventory, the data for source category 1A Fuel Combustion from the Swiss Overall Energy Statistics is corrected for the gasoil consumption in Liechtenstein (FOEN 2012). In the Swiss GHG Inventory, the gasoil

consumption in Liechtenstein is subtracted from the fuel consumption from the Swiss Overall Energy Statistics (that includes Liechtenstein's consumption). Therefore, a potential overestimation (underestimation) of fuel consumption in Liechtenstein is fully compensated by a related underestimation (overestimation) of fuel consumption in Switzerland.

3.2 Source Category 1A – Fuel Combustion Activities

3.2.1 Comparison Sectoral Approach - Reference Approach

3.2.1.1 Comparison of Sectoral Approach with Reference Approach

The Reference Approach uses Tier 1 methods for the different source categories of the energy sector, whereas the National (Sectoral) Approach uses specific methods for the different source categories. For the Inventory of the Framework Convention and the Kyoto Protocol the Sectoral Approach is used. The Reference Approach is only used for controlling purposes (quality control).

Due to the close relations with Switzerland, similar economic structures, the same liquid/gaseous fuels and a similar vehicle fleet composition, a large number of emission factors, especially for CO₂, are taken from the Swiss greenhouse gas inventory. The oxidation factor is consequently set to 1.0 due to the following reason: combustion installations in Liechtenstein have very good combustion properties; combined emissions of CO and unburnt VOC lie in the range of only 0.1 to 0.3 percent of CO₂ emissions for oil and gas combustion. Also for coal an oxidation factor of 1.0 was used for conservative reasons and due to the negligible quantity consumed, which results in an emission of 0.00494 Gg CO₂ in 2011. This is consistent with the information and assumptions from the Inventory of Switzerland.

Conversion factors (TJ/unit) and carbon emission factors (t C /TJ) in CRF table 1.A(b) have been taken from Table 3-3 and are therefore identical to the ones used for the Sectoral Approach.

The apparent consumption, the net carbon emissions and the effective CO₂ emissions are calculated for the Reference Approach as prescribed in the CRF tables 1A(b)–1A(d). Data is taken from the energy statistics as described in chapter 3.1.3. The Reference Approach covers the CO₂ emissions of all imported fuels. Since there is no production nor import of primary fuels into Liechtenstein but only imports of secondary fuels, the calculation of the fuel consumption in the Reference Approach leads to the same result as the Sectoral Approach.

The following table and the figure show the differences between the Reference and the Sectoral (National) Approaches 1990–2011. Energy consumption differs between the two approaches by 0.09%, whereas CO₂ emissions show slight differences of maximally 0.03%.

While congruence between Reference and Sectoral Approach for energy consumption is high, the difference concerning CO₂ is even smaller. The most probable explanation for this, is the fact, that a small fraction of the gas consumed is not burnt but lost before in the distribution network. Therefore these emissions are more climate relevant as they are emitted as CH₄ with higher warming potential (21 CO₂ eq) than if burnt and emitted as CO₂. Consequently, the results of the Reference Approach, which considers this fact, become larger compared to the Sectoral Approach results. As the importance of gas is increasing in Liechtenstein also the differences between the two approaches are increasing.

Table 3-10 Differences in energy consumption and CO₂ emissions between the Reference and the Sectoral (National) Approach. The difference is calculated according to $[(RA-SA)/SA]$ 100% with RA = Reference Approach, SA = Sectoral (National) Approach.

Difference between Reference and Sectoral Approach										
	1990	1991	1992	1993	1994	1995	1996	1997	1998	1999
	percent (%)									
Energy Consumption	0.02	0.03	0.04	0.04	0.04	0.05	0.05	0.05	0.05	0.05
CO ₂ Emissions	0.01	0.01	0.02	0.02	0.02	0.02	0.01	0.01	0.01	0.02

	2000	2001	2002	2003	2004	2005	2006	2007	2008	2009
	percent (%)									
Energy Consumption	0.06	0.06	0.06	0.06	0.07	0.07	0.07	0.08	0.08	0.08
CO ₂ Emissions	0.02	0.02	0.02	0.02	0.02	0.03	0.03	0.03	0.03	0.03

	2010	2011
	percent (%)	
Energy Consumption	0.09	0.09
CO ₂ Emissions	0.03	0.03

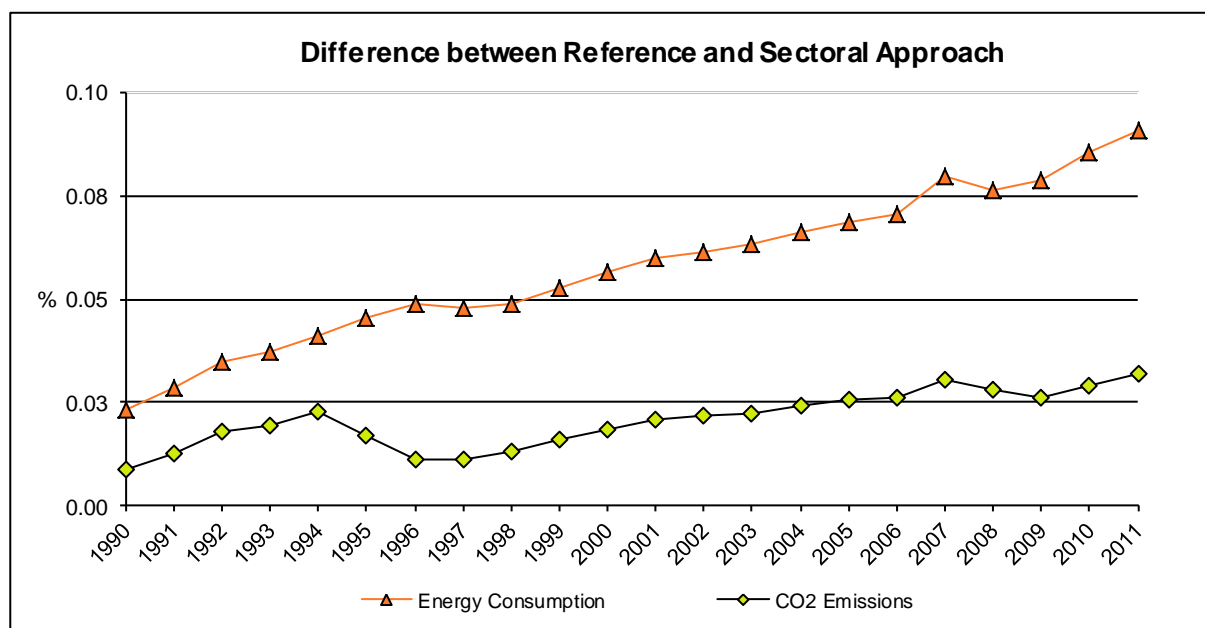

Figure 3-3 Time series for the differences between Reference and Sectoral Approach. Numbers are taken from the table above.

3.2.1.2 Recalculation in the Reference Approach

No recalculation has been carried out for the Reference Approach.

3.2.2 International Bunker Fuels

For Liechtenstein, the only source of international bunker emissions is civil aviation (one helicopter landing site). Total emissions of civil aviation are calculated as described in Section 3.2.6.8 with Tier 1 method. The share of consumption for international flights is provided by the two operating companies of the helicopter landing site Rhein-Helikopter AG and Rotex Helikopter AG. In 1995 a pre-study was conducted at the two operating

companies that determined the share to be 85% for international flights. A second and more comprehensive study was conducted in 2001 and 2002 that determined the share to be 84% in 2001 and 86% in 2002. Based on this information a linear interpolation between the years 1995 and 2002 is applied for the shares in the years between. For the years 1990-1994 a fixed share at 85% as determined in 1995 was set. For all other years, the mean value (85%) is used. Since there are only two helicopters operated in Liechtenstein, activity data is highly dependent on the annual demand for these helicopters and thus emissions change significantly in years with high or low demand for flying (passengers and freight transportation). Marine bunker emissions are not occurring.

Table 3-11 Kerosene (civil aviation) due to sales principle: International flights (bunker, memo item), domestic flights (reported under 1A3a) and total. Data source: Rhein Helikopter (2006, 2007, 2008, 2009, 2010, 2011,2012).

Kerosene	1990	1991	1992	1993	1994	1995	1996	1997	1998	1999
	TJ									
international (bunker)	5.84	5.84	5.84	5.84	5.84	5.84	6.00	6.16	6.33	6.49
domestic (1A3a)	1.03	1.03	1.03	1.03	1.03	1.03	1.04	1.05	1.06	1.07
total	6.87	6.87	6.87	6.87	6.87	6.87	7.04	7.21	7.39	7.56

Kerosene	2000	2001	2002	2003	2004	2005	2006	2007	2008	2009
	TJ									
international (bunker)	6.66	6.82	6.12	6.74	4.82	6.52	10.47	10.36	10.14	12.08
domestic (1A3a)	1.08	1.09	1.14	1.19	0.85	1.15	1.85	1.83	1.79	2.13
total	7.74	7.91	7.26	7.93	5.68	7.67	12.32	12.18	11.93	14.21

Kerosene	2010	2011
	TJ	
international (bunker)	10.59	11.34
domestic (1A3a)	1.87	2.00
total	12.46	13.34

3.2.3 Feedstocks and Non-Energy Use of Fuels

Energy data are taken from Liechtenstein's energy statistics (OS 2012a). These statistics account for production, imports, exports, transformation and stock changes. Hence all figures for energy consumption, on which the Swiss GHG inventory is based, correspond to apparent consumption figures.

No bitumen and lubricants are produced in Liechtenstein. There is no production nor import of primary fuels in or into Liechtenstein. Bitumen is imported for road paving and CO and NMVOC emissions from bituminous materials are related to asphalt roofing and road paving and reported in sectors 2A5 and 2A6. However, use of bitumen does not affect fuel consumption data in Liechtenstein, which are only based on imports of secondary fuels. It is assumed that the fraction of carbon stored in bitumen is 1, meaning that there are no CO₂ emissions from bitumen.

3.2.4 CO₂ Capture from Flue Gases and Subsequent CO₂ Storage

Not applicable for Liechtenstein.

3.2.5 Country-Specific Issues

3.2.5.1 CO₂ Emissions from Biomass

A description of the methodology for calculating CO₂ emissions from the combustion of biomass and the consumption of biofuels is included in the relevant Chapters 3.2.6.6 / 3.2.6.8 / 3.2.6.9 (Energy) and 8 (Waste).

3.2.6 Source Category 1A

3.2.6.1 Source Category Description: Energy Industries (1A1)

Key categories 1A1

CO₂ from the combustion of Gaseous Fuels in Energy Industries (1A1) is a key category regarding level and trend.

According to IPCC guidelines, source category 1A1 “Energy Industries” comprises emissions from fuels combusted by fuel extraction and energy producing industries.

In Liechtenstein 1A1 includes only emissions from the production of heat and/or electricity for sale to the public in 1A1a Public Electricity and Heat Production. Petroleum Refining (1A1b) and Manufacture of Solid Fuels and Other Energy Industries (1A1c) do not occur.

Table 3-12 Specification of source category 1A1 “Energy Industries” (AD: activity data; EF: emission factors)

1A1	Source	Specification	Data Source
1A1 a	Public Electricity and Heat Production	This source consists of natural gas or biogas ⁴ fuelled public co-generation units.	AD: OS 2012a EF: SAEFL 2005, IPCC 1997c
1A1 b	Petroleum Refining	Not occurring	-
1A1 c	Manufacture of Solid Fuels and Other Energy Industries	Not occurring	-

In 2011, 18% of Liechtensteins electricity consumption was produced domestically and 82% was imported.

In absolute values, the electricity consumption was around 398 GWh in 2011 compared to around 397 GWh in 2010. This corresponds to an increase of 0.4% whereas the domestically produced power decreased by 8.5% and the electricity imports increased by 2.6%. (see Table 3-13).

Table 3-13 Electricity consumption, generation and imports in Liechtenstein in 2011. Data source Energy Statistics 2011 (OS 2012a).

Total consumption Liechtenstein 2011 [MWh]	398'241	100%
Power generation in Liechtenstein 2011	72'239	18%
Hydro power	62'182	
Natural gas co-generation	3'018	
Biogas co-generation	876	
Photovoltaic	6'163	
Imports	326'002	82%

⁴ Biogas from sewage sludge in waste water treatment.

Domestic electricity generation is dominated by hydroelectric power plants (see Figure 3-4). Other electricity sources are photovoltaic plants as well as fossil and bio fuelled combined heat and power generation plants.

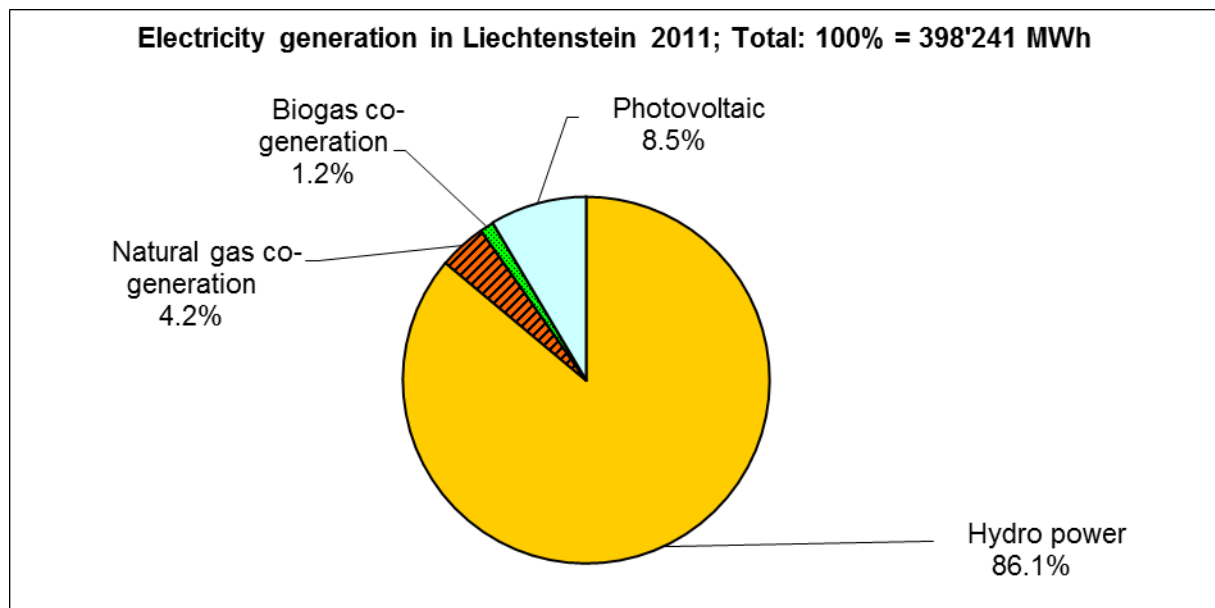

Figure 3-4 Structure of electricity generation in Liechtenstein 2011. Data source: Energy Statistics 2011 (OS 2012a).

Renewable sources account for 95.8% of domestic electricity generation in Liechtenstein. Compared to 2010, the electricity produced by photovoltaic plants has increased by over 118% from 2'825 MWh to 6'163 MWh. Photovoltaic is thus representing 8.5% of the total electricity production in 2011 (while it was only 3.6% in 2010 and 1.3% in 2009).

Waste incineration plants do not exist in Liechtenstein and municipal solid waste is exported to Switzerland for incineration. Therefore, no heat and/or electricity production from waste incineration plants is occurring in Liechtenstein.

Source category 1A1 includes therefore only emissions from gaseous fuels and biomass consumption.

3.2.6.2 Source Category Description: Manufacturing Industries and Construction (1A2)

Key categories 1A2

CO₂ from the combustion of Gaseous Fuels and Liquid Fuels in Manufacturing Industries and Construction (1A2) is a key category regarding both level and trend.

The source category 1A2 "Manufacturing Industries and Construction" includes industrial auto-production of heat and electricity. The category comprises all emissions from the combustion of fuels in stationary boilers, gas turbines and engines within manufacturing industries and construction. .

The following industries are not occurring in Liechtenstein: Iron and Steel, Non-ferrous Metals, Chemicals as well as Pulp and Paper.

Because data needed for the disaggregation of fuel consumption between the categories 1A2e and 1A2f is not available, all emissions related to Manufacturing Industries and Construction are reported under 1A2f Other.

Table 3-14 Specification of source category 1A2 "Manufacturing Industries and Construction" (AD: activity data; EF: emission factors)

1A2	Source	Specification	Data Source
1A2 a	Iron and Steel	Not occurring.	-
1A2 b	Non-ferrous Metals	Not occurring.	-
1A2 c	Chemicals	Not occurring.	-
1A2 d	Pulp, Paper and Print	Not occurring.	-
1A2 e	Food Processing, Beverages and Tobacco	Included in 1A2f.	-
1A2 f	Other (Combustion Installations in Industries)	Category 1A2 f contains all emissions related to 1A2.	AD: OS 2012a EF: SAEFL 2000a

3.2.6.3 Source Category Description: Transport (1A3)

Key categories 1A3b

CO₂ from the combustion of gasoline (level and trend)

CO₂ from the combustion of diesel (level and trend)

CO₂ from the combustion of gaseous fuels (level and trend)

The source contains road transport and national civil aviation. Civil aviation in fact is only a very small contribution resulting from one only helicopter base in Liechtenstein. Railway is not producing emissions (see below), navigation and other transportation are not occurring. Further off-road transportation is included in category 1A4 Other Sectors (off-road transport in agriculture and forestry) and in 1A5 Other (off-road, e.g. construction).

Table 3-15 Specification of Liechtenstein's source category 1A3 "Transport" (AD: activity data; EF: emission factors).

1A3	Transport	Specification	Data Source
1A3a	Civil Aviation (National)	Helicopters only	AD: Rhein Helikopter AG 2006-2012, Acontec 2006 EF: FOEN 2012, IPCC 1997c
1A3b	Road Transportation	Light and heavy motor vehicles, coaches, two-wheelers	AD: OS 2012a, OEP 2006c, EF: FOEN 2011, IPCC 1997c
1A3c	Railways	Fully electrified system, no electricity infeed, no diesel locomotives, shunting yards	---
1A3d-e	Navigation, military aviation	Not occurring	---

3.2.6.4 Source Category Description: Other Sectors (1A4 – Commercial/Institutional, Residential, Agriculture/ Forestry)

Key categories 1A4a, 1A4b

CO₂ from the combustion of gaseous and liquid fuels in the Commercial/Institutional Sector (1A4a) and in the Residential Sector (1A4b) are key categories regarding both level and trend.

Source category 1A4 “Other sectors” comprises emissions from fuels combusted in commercial and institutional buildings, in households, as well as emissions from fuel combustion for grass drying and off-road machinery in agriculture.

Table 3-16 Specification of source category 1A4 “Other sectors” (AD: activity data; EF: emission factors).

1A4	Source	Specification	Data Source
1A4 a	Commercial/ Institutional	Emission from fuel combustion in commercial and institutional buildings	AD: OS 2012a EF: SAEFL 2000a; UBA 2004, SFOE 2001
1A4 b	Residential	Emissions from fuel combustion in households	AD: OS 2012a EF: FOEN 2011; SAEFL 2000a; SFOE 2001
1A4 c	Agriculture/ Forestry/ Fishing	Comprises fuel combustion for agricultural machinery.	AD: OS 2012a, OEP 2011c EF: SAEFL 2000a; SFOE 2001; INFRAS 2008

3.2.6.5 Source Category Description: Other – Off-road: Construction and Industry (1A5)

Key categories 1A5b

CO₂ from the combustion of liquid fuels in 1A5 Other – Off-road is a key category regarding trend and level.

In Liechtenstein, the source categories are defined according to the next table. The IPCC category structure distinguishes stationary (1A5a) and mobile (1A5b) sources. In Liechtenstein, the main sources are construction and industrial vehicles. All emissions are therefore reported under 1A5b Mobile. 1A5a Stationary sources are not reported. Should some of them occur in reality, their emissions would not be neglected but would appear under 1A5b since the emission of the total amount of fuel sold is included in the modelling.

Table 3-17 Specification of Liechtenstein's source category 1A5b “Other, Mobile” (off-road).

1A5b	Off-road	Specification	Data Source
	Construction	Construction vehicles and machinery	EF: INFRAS 2008
	Industry	Industrial off-road vehicles and machinery	AD: OEP 2012c

3.2.6.6 Methodological Issues: Energy Industries (1A1)

Methodology

For fuel combustion in Public Electricity and Heat Production (1A1a), the only occurring Source within 1A1 Energy Industries, a Tier 2 method is used.

Aggregated fuel consumption data from the energy statistics of Liechtenstein (OS 2012a) is used to calculate emissions. As mentioned above, only gaseous fuels and biomass are occurring within this category.

The sources are characterised by similar industrial combustion processes and the same emission factors are applied.

Emissions of GHG are calculated by multiplying fuel consumption (in TJ) by emission factors.

Emission Factors

The emission factors for CO₂ and CH₄ are country specific and representative for engines used in Switzerland and Liechtenstein (lean fuel-air-ratio). Therefore, emission factors have been taken from Switzerland (SAEFL 2005).

For the N₂O emissions the default emission factors from IPCC 1997c have been used.

Biomass: Country specific emission factors for biogas from wastewater treatment plants are taken from SAEFL 2005. The emission factor of biogenic CO₂ has been adapted to take into account CO₂ being present in the biogas as a product of fermentation already prior to combustion.⁵

The following table presents the emission factors used in 1A1a.

Table 3-18 Emission Factors for 1A1a Public Electricity and Heat Production in Energy Industries for all years 1990 - 2011 (public co-generation).

Source/fuel	CO ₂ t/TJ	CO ₂ bio. t/TJ	CH ₄ kg/TJ	N ₂ O kg/TJ
1A1a Public Electricity/Heat				
Natural gas	55	NO	25	0.1
Biomass (biogas from WWTP)	NO	100.5	6	11

Activity Data

Activity data on natural gas consumption (in TJ) for Public Electricity and Heat Production (1A1a) is extracted from the energy statistics (OS 2012a).

⁵ The CO₂ emission factor of 100.5 t biogenic CO₂ / TJ biogas is based on the assumption that 35% of the volume of the biogas is CO₂ and 65% CH₄.

Table 3-19 Activity data for natural gas and biomass consumption in 1A1a Public Electricity/Heat Production.

Source/fuel	1990	1991	1992	1993	1994	1995	1996	1997	1998	1999
1A1a Public Electricity/Heat Fuel Consumption	TJ									
Natural gas	2.16	14.04	32.40	33.48	31.32	35.64	44.64	43.56	50.40	50.40
Biomass	15.57	16.32	17.28	17.28	18.75	16.98	18.12	18.44	19.96	21.49

Source/fuel	2000	2001	2002	2003	2004	2005	2006	2007	2008	2009
1A1a Public Electricity/Heat Fuel Consumption	TJ									
Natural gas	47.52	50.40	43.20	48.60	50.76	54.00	48.96	44.28	50.04	51.12
Biomass	21.70	20.87	20.00	20.73	21.64	20.82	22.54	24.26	25.03	23.66

Source/fuel	2010	2011
1A1a Public Electricity/Heat Fuel Consumption	TJ	
Natural gas	56.16	52.56
Biomass	22.24	22.49

The table above documents the increase of natural gas consumption by a factor of 24 from 1990 to 2011. The rapid increase in the years 1990 – 1992 can be explained by the significant expansion of the natural gas red and increasing connections within Liechtenstein. This increase is the reason why gaseous fuels of 1A1 is a key category regarding trend.

Activity data on biogas consumption from waste water treatment plants are provided by plant operators (for data see section 8.3).⁶

3.2.6.7 Methodological Issues: Manufacturing Industries and Construction (1A2)

Methodology

For fuel combustion in Manufacturing Industries and Construction (1A2), whereas all emissions are reported under the source 1A2f, a Tier 2 method is used.

A top-down method based on aggregated fuel consumption data from the energy statistics of Liechtenstein (OS 2012a) is used to calculate CO₂ emissions of 1A2f.

The sources are characterised by rather similar industrial combustion processes and assumingly homogenous emission factors, where a top-down approach is feasible. Therefore, identical emission factors for each fuel type are applied throughout these sources. The unit of emission factors refers to fuel consumption (in TJ).

An oxidation factor of 100% is assumed for all combustion processes and fuels because technical standards for combustion installations in Liechtenstein are relatively high (see section 3.2.1.1).

Emissions of GHG are calculated by multiplying levels of activity by emission factors.

Emission factors

The emission factors for CO₂ are country specific and are based on measurements and analysis of fuel samples carried out by the Swiss Federal Laboratories for Materials Testing and Research EMPA (carbon emission factor documented in SFOE 2001, Table 45, p. 51).

Emission factors for CH₄ are country specific and based on comprehensive life cycle analysis of industrial boilers in Switzerland, documented in SAEFL 2000a (pp. 14-27).

⁶ Activity data for biogas is provided in m³. A density of 1.2 kg/m³ and a lower calorific value of 19.2 MJ/kg is used to calculate the energy content.

For the N₂O emissions the default emission factors from IPCC 1997c have been used.

The following table presents the emission factors used for the sources in category 1A2f:

Table 3-20 Emission factors for sources in 1A2f for all years 1990 - 2011.

Source/fuel	CO ₂ t/TJ	CH ₄ kg/TJ	N ₂ O kg/TJ	NO _x kg/TJ
1A2 f Other				
Gas oil	73.7	1.0	0.6	NE
Natural Gas	55.0	6.0	0.1	NE

Activity data

Activity data on fuel consumption (TJ) are based on aggregated fuel consumption data from the energy statistics of Liechtenstein (OS 2012a).

The resulting disaggregated fuel consumption data for 1990 to 2011 is provided in the table below.

Table 3-21 Activity data fuel consumption in 1A2f Manufacturing Industries and Construction 1990 to 2011

Source	1990	1991	1992	1993	1994	1995	1996	1997	1998	1999
	TJ									
1A2f Other	554	545	546	572	546	550	555	574	611	610
Gas oil	254	223	215	238	219	213	198	225	242	212
Natural gas	300	322	331	334	327	338	358	349	369	398

Source	2000	2001	2002	2003	2004	2005	2006	2007	2008	2009
	TJ									
1A2f Other	559	566	578	622	608	589	609	519	546	372
Gas oil	186	177	200	212	206	197	205	122	155	175
Natural gas	373	389	378	410	402	392	404	397	390	197

Source	2010	2011
	TJ	
1A2f Other	359	310
Gas oil	139	122
Natural gas	220	188

Table 3-21 documents the net decrease of gas oil consumption by 52% from 1990 to 2011. This decrease is related to the extension of the natural gas-grid in Liechtenstein which replaced gas oil as the main heating fuel in buildings. The gas oil consumption had a sharp decrease in 2007 followed by increases in 2008 and 2009 and another decrease in 2010 which are discussed below under source category 1A4 Other Sectors.

During the same period, the natural gas consumption decreased by 37%. This significant decrease in the natural gas consumption can be explained by the installation of the new district heating pipeline. This new district heating facility installed in 2009 delivers heat from the onsite waste incineration plant in Buchs, SG in Switzerland. Related emissions are occurring in Switzerland and therefore reported in the inventory of Switzerland. Fluctuations in the natural gas consumption can be explained by the changing heating needs in cold or warm winters. For example, the increase in natural gas consumption in 2010 can be explained by the increased heating needs for the winter 2009/2010 as this was a relatively cold winter.

This shift in fuel mix is the reason for CO₂ emissions from gaseous and liquid fuels in category 1A2 being key categories regarding trend. In addition, the district heating from Switzerland installed in 2009 reduced the overall activity from category 1A2 by 44%.

3.2.6.8 Methodological Issues: Transport (1A3)

Key categories 1A3b

CO₂ from the combustion of gasoline (level and trend)

CO₂ from the combustion of diesel (level and trend)

CO₂ from the combustion of gaseous fuels (level and trend)

In Liechtenstein, 1A3 Transport mainly consists of source category 1A3b Road Transportation and a minor contribution of 1A3a Civil Aviation.

a) Aviation (1A3a)

Methodology

The emissions are estimated based on the fuel consumption, flying hours and the fleet composition of Liechtenstein's single helicopter base.

It must be noted, that these emissions are also reported in the Swiss GHG inventory. Since Switzerland and Liechtenstein form a customs union, all imports of kerosene appear in the Swiss overall energy statistics. The Swiss Federal Office of Civil Aviation (FOCA) carries out an extended Tier 3a method to determine the domestic (and bunker) emissions of civil aviation. Within this calculation, all fuel consumption of helicopters is accounted for. The helicopter basis in Balzers/Liechtenstein is included in this modelling scheme. All resulting emissions from helicopters are reported in the Swiss inventory as domestic emissions. The amount of emissions from the Balzers helicopter basis is very small compared to the total of Swiss helicopter emissions. Therefore, Switzerland disclaimed to subtract the small contribution of emissions from its inventory. Nevertheless, for Liechtenstein these emissions are not negligible. They are calculated using a Tier 1 method.

Emissions Factors

Table 3-22 Emission factors used for estimating emissions of helicopters. The values are used for the entire time series 1990-2011.

Emission factors	CO ₂ t/TJ	CH ₄ kg/TJ	N ₂ O kg/TJ
1A3a Civil aviation/ helicopters	73.2	0.5	2.3
data source	FOEN 2012	IPCC 1996	IPCC 1996

Activity Data

The two operating companies of the helicopter base provided data on fuel consumption for 1995, 2001–2011 as well as detailed flying hours, shares of domestic and international flights as well as specific consumption of the helicopter fleet for 2001–2002 (Rhein Helikopter 2006-2012). The fleet consists of:

- Company Rhein-Helikopter AG: Helikopter AS 350 B-3 Ecureuil, 180 litre/hour
- Rotex Helicopter AG: Helikopter Kamax K 1200, 320 litres/hour

From the shares of domestic flights in 2001 (14%) and in 2002 (16%), a mean share of 15% was adopted for all other years in the period 1990–2000 and 2003–2011. The consumption 1990–1994, which is not available anymore, is assumed to be constant and equal to 1995. The consumption for 1996–2000 was linearly interpolated between 1995 and 2001.

Table 3-23 Activity data for civil aviation: Kerosene consumption 1990-2011 in TJ (only domestic consumption without international bunker fuel).

Kerosene	1990	1991	1992	1993	1994	1995	1996	1997	1998	1999
	TJ									
1A3a Civ. Aviation (domestic)	1.03	1.03	1.03	1.03	1.03	1.03	1.04	1.05	1.06	1.07

Kerosene	2000	2001	2002	2003	2004	2005	2006	2007	2008	2009
	TJ									
1A3a Civ. Aviation (domestic)	1.08	1.09	1.14	1.19	0.85	1.15	1.85	1.83	1.79	2.13

Kerosene	2010	2011
	TJ	
1A3a Civ. Aviation (domestic)	1.87	2.00

b) Road Transportation (1A3b)

Methodology

The emissions are calculated with a Tier 1 method (top-down) as suggested by IPCC Good Practice Guidance using Swiss emission factors. The CO₂ emission factors are derived from the carbon content of fuels (see Table 3-3). For CH₄ and N₂O, the country specific implied emission factors of the Swiss greenhouse gas inventory are applied. The activity data corresponds to the amounts of gasoline and diesel fuel sold in Liechtenstein (sales principle). These numbers are taken from the national energy statistics modified as mentioned in Chapter 3.1.3. For Liechtenstein, "tank tourism" is a very important feature of the gasoline sales, since the prices in the neighbouring Austria are much higher than in Liechtenstein and Switzerland (which both have the same price due to the Customs Union Treaty). Furthermore a large number of Austrian and German citizens are working in Liechtenstein (figures for the year 2011 – more recent figures will not be available until March 2013: 34'334 registered employees, 17'570 commuters, whereas 48.8% of the commuters are non-Swiss citizens) and buying their gasoline in Liechtenstein (OS 2012b). The method of reporting the fuel sold at all gasoline stations in the country guarantees that indeed the sales principle is applied and not a territorial principle as might be the case by applying a traffic model, which, for Liechtenstein, would considerably underestimate the fuel sold.

Emission Factors

The emission factors for gasoline and diesel oil are adopted from Switzerland:

- CO₂ for fossil gasoline, diesel oil and natural gas: The emission factors are taken from Table 3-3. They are kept constant over the entire time period 1990–2011 as done in Switzerland.
- CO₂ for biofuel: No production of biofuel occurs. However, in the years 2007-2009 there was one distributor in Liechtenstein who imported biofuels, mixed them with other fuel types and then sold the fuel. This is not considered to be a "production of biofuels" and thus in CRF Table 1A(b) there is only data provided for import and export of the biogenic compounds of the fuel. The fuel was based on recycling of waste vegetable oil consisting mainly of canola. A small fraction of fossil diesel oil was added to the vegetable fuel. The fossil fraction is contained in the diesel sold and therefore has not to

be accounted again (to avoid double counting), whereas the biogenic fraction is not reported under 1A3b but under Memo items "biomass". An emission factor of 73.6 t/TJ is assumed (FOEN 2012). However, in 2010 the importer ceased activity and thus in Liechtenstein no sale of biofuels occurs anymore.

- CH₄, N₂O for gasoline and diesel oil: The implied emission factors of the Swiss CRF Table 1.A(a)s3 (rows 1A3b Road Transportation Gasoline / Diesel oil) are used for the period 1990–2009. From the year 2009, a new traffic model with updated implied emission factors has been used for the Swiss CRF and thus implied emission factors have changed for Liechtenstein accordingly. The updated values are also incorporated in the CRFs of Liechtenstein, since for the year 2010, the Swiss values 2009 have been used according to the assumptions of Chpt. 1.4.1.2. Note that the regulation for emission concepts of the two countries are identical: Switzerland and Liechtenstein adopt the same limit values for pollutants on the same schedule as the countries of the European Union. The fleet composition of the two countries, the CO₂ emissions of light motor vehicles (passenger cars, light duty vehicles, motorcycles) and the emissions of heavy motor vehicles (heavy duty vehicles, buses, coaches) are similar in Liechtenstein and Switzerland. A quantitative analysis based on the traffic models of Switzerland (INFRAS 2004, Annex A5) and of Liechtenstein (OEP 2002, Table 7, p. 16) shows: The contribution of light motor vehicles to the CO₂ emissions of the total (light and heavy motor vehicles) is 80% in Liechtenstein and 85% in Switzerland. Note that these results are derived based on the territorial principle. From the viewpoint of the sales principle, both numbers would be higher due to tank tourism, but in Liechtenstein, the increase would be stronger since tank tourism is more pronounced in Liechtenstein than in Switzerland. It can therefore be expected that if tank tourism were considered, the two figures 80% and 85% would converge even more. This comparison underpins the applicability of Swiss implied emission factors for Liechtenstein. Annual variation in the implied emission factors may reach a few percent. But since the emission factors for CO₂ remain unchanged, the deviation of the emission total of source category 1A3b is very small: The recalculation for 2010 shows a difference in CO₂ eq. of 0.18% due to the recalculation of the N₂O and CH₄ emissions factors of 1A3b between the latest and the previous submission. The emissions 2011 will be recalculated for the submission 2014.
- CH₄, N₂O for natural gas: From 2010 onward, there are implied emission factors available in the Swiss CRF. As for gasoline and diesel, the implied emission factors of the Swiss CRF are used for the period 2001-2011 (see NIR Switzerland 2012, page 129).

In lieu of reviewed emission factors for biofuels the following assumptions were made:

- Biodiesel and vegetable/waste oil: The implied emission factors 1A3b for fossil diesel are used. Values for 2010:
CO₂ 73.6 t/TJ; CH₄ 0.37 kg/TJ; N₂O 2.06 kg/TJ
- Bio ethanol: The implied emission factors 1A3b for gasoline are used. Values for 2010:
CO₂ 73.9 t/TJ; CH₄ 8.07 kg/TJ; N₂O 1.05 kg/TJ
- Biogas: The implied emission factors 1A3b for CNG are used. Values for 2010:
CO₂ 55.0 t/TJ; CH₄ 5.40 kg/TJ; N₂O 3 kg/TJ

Accordingly the same reasoning applies as for the use of other Swiss IEF for transportation in general for Liechtenstein (see chapter 1.4.1.1 in NIR Liechtenstein 2012).

Table 3-24 Emission factors for road transport. The values for gasoline and diesel oil are adopted from the Swiss GHG inventory (implied emission factors from CRF Table1.A(a)s3, NIR CH, FOEN 2012). For gaseous fuels, IPCC default values are used (IPCC 1997c). Swiss factors for 2011 are not available yet. For the emission modelling, they are provisionally set equal to the factors 2010. For biofuel (waste vegetable oil), the CO₂ emission factor is given only in addition since it is of biogenic origin.

Gas	unit	1990	1991	1992	1993	1994	1995	1996	1997	1998	1999	2000	2001	2002	2003	2004	2005	2006	2007	2008	2009	
Gasoline																						
CO ₂	t/TJ	73.9	73.9	73.9	73.9	73.9	73.9	73.9	73.9	73.9	73.9	73.9	73.9	73.9	73.9	73.9	73.9	73.9	73.9	73.9	73.9	
CH ₄	kg/TJ	31.4	28.5	25.8	23.7	21.4	19.7	18.3	17.0	15.7	14.6	13.6	12.8	11.9	11.0	10.5	10.0	9.3	9.00	8.62	8.32	
N ₂ O	kg/TJ	2.9	2.9	3.0	3.0	3.0	2.9	3.0	3.0	3.0	3.0	3.0	2.94	2.92	2.89	2.78	2.77	2.75	2.72	2.71	2.71	
Diesel																						
CO ₂	t/TJ	73.6	73.6	73.6	73.6	73.6	73.6	73.6	73.6	73.6	73.6	73.6	73.6	73.6	73.6	73.6	73.6	73.6	73.6	73.6	73.6	
CH ₄	kg/TJ	1.8	1.8	1.8	1.7	1.7	1.6	1.5	1.5	1.4	1.3	1.2	1.1	0.9	0.9	0.8	0.7	0.6	0.55	0.45	0.40	
N ₂ O	kg/TJ	0.5	0.5	0.5	0.5	0.5	0.5	0.5	0.5	0.5	0.5	0.5	0.49	0.49	0.49	0.51	0.54	0.57	0.60	0.70	0.68	
Gaseous fuels																						
CO ₂	t/TJ	NO	NO	NO	NO	NO	NO	NO	NO	NO	NO	NO	55.0	55.0	55.0	55.0	55.0	55.0	55.0	55.0	55.0	
CH ₄	kg/TJ	NO	NO	NO	NO	NO	NO	NO	NO	NO	NO	NO	50.0	50.0	50.0	50.0	50.0	50.0	50.0	50.0	50.0	
N ₂ O	kg/TJ	NO	NO	NO	NO	NO	NO	NO	NO	NO	NO	NO	0.10	0.10	0.10	0.10	0.10	0.10	0.10	0.10	0.10	
Biofuel																						
CO ₂	t/TJ	NO	NO	NO	NO	NO	NO	NO	NO	NO	NO	NO	NO	NO	NO	NO	NO	NO	NO	73.6	73.6	73.6
CH ₄	kg/TJ	NO	NO	NO	NO	NO	NO	NO	NO	NO	NO	NO	NO	NO	NO	NO	NO	NO	NO	0.55	0.45	0.40
N ₂ O	kg/TJ	NO	NO	NO	NO	NO	NO	NO	NO	NO	NO	NO	NO	NO	NO	NO	NO	NO	NO	0.60	0.70	0.68

Gas	unit	2010	2011
Gasoline			
CO ₂	t/TJ	73.9	73.9
CH ₄	kg/TJ	8.07	8.07
N ₂ O	kg/TJ	2.72	2.72
Diesel			
CO ₂	t/TJ	73.6	73.6
CH ₄	kg/TJ	0.37	0.37
N ₂ O	kg/TJ	0.70	0.70
Gaseous fuels			
CO ₂	t/TJ	55.0	55.0
CH ₄	kg/TJ	50.0	50.0
N ₂ O	kg/TJ	0.10	0.10
Biofuel			
CO ₂	t/TJ	NO	NO
CH ₄	kg/TJ	NO	NO
N ₂ O	kg/TJ	NO	NO

The following paragraph gives a couple of explanations to the origin of the Swiss emission factors for road transportation. As described here, a model by INFRAS (2010) was implemented for the present submission:

Swiss emission factors (excerpt from NIR CH, chpt. 3.2.8.2.b, FOEN 2012):

“The emission factors for fossil CO₂ and other gases are country specific and based on measurements and analyses of fuel samples (see Table 3-3). Emission factors for the further gases are country specific derived from “emission functions” which are determined from a compilation of measurements from various European countries with programs using similar driving cycles (legislative as well as standardized real-world cycles, like “Common Artemis Driving Cycle” (CADC). The method has been developed in 1990-1995 and has been extended and updated in 2000, 2004 and 2010. These emission factors are compiled in a so called “Handbook of Emission Factors for Road Transport” (SAEFL 1995, 2004, 2004a, FOEN 2010, INFRAS 2004, 2004a, 2010). The latest version (3.1) is presented and documented on the website <http://www.hbefa.net/>. Several reports may be downloaded from there:

- *Documentation of the general emission factor methodology (INFRAS 2011; forthcoming in German),*

- *Emission Factors for Passenger Cars and Light Duty Vehicles Switzerland, Germany, Austria, Norway and Sweden (INFRAS 2010; in English),*

The resulting emission factors are published on CD ROM (“Handbook of emission factors for Road Transport”, INFRAS 2010). The underlying database contains a dynamic fleet compositions model simulating the release of new exhaust technologies and the fading out of old technologies. Corrective factors are provided to account for future technologies. Further details are shown in Annex A3.1.4 of FOEN 2011.

The CO₂ factors are constant over the whole period 1990–2009. The carbon content of the fuels has not changed. However, the increasing portion of biofuels to the fuels is encompassed by the data time series. For the other gases, more or less pronounced decreases of the emission factors occur due to new emission regulations and subsequent new exhaust technologies (mandatory use of catalytic converters for gasoline cars and lower limits for sulphur content in diesel fuels). Early models of catalytic converters have been substantial sources of N₂O, leading to an emission increase until 1998. Recent converter technologies have overcome this problem resulting in a decrease of the (mean) emission factor. The N₂O emission factors vary between 1 and 4 kg/TJ for gasoline, and between 0.5 and 2 kg/TJ, which is higher than the IPCC default values (0.6 kg/TJ). The factors newly used in Switzerland are taken from Coppert 4 model (EEA 2010). Note that the newly used emission factors are higher than the ones used until the previous submission. In contrast to the N₂O emission factors, the measurement sample for CH₄ emission factors remained the same. However, due to updates in the vehicles fleet composition, the implied emission factors changed eventually.”

It may be added that cold start and evaporative emissions are included in the Swiss modelling scheme.

Activity Data

The amount of gasoline and diesel fuel sold in Liechtenstein serves as the activity data for the calculation of the CO₂ emissions. For diesel, 86.4% of the value for “diesel” in the national statistics of Table 3-4 is consumed in 1A3b Road Transportation, the remaining amount in 1A5b (construction) and 1A4c Other Sectors, agricultural machinery (see also Table 3-30). For gaseous fuels, the amount reported by gasoline stations is used. There is no biofuel production in Liechtenstein anymore.

Table 3-25 Activity data for 1A3b Road Transportation.

Fuel	1990	1991	1992	1993	1994	1995	1996	1997	1998	1999
	TJ									
Gasoline	819	916	957	947	878	903	909	954	896	940
Diesel	201	282	231	211	182	184	195	199	253	287
Natural Gas	0	0	0	0	0	0	0	0	0	0
Biofuel	0	0	0	0	0	0	0	0	0	0
Sum	1'020	1'198	1'188	1'159	1'060	1'087	1'104	1'152	1'149	1'226
	100%	118%	116%	114%	104%	107%	108%	113%	113%	120%

Fuel	2000	2001	2002	2003	2004	2005	2006	2007	2008	2009
	TJ									
Gasoline	1'040	1'007	920	879	851	823	752	756	760	699
Diesel	240	214	229	264	277	298	326	369	420	397
Natural Gas	0	14	31	32	31	32	36	49	54	55
Biofuel	0	0	0	0	0	0	0	1	1	0
Sum	1'279	1'235	1'179	1'175	1'159	1'153	1'114	1'175	1'235	1'152
	125%	121%	116%	115%	114%	113%	109%	115%	121%	113%

Fuel	2010	2011
	TJ	
Gasoline	631	600
Diesel	403	424
Natural Gas	59	57
Biofuel	0	0
Sum	1'093	1'080
	107%	106%

The share of gasoline has decreased from 80.3% in 1990 to 55.5% in 2011. In the same period, the consumption of diesel has increased from 19.7% to 39.2%, natural gas from 0% to 5.2%. The consumption of biofuel has only started in 2007 and stopped in 2010, due to a halt of production.

In the study OEP (2002) the territorial fuel consumption was estimated based on kilometres travelled. This approach is substantiated by a model which uses input data from transport statistics and traffic counting. The CO₂ emissions were more than 40% lower in the base year and 30% lower in 2004 than the emissions reported in respective GHG inventories. The differences between this result and the statistics of fuel sales are explained by fuelling of Austrian cars due to lower gasoline prices in Liechtenstein. Moreover, the differences show the importance of collecting sales numbers as activity data for Liechtenstein and not using data derived from the territorial principle.

c) Railways (1A3c)

There is a railway line crossing the country, where Austrian and Swiss railways are passing. Liechtenstein has no own railway. The railway line is owned and maintained by the Austrian Federal Railway. The line in Liechtenstein is fully electrified. There are no diesel sales to railway locomotives, therefore there are no emissions occurring, which are relevant for the GHG inventory.

d) Navigation (1A3d)

Navigation is not occurring in Liechtenstein, because there are no lakes, and the river Rhine is not navigable on the territory of Liechtenstein. Therefore, no emissions are occurring for this sector.

3.2.6.9 Methodological Issues: Other Sectors (Commercial, Residential, Agriculture, Forestry; 1A4)**a) Commercial/ Institutional (1A4a) and Residential (1A4b)***Methodology*

For Fuel Combustion in Commercial and Institutional Buildings (1A4a) and in Households (1A4b), a Tier 2 method is used and cross-checked with the country specific estimate on the gas oil consumption based on expert judgement (see sub-section 3.1.3.2a). A top-down method based on aggregated fuel consumption data from the energy statistics of Liechtenstein (OS 2012a) is used to calculate emissions.

These sources are characterised by rather similar combustion processes and therefore, the same emission factors are assumed for 1A4a and 1A4b.

An oxidation factor of 100% is assumed for all combustion processes and fuels (see sub-section 3.2.1.1).

Emissions of GHG are calculated by multiplying levels of activity by emission factors.

Emission Factors

The emission factors for CO₂ are country specific and are based on measurements and analysis of fuel samples carried out by the Swiss Federal Laboratories for Materials Testing and Research EMPA (carbon emission factor documented in SFOE 2001, Table 45, p. 51; net calorific values on p. 61. See also Annex A2.1).

The coal emission factor for CO₂ refers to the emission factor of hard coal in Switzerland (FOEN 2012), where similar conditions prevail. As Liechtenstein is a small neighbouring country of Switzerland, it is assumed that similar coal is used as in Switzerland.

Emission factors for CH₄ are country specific and are based on comprehensive life cycle analysis of combustion boilers in the residential, commercial institutional and agricultural sectors, documented in SAEFL 2000a (pp. 42-56) and SAEFL 2005. For the N₂O emissions the default emission factors from IPCC 1997c have been used.

The country specific emission factor for CH₄ emissions from Liquefied Petroleum Gas (LPG) is from UBA 2004.

All emission factors for biomass are country specific and are based on SAEFL 2000a (pp. 26ff).

The emission factors for alkylate gasoline are the same as for gasoline, as reported in chapter 3.2.6.8.

Since the fraction of stationary engines in total fuel consumption is rather small, emission factors for combustion boilers are used for all sources and fuels considered.

Table 3-26 presents the emission factors used in 1A4a and 1A4b:

Table 3-26 Emission Factors for 1A4a and 1A4b: Commercial/Institutional and Residential in “Other Sectors” for the year 2011. All emission factors except those for alkylate gasoline are constant for the years 1990 - 2011. Emission factors for alkylate gasoline are the same as for gasoline, as reported in chapter chapter 3.2.6.8.

Source/fuel	CO ₂ t/TJ	CO ₂ bio. t/TJ	CH ₄ kg/TJ	N ₂ O kg/TJ
1A4 a/b Other Sectors: Commercial/Institutional and Residential				
Gas oil	73.7		1.01	0.6
LPG	65.5		2.5	0.1
Alkylate gasoline	73.9		8.07	2.72
Coal	94.0		300	1.6
Natural gas	55.0		6	0.38
Biomass (1A4a)		92	8	1.6
Biomass (1A4b) ⁷		92	350	1.6

Activity Data

Activity data on fuel consumption (TJ) are based on aggregated fuel consumption data from the energy statistics of Liechtenstein (OS 2012a). A description of the modifications and the disaggregation of data from energy statistics is provided in Section 3.1.3.

The resulting disaggregated fuel consumption data from 1990–2011 is provided in Table 3-27.

Activity data for consumption of alkylate gasoline have been determined by a census carried out by OEP (OEP 2012b) (see also 3.1.3.2). 20% of alkylate gasoline is allocated to households and reported in 1A4b Residential, and 80% of alkylate gasoline is allocated to Agriculture and Forestry and reported in 1A4c.

⁷ The CH₄ emission factor of 350 kg/TJ in 1A4b Residential is an average value over emission factors for open fireplaces (700 kg/TJ), old closed stoves (450 kg/TJ), modern closed stoves (130 kg/TJ), and modern closed stoves with ventilation (70 kg/TJ).

Table 3-27 Activity data in 1A4a Commercial/Institutional and 1A4b Residential.

Source/Fuel	Unit	1990	1991	1992	1993	1994	1995	1996	1997	1998	1999
1A4a Commercial/Institutional	TJ	961	892	893	979	943	933	942	1'005	1'100	1'020
Gas oil	TJ	763	669	646	713	657	639	593	675	725	636
LPG	TJ	13.3	8.1	15.5	12.1	9.5	8.1	9.8	7.0	7.2	5.8
Natural gas	TJ	158	196	204	229	246	264	319	298	340	347
Coal	TJ	NO	NO	NO	NO	NO	NO	NO	NO	NO	NO
Biomass	TJ	27	19	27	24	31	23	21	25	29	31
1A4b Residential	TJ	319	319	354	401	390	416	434	467	510	522
Gas oil	TJ	254	223	215	238	219	213	198	225	242	212
Alkylate gasoline	TJ	0.0	0.0	0.0	0.0	0.0	0.1	0.1	0.1	0.1	0.1
Natural gas	TJ	46	82	120	146	150	188	222	224	248	289
Coal	TJ	1.0	0.9	1.1	1.0	0.7	0.7	0.5	0.5	0.6	0.3
Biomass	TJ	18	12	18	16	20	15	14	17	19	21

Source/Fuel	Unit	2000	2001	2002	2003	2004	2005	2006	2007	2008	2009
1A4a Commercial/Institutional	TJ	976	963	1'057	1'123	1'151	1'168	1'219	955	1'071	1'038
Gas oil	TJ	558	531	601	637	618	591	616	365	466	524
LPG	TJ	5.5	3.9	4.2	4.6	4.1	3.7	5.5	6.1	4.7	4.8
Natural gas	TJ	357	394	417	435	478	516	533	498	514	404
Coal	TJ	NO	NO	NO	NO	NO	NO	NO	NO	NO	NO
Biomass	TJ	55	34	35	46	51	56	64	86	86	106
1A4b Residential	TJ	513	533	565	612	647	667	680	589	647	676
Gas oil	TJ	186	177	200	212	206	197	205	122	155	175
Alkylate gasoline	TJ	0.1	0.1	0.1	0.1	0.1	0.1	0.1	0.1	0.1	0.2
Natural gas	TJ	290	334	341	369	407	432	431	410	434	431
Coal	TJ	0.6	0.3	0.3	0.3	0.3	0.2	0.2	0.1	0.1	0.1
Biomass	TJ	37	22	23	31	34	38	43	57	58	70

Source/Fuel	Unit	2010	2011
1A4a Commercial/Institutional	TJ	922	841
Gas oil	TJ	417	365
LPG	TJ	5.3	4.2
Natural gas	TJ	386	349
Coal	TJ	NO	NO
Biomass	TJ	114	124
1A4b Residential	TJ	692	618
Gas oil	TJ	139	122
Alkylate gasoline	TJ	0.2	0.2
Natural gas	TJ	477	414
Coal	TJ	0.1	0.1
Biomass	TJ	76	82

The table above documents the increase of natural gas consumption by a factor of more than two (1A4a) and by a factor of nine (1A4b) from 1990 to 2011 based on the build-up of Liechtenstein's gas supply network.

Gas oil consumption decreased by 52% in both categories 1A4a and 1A4b over the same period. The significant decrease of 2007, followed again by an increase of gas oil consumption between 2008 and 2009 and a decrease in 2010 and 2011, is due to two reasons, as explained in chapter 2.3:

- fluctuation of prices of fossil fuels
- warm winters

As stock changes in residential fuel tanks are not taken into account, high prices of fossil fuels therefore led to a smaller apparent consumption of fossil fuels 2007, when stocks were depleted, and higher apparent consumption in 2008, when fuel tanks were refilled. In 2009, the lower prices raised the demand of gas oil and the launch of the CO₂-Tax on 1.1.2010 induced the commercial consumers to refill their fuel tanks at the end of 2009.

This shift in fuel mix is the reason for CO₂ emissions from the use of gaseous and liquid fuels in category 1A4a and 1A4b being key categories regarding level and trend.

b) Agriculture/Forestry (1A4c)*Methodology*

For source category 1A4c, a Tier 1 method is used. Emissions stem from fuel combustion in agricultural machinery. Implied emission factors from a Swiss off-road study (INFRAS 2008) are used. The activity data is derived from the information provided by the General Directorate of Swiss Customs (refunding institution of fuel levies until 2005) and by OEP census (OEP 2012c). For details, see above in 3.1.3a), paragraph Gasoline/Diesel oil.

Emission Factors

Emission factors for the use of diesel in off-road machinery are country specific and are taken from INFRAS 2008 (diesel engines). Emission factors for alkylate gasoline are shown in Table 3-26.

Activity Data

Off-road machinery: Activity data is shown in Table 3-28. Besides diesel, the consumption of alkylate gasoline is also accounted for (20% in 1A4b and 80% in 1A4c). The consumption of alkylate fuels in 2011 has been derived from the first detailed census carried out by OEP (OEP 2012c). As a consequence, emissions 2000-2010 were recalculated based on linear interpolation of alkylate fuel consumption data between 2000 and 2011, since otherwise an increase of 44% would have resulted between 2010 and 2011.

Table 3-28 Activity data in 1A4c Agriculture/Forestry.

Fuel	1990	1991	1992	1993	1994	1995	1996	1997	1998	1999
	TJ									
Alkylate Gasoline	0.0	0.0	0.0	0.0	0.0	0.2	0.4	0.4	0.4	0.4
Diesel	18	18	18	17	17	17	16	18	17	19

Fuel	2000	2001	2002	2003	2004	2005	2006	2007	2008	2009
	TJ									
Alkylate Gasoline	0.4	0.5	0.5	0.5	0.5	0.6	0.6	0.6	0.7	0.7
Diesel	18	18	18	20	20	18	19	20	19	19

Fuel	2010	2011
	TJ	
Alkylate Gasoline	0.7	0.7
Diesel	19	14

c) Other – Off-road: Construction and Industry (1A5b)*Methodology*

For source category 1A5, a Tier 1 method is used. According to Table 3-9, among private diesel tanks non-agriculture, the amount of 30% of the consumption is attributed to 1A5b Other/Mobile (off-road) activity: Construction vehicles and machinery; Industrial off-road vehicles and machinery. Emission factors are taken from the most recent Swiss off-road study (INFRAS 2008).

Emission Factors

The emission factors are country specific and are based on a query on the Swiss off-road database for construction machinery (INFRAS 2008). They correspond to implied emission factors: The total of emissions of the whole fleet of construction vehicles was divided by the fuel consumption (in TJ). For the application in the Liechtenstein inventory, it is assumed, that the fleet composition is similar to the Swiss fleet composition (vehicle category, size class, age distribution).

Table 3-29 Emission factors used for 1A5b Other – Off-road / mobile sources. Data are based on revised Swiss off-road database (INFRAS 2008).

Gas	unit	1990	1991	1992	1993	1994	1995	1996	1997	1998	1999
liquid fuels											
CO ₂	t/TJ	73.6	73.6	73.6	73.6	73.6	73.6	73.6	73.6	73.6	73.6
CH ₄	kg/TJ	0.72	0.73	0.73	0.73	0.73	0.74	0.73	0.73	0.73	0.73
N ₂ O	kg/TJ	2.98	2.99	2.99	2.99	2.99	2.99	2.99	2.99	2.99	2.99

Gas	unit	2000	2001	2002	2003	2004	2005	2006	2007	2008	2009
liquid fuels											
CO ₂	t/TJ	73.6	73.6	73.6	73.6	73.6	73.6	73.6	73.6	73.6	73.6
CH ₄	kg/TJ	0.72	0.72	0.72	0.72	0.72	0.72	0.72	0.72	0.72	0.71
N ₂ O	kg/TJ	2.99	2.99	2.99	2.99	2.98	2.98	2.97	2.97	2.97	2.96

Gas	unit	2010	2011
liquid fuels			
CO ₂	t/TJ	73.6	73.6
CH ₄	kg/TJ	0.71	0.71
N ₂ O	kg/TJ	2.96	2.95

Activity Data

The activity data includes the consumption of diesel oil as mentioned in the paragraph “Methodology” above and Section 3.1.3.1, paragraph Gasoline/Diesel oil.

Table 3-30 Activity data (diesel oil consumption) for 1A5b Other – Off-road / mobile sources.

Fuel	1990	1991	1992	1993	1994	1995	1996	1997	1998	1999
	TJ									
Diesel	32.1	38.8	39.6	32.7	30.7	29.7	30.4	34.3	39.8	42.1

Fuel	2000	2001	2002	2003	2004	2005	2006	2007	2008	2009
	TJ									
Diesel	40.3	34.4	37.2	46.3	41.1	47.5	49.2	45.3	48.3	49.1

Fuel	2010	2011
	TJ	
Diesel	47.1	53.3

3.2.6.10 Uncertainties and Time-Series Consistency

a) Uncertainties

Uncertainty in aggregated fuel consumption activity data (1A Fuel Combustion)

Liechtenstein and Switzerland form a customs and monetary union governed by a customs treaty. Therefore, no customs statistics exist that would provide reliable data on (liquid and solid) fuels imports into Liechtenstein.

The level of disaggregation that has been chosen for the key category analysis provides a rather fine disaggregation of combustion related CO₂ emissions in Sector 1 Energy. E.g. the key category analysis distinguishes between emissions from Commercial/Institutional (1A4a), Residential (1A4b), and Agriculture/Forestry (1A4c).

However, the data on fuel consumption originates at the aggregated level of sales data. It is only later disaggregated using simple expert judgement leading to the consumption in different branches (see Section 3.1.3). The analysis of uncertainties for CO₂ emissions from fuel combustion is carried out on the level of aggregated total national emissions (1A) for gaseous, liquid and solid fuels. This to avoid errors that are introduced in the process of disaggregation, but do not apply to the aggregated emissions on the national level. For liquid fuels, the uncertainties have been estimated for four fuel types separately, because methods to determine fuel consumption and associated uncertainties differ for each fuel type (see also Sect. 1.7.1.3 and Sect. 3.1.3).

Details of uncertainty analysis of activity data (fuel consumption) in 1A are based on expert judgements. The dominant contributor to overall uncertainty is liquid fuel consumption. Because customs statistics of imports of oil products do not exist, this data is based on surveys with oil suppliers carried out earlier by OEA and in recent years by OEP. The methodology and completeness of the surveys has been improved over the years. Therefore it is assumed that the uncertainty in activity data for liquid fuels around 1990 is rather high, whereas recent data is of medium uncertainty.

Comparing the different liquid fuels, the uncertainty for gasoline is lowest, because activity data is based on surveys at all filling stations in Liechtenstein and the uncertainty is estimated to be 10%. Diesel consumption is also based on surveys at filling stations, but small unknown quantities may be imported directly from construction companies and farmers, and uncertainty is estimated to be 15%. The uncertainty for gas oil and LPG consumption is estimated to be the highest among liquid fuels, because fuel is provided by direct delivery to homes by several companies, which is more difficult to monitor, and uncertainty is estimated to be 20%. Uncertainty for jet kerosene is estimated to be 15%. The total of kerosene reported may be known more precisely, but the split into domestic and international is quite uncertain.

Uncertainty in CO₂ emission factors in fuel combustion (1A)

Liechtenstein and Switzerland form a customs and monetary union governed by a customs treaty. Therefore, all gas oil is supplied by Swiss suppliers and no taxation accrues at the borders for the import to Liechtenstein. It may therefore be assumed that fuel has the same properties as the fuels sold on the Swiss market. Therefore, the emission factors and their uncertainties have been taken from Switzerland, and are documented in the Swiss NIR (FOEN 2012).

Table 3-31 provides the results of the quantitative Tier 1 analysis (following Good Practice Guidance; IPCC 2000, p.6.13ff) estimating uncertainties of CO₂ emissions from fuel combustion activities.

Table 3-31 Results from Tier 1 uncertainty calculation and reporting for CO₂ emissions in 1A Fuel Combustion.

IPCC GPG Table 6.1
Tier 1 Uncertainty Calculation and Reporting

A	B	C	D	E	F	G	H	I	J	K	L	M		
IPCC Source category	Gas	Base year emissions 1990	Year 2011 emissions	Activity data uncertainty	Emission factor uncertainty	Combined uncertainty	Combined uncertainty as % of total national emission in year t	Type A sensitivity	Type B sensitivity	Uncertainty in trend in national emissions introduced by emission factor uncertainty	Uncertainty in trend in national emissions introduced by activity data uncertainty	Uncertainty introduced into the trend in total national emissions		
	Input data	Input data	Input data	Input data	Calc/Input									
	Gg CO ₂ eq	Gg CO ₂ eq	%	%	%	%	%	%	%	%	%	%		
Total Uncertainty Energy		201.53	184.04				4.96					6.33		
1A1 1. Energy A. Fuel Combustion	1. Energy Industries	Gaseous Fuels	CO2	0.12	2.89	5.0	4.60	6.8	0.107	0.0138	0.0143	0.06	0.10	0.12
1A1 1. Energy A. Fuel Combustion	1. Energy Industries	Liquid Fuels	CO2	0.00	0.00	0.0	0.00	0.0	0.000	0.0000	0.0000	0.00	0.00	0.00
1A1 1. Energy A. Fuel Combustion	1. Energy Industries	Other Fuels	CO2	0.00	0.00	0.0	0.00	0.0	0.000	0.0000	0.0000	0.00	0.00	0.00
1A1 1. Energy A. Fuel Combustion	1. Energy Industries	Solid Fuels	CO2	0.00	0.00	0.0	0.00	0.0	0.000	0.0000	0.0000	0.00	0.00	0.00
1A2 1. Energy A. Fuel Combustion	2. Manufacturing Industries and Con	Liquid Fuels	CO2	18.74	8.96	20.0	0.50	20.0	0.974	-0.0404	0.0445	-0.02	1.26	1.26
1A2 1. Energy A. Fuel Combustion	2. Manufacturing Industries and Con	Gaseous Fuels	CO2	16.48	10.35	5.0	4.60	6.8	0.382	-0.0233	0.0514	-0.11	0.36	0.38
1A2 1. Energy A. Fuel Combustion	2. Manufacturing Industries and Con	Solid Fuels	CO2	0.00	0.00	0.0	0.00	0.0	0.000	0.0000	0.0000	0.00	0.00	0.00
1A2 1. Energy A. Fuel Combustion	2. Manufacturing Industries and Con	Other Fuels	CO2	0.00	0.00	0.0	0.00	0.0	0.000	0.0000	0.0000	0.00	0.00	0.00
1A3a 1. Energy A. Fuel Combustion	3. Transport; Civil Aviation		CO2	0.08	0.15	15.0	1.20	15.0	0.012	0.0004	0.0007	0.00	0.02	0.02
1A3b 1. Energy A. Fuel Combustion	3. Transport; Road Transportation	Gaseous Fuels	CO2	0.00	3.11	5.0	4.60	6.8	0.115	0.0154	0.0154	0.07	0.11	0.13
1A3b 1. Energy A. Fuel Combustion	3. Transport; Road Transportation	Diesel	CO2	14.77	31.17	15.0	0.50	15.0	2.542	0.0877	0.1547	0.04	3.28	3.28
1A3b 1. Energy A. Fuel Combustion	3. Transport; Road Transportation	Gasoline	CO2	60.53	44.33	10.0	1.40	10.1	2.432	-0.0541	0.2200	-0.08	3.11	3.11
1A3e 1. Energy A. Fuel Combustion	3. Transport; Other Transportation (military aviation)		CO2	0.00	0.00	0.0	0.00	0.0	0.000	0.0000	0.0000	0.00	0.00	0.00
1A4a 1. Energy A. Fuel Combustion	4. Other Sectors; Commercial/Institu	Liquid Fuels	CO2	57.10	27.15	20.0	0.50	20.0	2.952	-0.1236	0.1347	-0.06	3.81	3.81
1A4a 1. Energy A. Fuel Combustion	4. Other Sectors; Commercial/Institu	Gaseous Fuels	CO2	8.70	19.17	5.0	4.60	6.8	0.708	0.0557	0.0951	0.26	0.67	0.72
1A4a 1. Energy A. Fuel Combustion	4. Other Sectors; Commercial/Institu	Solid Fuels	CO2	0.00	0.00	0.0	0.00	0.0	0.000	-0.0000	0.0000	0.00	0.00	0.00
1A4b 1. Energy A. Fuel Combustion	4. Other Sectors; Residential	Solid Fuels	CO2	0.09	0.00	20.0	5.00	20.6	0.001	-0.0004	0.0000	0.00	0.00	0.00
1A4b 1. Energy A. Fuel Combustion	4. Other Sectors; Residential	Gaseous Fuels	CO2	2.51	22.78	5.0	4.60	6.8	0.841	0.1017	0.1131	0.47	0.80	0.93
1A4b 1. Energy A. Fuel Combustion	4. Other Sectors; Residential	Liquid Fuels	CO2	18.74	8.97	20.0	0.50	20.0	0.975	-0.0404	0.0445	-0.02	1.26	1.26
1A4c 1. Energy A. Fuel Combustion	4. Other Sectors; Agriculture/Forestr	Liquid Fuels	CO2	1.30	1.07	20.0	0.50	20.0	0.117	-0.0006	0.0053	0.00	0.15	0.15
1A4c 1. Energy A. Fuel Combustion	4. Other Sectors; Agriculture/Forestr	Gaseous Fuels	CO2	0.00	0.00	0.0	0.00	0.0	0.000	0.0000	0.0000	0.00	0.00	0.00
1A5 1. Energy A. Fuel Combustion	5. Other	Liquid Fuels	CO2	2.36	3.92	20.0	0.50	20.0	0.426	0.0087	0.0194	0.00	0.55	0.55

Qualitative estimate of uncertainties of non-key category emissions in 1A Fuel Combustion

Non-CO₂ emissions in Energy Industries (1A1), Manufacturing Industries and Construction (1A2) and Other Sectors (Commercial, Residential, Agriculture, Forestry; 1A4):
Uncertainty in emissions of non-CO₂ gases is estimated to be medium.

Non-CO₂ emissions in 1A3 and 1A5:
Uncertainty in emissions of non-CO₂ gases is estimated to be high.

b) Consistency and Completeness in 1A Fuel Combustion

Consistency:

The method for the calculation of GHG emissions is the same for the years 1990 to 2011; time series is consistent.

Completeness:

The emissions for the full time series 1990–2011 have been calculated and reported. The data on emissions of the six Kyoto gases (CO₂, CH₄, N₂O, HFC, PFC, SF₆) are therefore complete.

3.2.6.11 Source-Specific QA/QC and Verification

The source-specific QA/QC activities have been carried out as mentioned in sections 1.6.1.4 and 1.6.1.5 including also the triple check of the CRF tables. This includes the detailed comparison of the data of the current with previous submission for the base year, for 2010 and for the changing rates 2010/2011. They are documented in the checklist in Annex 8. Special attention has been focused on the update of the activity data as for example on the energy sales data. They were checked independently by two NIR authors and by the OEP specialist. In addition, the activity data has been counter-checked with the data in the Energy Statistics of Liechtenstein as well as with the annual report of the Gasdistribution Liechtenstein (LGV).

Road Transportation (1A3b)

The international project for the update of the emission factors for road vehicles is overseen by a group of external and international experts that guarantees an independent quality control. For the update of the modelling of Switzerland's road transport emissions, which has been carried out between 2008 and 2010 and which is also used for Liechtenstein, several experts from the federal administration have conducted the project. The results have undergone large plausibility checks and comparisons with earlier estimates.

The emission factors for CH₄ and N₂O used for the modelling of 1A3b Road Transportation are taken from the handbook of emission factors (INFRAS 2010), which is also applied in Germany, Austria, Netherlands and Sweden. The Swiss emission factors for CH₄ and N₂O used in 1A3b were additionally compared with those depicted in the CRF from Germany and a high consistency was found. Possible small differences might result from a varying fleet composition.

3.2.6.12 Source-Specific Recalculations (incl. changes due to review)

1A3b: The N₂O emission factors for diesel and petrol were updated based on the new Swiss emission factors (FOEN 2012), which affects the time series from 1991 to 2009. For 2010, CH₄ and N₂O emission factors were updated based on the Swiss submission (FOEN 2012).

1A4b/1A4c: Based on a first detailed census of alkylate gasoline consumption a more reliable consumption figure for 2011 was available; consequently the time series from 2001 to 2010 was linearly interpolated since otherwise a 44% increase from 2010 to 2011 would have resulted. This affected CO₂, CH₄ and N₂O emissions. Furthermore, the consumption figure for liquid gas for 2010 was corrected by the Office of Statistics from 87 t to 116 t, which affected CO₂, CH₄ and N₂O emissions for 2010.

1A4a: LPG consumption of 2010 has been updated based on updated information on consumption from the national energy statistics of Liechtenstein.

3.2.6.13 Source-Specific Planned Improvements

No planned improvements.

3.3 Source Category 1B – Fugitive Emissions from Fuels and Oil and Natural Gas

3.3.1 Source Category

3.3.1.1 Source Category Description

Source category 1B "Fugitive Emissions from Fuels" is **not a key category**.

Fugitive emissions arise from the production, processing, transmission, storage and use of fuels. According to IPCC guidelines, emissions from flaring at oil and gas production facilities are included while emissions from vehicles are not included in 1B.

Source Category 1B "Fugitive Emissions from Fuels" comprises the following source categories: Solid fuels (1B1) and Oil and Natural Gas (1B2).

a) Solid fuels (1B1)

Coal mining is not occurring in Liechtenstein.

b) Oil and Natural Gas (1B2)

Table 3-32 Specification of source category 1B2 "Fugitive Emissions from Oil and Natural Gas" (AD: activity data; EF: emission factors)

1B2	Source	Specification	Data Source
1B2 a	Oil	Refining of oil is not occurring	-
1B2 b	Natural Gas	Emissions from gas pipelines	AD: LGV 2012 EF: FOEN 2012
1B2 c	Venting / Flaring	Not occurring	-

3.3.2 Methodological Issues

a) Oil and Natural Gas (1B2)

Methodology

For source 1B2b Natural Gas, the emissions of CH₄ leakages from gas pipelines are calculated with a Tier 3 method, adapted from the Swiss NIR (FOEN 2012). The method considers the length, type and pressure of the gas pipelines. The distribution network components (regulators, shut off fittings and gas meters), the losses from maintenance and extension as well as the end user losses are taken into account. NMVOC leakages are not estimated.

The current 1B2 methane emission calculation is based on data on natural gas quality from Switzerland (FOEN 2012). *Emission factors*

The emission factors for gas distribution losses (source 1B2b) depend on the type and pressure of the natural gas pipeline (see Table 3-33; sources cited in FOEN 2012, Battelle 1994, Xinmin 2004). The CH₄-emissions due to gas meters are considered with an emission factor of 5.11m³CH₄ per gas meter and year.

Table 3-33 CH₄-Emission Factors for 1B2 "Fugitive Emissions from Oil and Natural Gas" in 2011 (Battelle 1994, Xinmin 2004). For HDPE (Polyethylene) 1-5 bar, the first value shows the assumption for 1993 and previous years while the second value (in brackets) shows the value for 2001 and following years. Data between 1993 and 2001 are linearly interpolated between the two values.

1B2 Fugitive Emissions from Oil and Natural Gas	< 100 mbar [m ³ /h/km]	1- 5 bar [m ³ /h/km]	> 5 bar [m ³ /h/km]
Steel cath.	-	-	0.0284
HDPE (Polyethylene)	0.0080	0.0024 (0.00062)	-

Activity data

The activity data such as length and type of pipes in the distribution network for the calculation of methane leaks have been extracted from the annual reports of Liechtenstein's Gas Utility (LGV 2012).

As recommended in the last inventory review, the emissions are now divided in the activity data of the Steel cath. Pipeline of > 5 bar as part of the transmission and the distribution network of the HDPE pipelines.

Table 3-34 Activity Data for 1B2 "Fugitive Emissions from Oil and Natural Gas": length of pipes and number of connections to customers

Source/Fuel	Unit	1990	1991	1992	1993	1994	1995	1996	1997	1998	1999
1B2 Fugitive Emissions from Oil and Natural Gas											
Steel cath. > 5 bar	km	26.3	26.3	26.3	26.3	26.3	26.3	26.3	26.3	26.3	26.3
HDPE (Polyethylene) < 100 mbar	km	67.0	84.3	96.5	109.0	122.4	135.9	147.6	162.7	179.3	192.0
HDPE (Polyethylene) 1-5 bar	km	28.5	28.5	28.3	28.5	29.2	29.5	29.8	30.0	34.1	35.8
Connections	No.	479	698	890	1'060	1'221	1'398	1'584	1'782	1'984	2'195

Source/Fuel	Unit	2000	2001	2002	2003	2004	2005	2006	2007	2008	2009
1B2 Fugitive Emissions from Oil and Natural Gas											
Steel cath. > 5 bar	km	26.3	26.3	26.6	26.6	26.6	26.6	26.6	26.6	26.6	26.6
HDPE (Polyethylene) < 100 mbar	km	206.0	218.7	238.5	252.0	264.9	276.3	289.1	297.6	304.6	308.6
HDPE (Polyethylene) 1-5 bar	km	37.3	37.4	36.0	38.9	45.3	45.6	49.3	49.7	50.1	50.8
Connections	No.	2'460	2'657	2'863	3'067	3'271	3'464	3'659	3'801	3'948	4'045

Source/Fuel	Unit	2010	2011
1B2 Fugitive Emissions from Oil and Natural Gas			
Steel cath. > 5 bar	km	26.6	26.6
HDPE (Polyethylene) < 100 mbar	km	312.8	319.3
HDPE (Polyethylene) 1-5 bar	km	51.0	51.5
Connections	No.	4'116	4'209

The table above documents the continuous increase of Liechtenstein's gas supply network since 1990. The number of connections installed have increased by more than factor 8 compared to those from 1990 to 2011.

3.3.3 Uncertainties and Time-Series Consistency

Uncertainty in fugitive CH₄ emissions from natural gas pipelines in 1B2

Following Good Practice Guidance (IPCC 2000: p.2.92) overall uncertainty of bottom-up inventories of fugitive methane losses from gas activities are expected to result in errors of 25-50%. From this a conservative uncertainty of 50% is estimated for Liechtenstein.

The time series is consistent.

3.3.4 Source-Specific QA/QC and Verification

The source-specific QA/QC activities have been carried out as mentioned in sections 1.6.1.4 and 1.6.1.5 including also the triple check of the CRF tables (detailed comparison of latest with previous data for the base year, for 2010 and for the changing rates 2010/2011).

3.3.5 Source-Specific Recalculations

No recalculations have been carried out since the Saturday Paper of Autumn 2012.

3.3.6 Source-Specific Planned Improvements

No planned improvements are foreseen for the next submission.

4 Industrial Processes

4.1 Overview

According to IPCC guidelines, emissions within this sector comprise greenhouse gas emissions as by-products from industrial processes and also emissions of synthetic greenhouse gases during production, use and disposal. Emissions from fuel combustion in industry are reported under sector 1 Energy.

Only few IPCC source categories among the sector Industrial Processes occur in Liechtenstein. Sources in the categories 2B, 2C, 2D, 2E and 2G are not occurring at all. Emissions are reported from categories 2A Mineral Products and 2F Consumption of Halocarbons, Perfluorocarbons and SF₆. HFC emissions are estimated from refrigeration and air conditioning equipment as well as some SF₆ emissions from electrical equipment. The emissions have increased from 1990 to 2011, as shown in Table 4-1

Table 4-1 GHG emissions of source category 2 "Industrial Processes" 1990–2011 by gases. HFC, PFC and SF₆ in CO₂ equivalent (Gg).

Gas	Category	1990	1991	1992	1993	1994	1995	1996	1997	1998	1999
2A Mineral Products		Gg									
CO	2A5	0.020	0.020	0.020	0.020	0.020	0.020	0.019	0.019	0.019	0.020
NMVO	2A6	0.032	0.030	0.028	0.026	0.025	0.023	0.023	0.023	0.023	0.022
2F Consumption of Halocarbons and SF6		Gg CO₂ eq									
HFC	2F1, 2F4	0.00	0.00	0.01	0.05	0.14	0.38	0.66	1.04	1.38	1.81
PFC		NO	NO	NO	NO	NO	NO	NO	NO	0.00	0.00
SF6	2F8	NO	NO	NO	NO	NO	NO	2.4E-04	2.4E-04	2.4E-04	4.8E-03
Sum	2F	0.00	0.00	0.01	0.05	0.14	0.38	0.66	1.04	1.38	1.81

Gas	Category	2000	2001	2002	2003	2004	2005	2006	2007	2008	2009
2A Mineral Products		Gg									
CO	2A5	0.020	0.021	0.019	0.018	0.017	0.016	0.015	0.014	0.014	0.014
NMVO	2A6	0.021	0.019	0.018	0.017	0.017	0.016	0.020	0.022	0.022	0.022
2F Consumption of Halocarbons and SF6		Gg CO₂ eq									
HFC	2F1, 2F4	2.32	2.99	3.28	3.77	4.33	4.38	4.39	4.66	5.08	5.33
PFC		3.E-03	7.E-03	9.E-03	1.E-02	0.02	0.03	0.04	0.05	0.06	0.05
SF6	2F8	9.2E-02	1.7E-01	2.6E-01	2.6E-01	2.8E-01	2.7E-01	5.9E-02	1.2E-01	3.6E-01	1.4E-01
Sum	2F	2.41	3.17	3.54	4.04	4.63	4.68	4.49	4.83	5.50	5.53

Gas	Category	2010	2011
2A Mineral Products		Gg	
CO	2A5	0.013	0.014
NMVO	2A6	0.021	0.022
2F Halocarbons & SF6		Gg CO₂ eq	
HFC	2F1, 2F4	6.65	8.73
PFC		0.07	0.07
SF6	2F8	2.5E-02	1.4E-02
Sum	2F	6.75	8.81

The most obvious features of the emissions from industrial processes may be characterised as follows: The most relevant emissions are those of HFCs. The use of HFC started to be relevant as of 1992 when substances were introduced as substitutes for CFCs. Since then, HFC use experienced a steep growth from 0.009 Gg CO₂eq in 1992 up to 8.73 Gg CO₂eq in 2011.

4.2 Source Category 2A – Mineral Products

4.2.1 Source Category Description

Details on source category 2A "Mineral Products" are provided in the table below:

Table 4-2 Specification of source category 2A "Mineral Products"

2A	Source	Specification	Data Source
2A1	Cement Production	Not occurring in Liechtenstein.	-
2A2	Lime Production	Not occurring in Liechtenstein.	-
2A3	Limestone and Dolomite Use	Not occurring in Liechtenstein.	-
2A4	Soda Ash Production and Use	Not occurring in Liechtenstein.	-
2A5	Asphalt Roofing	Emissions of CO and NMVOC from asphalt roofing	AD: OS 2012c EF: FOEN 2012
2A6	Road Paving with Asphalt	Emissions of NMVOC from road paving	AD: OS 2012c EF: FOEN 2012
2A7	Other	Not occurring in Liechtenstein.	-

4.2.2 Methodological Issues

4.2.2.1 Asphalt Roofing (2A5) and Road Paving with Asphalt (2A6)

Methodology

For the determination of CO and NMVOC emissions from asphalt roofing and NMVOC emissions from road paving with asphalt, data availability in Liechtenstein is very limited. In order to establish rough estimates of emissions for Liechtenstein, the specific emissions per inhabitant in Switzerland (from FOEN 2012) are used as a proxy:

Emissions of CO and NMVOC from 2A5 and 2A6 in Liechtenstein are the product of the specific emissions per inhabitant in Switzerland times the number of inhabitants in Liechtenstein⁸.

This allows for a first preliminary estimate of emissions. The rationale behind this simple approach is that the general characteristics of Liechtenstein and Switzerland determining emissions are roughly similar.

Emission Factors

Emission factors for CO and NMVOC, the specific emissions per inhabitant, are calculated by dividing the emissions from Asphalt Roofing (2A5) and Road Paving with Asphalt (2A6) from the Swiss national inventory (FOEN 2012) by the number of inhabitants in Switzerland (see Table 4-3).

Activity Data

The activity data is the number of inhabitants in Liechtenstein as provided in the Table below (OS 2012c). For the year 2011 preliminary data for the number of inhabitants is taken from OS 2012d.

⁸ This approach is used for all years but the latest (2011). Here, for Liechtenstein the specific emission factor of Switzerland of the previous year (2010) are used, because the Swiss National Inventory (NIR) is published only after the drafting of Liechtenstein's NIR. For the next submission, the emission factors used for Liechtenstein will be updated according to the latest Swiss NIR.

Table 4-3 Inhabitants in Liechtenstein 1990 - 2011 (OS 2012c and OS 2012d) and inhabitants in Switzerland (SFOE 2012).

Inhabitants	1990	1991	1992	1993	1994	1995	1996	1997	1998	1999
Liechtenstein	29'032	29'386	29'868	30'310	30'629	30'923	31'143	31'320	32'015	32'426
Switzerland	6'796'000	6'880'000	6'943'000	6'989'000	7'037'000	7'081'000	7'105'000	7'113'000	7'132'000	7'167'000
Liechtenstein/Switzerland	0.43%	0.43%	0.43%	0.43%	0.44%	0.44%	0.44%	0.44%	0.45%	0.45%
Inhabitants	2000	2001	2002	2003	2004	2005	2006	2007	2008	2009
Liechtenstein	32'863	33'525	33'863	34'294	34'600	34'905	35'168	35'356	35'589	35'894
Switzerland	7'209'000	7'285'000	7'343'000	7'405'000	7'454'000	7'501'000	7'558'000	7'619'000	7'711'000	7'801'000
Liechtenstein/Switzerland	0.46%	0.46%	0.46%	0.46%	0.46%	0.47%	0.47%	0.46%	0.46%	0.46%
Inhabitants	2010	2011								
Liechtenstein	36'149	36'475								
Switzerland	7'878'000	7'954'700								
Liechtenstein/Switzerland	0.46%	0.46%								

The number of inhabitants in Liechtenstein has been adjusted for the year 2010 due to adjusted data in (OS 2012c). Preliminary data on the Swiss inhabitants for the year 2010 has been adjusted according to the definite data published in SFOE 2012.

4.2.3 Uncertainties and Time-Series Consistency

No uncertainty assessment has been executed for CO and NMVOC emissions according to the IPCC guidelines.

The time series is consistent.

4.2.4 Source-Specific QA/QC and Verification

The source-specific QA/QC activities have been carried out as mentioned in sections 1.6.1.4 and 1.6.1.5 including also the triple check of the CRF tables (detailed comparison of latest with previous data for the base year, for 2010 and for the changing rates 2010/2011).

4.2.5 Source-Specific Recalculations

Preliminary data on the Swiss inhabitants for the year 2010 has been adjusted according to the definite data published in SFOE 2012.

4.2.6 Source-Specific Planned Improvements

No source-specific improvements are planned.

4.3 Source Category 2B – Chemical Industry

GHG emissions from source category 2B are not occurring in Liechtenstein.

4.4 Source Category 2C – Metal Production

GHG emissions from source category 2C are not occurring in Liechtenstein.

4.5 Source Category 2D – Other Production

GHG emissions from source category 2D are not occurring in Liechtenstein.

4.6 Source Category 2E – Production of Halocarbons and SF₆

GHG emissions from source category 2E are not occurring in Liechtenstein.

4.7 Source Category 2F – Consumption of Halocarbons and SF₆

4.7.1 Source Category Description

Key category 2F

HFC from source category 2F “Consumption of halocarbons and SF₆” is a key category regarding level and trend.

Source category 2F comprises HFC, PFC and SF₆ emissions from consumption of the applications listed below. Other applications are not occurring in Liechtenstein.

Table 4-4 Specification of source category 2F “Consumption of Halocarbons and SF₆” (AD: activity data; EF: emission factors).

2F	Source	Specification	Data Source
2F1	Refrigeration and Air Conditioning Equipment	Emissions from Refrigeration and Air Conditioning Equipment	AD: Number of households, employees, passenger cars EF: Industry data for Switzerland (FOEN 2012, Carbotech 2012)
2F2	Foam Blowing	Emissions from Refrigeration and Air Conditioning Equipment	AD: Number of households, employees, passenger cars EF: Industry data for Switzerland (FOEN 2012, Carbotech 2012)
2F8	Electrical Equipment	Emissions from use in electrical equipment	AD: Industry data EF: Industry data

4.7.2 Methodological Issues

2F1 Refrigeration and Air Conditioning Equipment

Methodology

Liechtenstein does not have the relevant import statistics or industry data which would allow developing specific data models to estimate the emissions under source category 2F1. Therefore the emissions for Liechtenstein are estimated using a country specific methodology by applying the rule of proportion on basis of the emissions reported by Switzerland and specific indicators. The method is therefore based on a Tier 2 method as suggested by the IPCC guidelines. However this approach is used in a first step to determine the Swiss emissions, since therefore import statistics are available. In a second step for determination of Liechtensteins emissions from 2F1 the emission from Switzerland are used and are adapted to Liechtensteins's structural setting with a transformation of data based on relevant indicators such as population, number of households, number of employees, number of cars. As it can be assumed that the consumption patterns for industry, service sector and household sector of Liechtenstein are very similar to Switzerland, this approach will result in reliable figures for Liechtenstein. While the emission factors are assumed to be identical for both countries, the specific indicators for the rule of proportion calculation are chosen under the criteria that they shall be suitable to derive the activity data for Liechtenstein on basis of data for Switzerland. Since the National Inventory report 2010 for Liechtenstein (OEP 2010b), all gases including the PFCs as reported by Switzerland are included and emission data for 1990 is also estimated by applying the rule of proportion. In earlier inventories the emissions reported for 1990 were based on a country specific estimate, while emissions for later years were estimated by applying the rule of proportion.

In the Swiss Inventory PFC emissions under 2F1 result from Commercial Refrigeration and Transport Refrigeration. For each of these types of equipment individual Tier 2 emission models are used for calculating emissions. In order to obtain the most reliable data for the calculations, two different approaches are applied to get the stock data needed for the model calculations: 'top down' using available statistics or estimations on the Swiss market from experts and associations and 'bottom up' through questionnaires sent to companies active in importation, production and service of appliances.

More details of the underlying data models can be seen from the National Inventory Report for Switzerland (FOEN 2012) and Carbotech 2012.

In the present submission of the National Inventory Report by Liechtenstein, EFs used to estimate emissions from the consumption of halocarbons and SF₆ are still based on the GHG inventory submitted by Switzerland for 2010 (FOEN 2012), as the 2013 submission by Switzerland was not available at that time. Revised estimates are submitted once the Swiss activity data for the same year of Liechtenstein submission become available.

Manufacturing of refrigeration and air conditioning equipment is not occurring in Liechtenstein. Disposal of retired equipment falling under the categories of Domestic Refrigeration, Mobile Air Conditioning and Transport Refrigeration is by large through a single recycling company in Liechtenstein (Elkuch Recycling AG). The recycling company collects and exports the equipment to Switzerland or Austria without recovery of the synthetic gases in the refrigeration or Air Conditioning units. Nevertheless, Liechtenstein's emissions are estimated on basis of the rule of proportion applied onto the sum of emissions for Switzerland including manufacturing, product life emissions and disposal losses. For more precision, the rule of proportion should be restricted to product life emissions and the Swiss manufacturing emissions should be excluded from the calculation. Since the manufacturing emissions in Switzerland are of low relative importance, this bias is neglected. The inclusion of emissions from disposal are a conservative estimate for Liechtenstein. As the statistical basis for a more detailed analysis is not available, the effect is also neglected and the conservative estimation is accepted. For Switzerland, the emissions from manufacturing and

disposal account for 13.1% of the total emissions under source category 2F1 (emission data of the inventory year 2010).

For the period from 2004 to 2006 a stagnating trend can be noted for HFCs emissions with only a marginal interannual increase in an otherwise strongly increasing long term trend between 1990 and 2009. Analysis has been carried out on the reasons for the observed trend change. The HFC emissions for Switzerland, which are the basis for Liechtenstein's emission data, do not show a similar trend in the grand total of HFC emissions and also not in the emission totals from the different types of equipment. Therefore the development is determined by the interaction of the indicators used for the rule of proportion calculations and therefore is only a methodological trend. For 2006 onwards, Liechtenstein's trend for HFC emissions is again in line with the trend for Switzerland. However, for the next inventory submission a new model will be introduced in order to properly separate the emissions of Switzerland and Liechtenstein with the aim to avoid double counting and which will also help to avoid artefacts such as the one discussed above.

The inventory under this source category includes the following types of equipment: domestic refrigeration, commercial and industrial refrigeration, transport refrigeration, stationary air conditioning and mobile air conditioning. The indicators used for the rule of proportion calculations are summarised in the following table.

Table 4-5 Indicators used in calculating Liechtenstein's emissions for source category 2F1 on basis of Switzerland's emissions by applying rule of proportion.

Application	Refrigerant	Base value	Indicator for calculation by rule of proportion
Domestic Refrigeration	HFC-134a	Total emissions reported for Switzerland	Number of households
Commercial Refrigeration	HFC-125 HFC-134a HFC-143a C3F8	Total emissions reported for Switzerland	Number of persons employed in industrial and service sector
Transport Refrigeration	HFC-125 HFC-134a HFC-143a	Total emissions reported for Switzerland	Number of inhabitants
Industrial Refrigeration	Included in commercial refrigeration		
Stationary Air Conditioning	HFC-32 HFC-125 HFC-134a HFC-143a	Total emissions reported for Switzerland	Number of persons employed in industrial and service sector
Mobile Air Conditioning	HFC-134a	Total emissions reported for Switzerland (cars, trucks, railway)	Number of registered cars

Emission Factors

Due to the approach chosen, the emission factors as reported in the Swiss National Inventory Report (FOEN 2012) are applicable.

The data reported in Table 4-8 is taken from FOEN 2012 and shows details to the emission factors. No manufacturing of refrigeration and air conditioning equipment is occurring in Liechtenstein.

Table 4-6 Typical values on life time, charge and emission factors used in model calculations for Refrigeration and Air Conditioning Equipment. Where values in brackets are provided, the first value shows the assumption for 1995 while the second value (in brackets) shows the assumption for 2010 respectively 2020. Data between 1995 and 2010 respectively 2020 is linearly interpolated. Source: FOEN 2012, Carbotech 2012.

Equipment type	Product life time [a]	Initial charge of new product [kg]	Manufacturing emission factor [% of initial charge]	Product life emission factor [% per annum]	Charge at end of life [% of initial charge of new product] *)	Disposal loss emission factor [% of remaining charge]
Domestic Refrigeration	16	0.1	NO	0.5	92	19 **)
Commercial and Industrial Refrigeration	10	NR	0.5	12 (2020: 5)	100	10
Transport Refrigeration / Trucks	10	1.8 ... 7.8	NO	10	100	10
Transport Refrigeration / Railway	12	NR	NO	10	100	10
Stationary Air Conditioning (direct / indirect cooling system)	15	NR	direct: 3 indirect: 1	direct: 10 (2010: 3) indirect: 6 (2010: 4)	100	direct: 28 indirect: 19
Heat Pumps	15	4.7 ... 7.5 till 1999 Going down to 2.8 ... 4.5 in 2010	3	2	100	10
Mobile Air Conditioning / Cars	12	0.7 (0.84) ***)	NO	8.5	58	100 until year 2000 50 since 2005****)
Mobile Air Conditioning / Trucks	12	1.1	NO	10 until year 2000 Going down to 8.5 in 2010	35	100 until year 2000 50 since 2001****)
Mobile Air Conditioning / Buses	12	7.5	NO	10 until year 2000 Going down to 8.5 in 2010	35	100 until year 2000 50 since 2001****)
Mobile Air Conditioning / Railway	13	20	NO	4	100	10

*) takes into account refill of losses during product life where applicable.

**) takes into account R134a content in foams, based on information from the national recycling organisation SENS.

***) Assumed constant since 2002. 0.84 kg in 1990. Linear interpolation between 1990 and 2002.

****) the value of 100% is based on expert assumptions. It however is not relevant for HFC emissions due to introduction of HFCs in MAC from 1991 only and 12 resp. 15 years lifetime (HFC disposal losses occur from 2003 onwards for Trucks/Buses resp. from 2006 for Cars). Value of 50% is based on UBA 2005 and expert assumptions on share of total refrigerant loss, e.g. due to road accident.

NA = not available

NR = not relevant as only aggregate data is used

NO = Not occurring (only import of charged units)

Activity Data

Activity data for Liechtenstein is calculated based on activity data for Switzerland with the methodology as described above. The following figures have been used for the indicators:

Table 4-7 Figures used as indicators for calculation of activity data by applying rule of proportion.

	1990		2011	
Number of households				
Liechtenstein	10'556	Source: National census 1990 (OEA 2000)	16'643	Source: National census 2000 with trend extrapolation (OEA 2000)
Switzerland	2'859'766	Source: National census 1990 (SFSO 2012a)	3'558'039	Source: National census 2000 with trend extrapolation (SFSO 2012a)
Conversion Factor CH→LIE	0.0036912		0.0046776	
Number of employees in industrial and service sector				
Liechtenstein	19'554	Source: Statistical Yearbook Liechtenstein (OS 2012b)	36'037	Source: Statistical Yearbook Liechtenstein (OS 2012b)
Switzerland	3'664'214	Source: National census of enterprises 1985 and 1991, interpolated (SFSO 2012b)	3'739'728	Source: National census of enterprises 2001 and 2005, extrapolated (SFSO 2012b)
Conversion Factor CH→LIE	0.0053365		0.00096363	
Number of registered passenger cars				
Liechtenstein	16'891	Source: Statistical Yearbook Liechtenstein (OS 2012c)	27'327	Source: Statistical Yearbook Liechtenstein (OS 2012c)
Switzerland	2'985'399	Source: National motorcar statistics for Switzerland (SFSO 2012c)	4'163'003	Source: National motorcar statistics for Switzerland (SFSO 2012c)
Conversion Factor CH→LIE	0.0056579		0.0065643	

2F2 Foam Blowing

Methodology

Liechtenstein does not have the relevant import statistics or industry data which would allow developing specific data models to estimate the emissions under source category 2F2. Therefore the emissions for Liechtenstein are estimated using a country specific methodology by applying the rule of proportion on basis of the emissions reported by Switzerland based on number of inhabitants. As it can be assumed that the consumption patterns of Liechtenstein are very similar to Switzerland, this approach will result in reliable figures for Liechtenstein. While the emission factors are assumed to be identical for both countries, the specific indicator for the rule of proportion calculation is chosen under the criteria that it shall be suitable to derive the activity data for Liechtenstein on basis of data for Switzerland. As manufacturing of foams is not occurring in Liechtenstein, only emissions during life of product and disposal are considered. Emissions under source category 2F2 are

related to hard foams only. For soft foams, manufacturing using HFC is not occurring in Switzerland or Liechtenstein. As for soft foams emissions are occurring only during production emissions from soft foams are NO.

More details of the underlying data models can be seen from the National Inventory Report for Switzerland (FOEN 2012) and Carbotech 2012.

Emission Factors

Due to the approach chosen, the emission factors as reported in the Swiss National Inventory Report (FOEN 2012) are applicable.

The data reported in Table 4-8 is taken from FOEN 2012 and shows details to the emission factors. No manufacturing of foams is occurring in Liechtenstein.

Table 4-8 Typical values on life time, charge and emission factors used in model calculations for foam blowing. Source: FOEN 2012, Carbotech 2012.

Application	Product life time years	Charge of new product % of product weight	Manufacturing emission factor % of initial charge	Product life emission factor % per annum	Charge at end of life % charge of new product
PU foam	50	4.5	NR	NR	NR
XPS foam HFC 134a HFC 152a	50	6.5	NO	10 / 0.7** 100 / 0**	64% 0%
PU spray	50	13.6 / 0 *	0.8	95 / 2.5 **	0
Sandwich Elements HFC 134a, HFC 227ea, HFC 365 mfc HFC 152a	50	3	10 100	0.7 0	64 0

* Data for 1990 / 2009

** Data for 1st year / following years

NR Not relevant, because no substances according to this protocol has been used, all emissions occur outside Switzerland during production

NO Not occurring, because XPS not produced in Switzerland

Activity Data

Activity data for Liechtenstein is calculated based on activity data for Switzerland with the methodology as described above. The following figures have been used for the indicators:

Table 4-9 Figures used as indicator for calculation of activity data by applying rule of proportion.

2011		
Number of Inhabitants		
Liechtenstein	36'475	Source: (OS 2012d)
Switzerland	7'954'700	Source: (SFSO 2012d)
Conversion Factor CH→LIE	0.0045855	

2F4 Aerosols / Metered Dose Inhalers

Methodology

Liechtenstein does not have the relevant import statistics or industry data which would allow developing specific data models to estimate the emissions under source category 2F4 Aerosols / Metered Dose Inhalers. Therefore the emissions for Liechtenstein are estimated using a country specific methodology by applying the rule of proportion on basis of the emissions reported by Switzerland and using the number of inhabitants as indicator. As it can be assumed that the consumption patterns of Liechtenstein are very similar to Switzerland, this approach will result in reliable figures for Liechtenstein. While the emission factors are assumed to be identical for both countries, the specific indicator for the rule of proportion calculation is chosen under the criteria that it shall be suitable to derive the activity data for Liechtenstein on basis of data for Switzerland. To restrict the complexity of the estimation model for Liechtenstein, gases with very low emissions in Switzerland are neglected. The absolute relevance of the emissions reported under 2F4 is very low (less than 0.1 Gg CO₂eq) and therefore inaccuracies in the estimation model are considered negligible.

More details of the underlying data models can be seen from the National Inventory Report for Switzerland (FOEN 2012) and Carbotech 2012.

Emission Factors

Due to the approach chosen, the emission factors as reported in the Swiss National Inventory Report (FOEN 2012) are applicable.

Activity Data

Activity data for Liechtenstein is calculated based on activity data for Switzerland with the methodology as described above. The figures as seen in Table 4-9 have been used as indicator.

2F8 Electrical Equipment

Methodology

The only SF₆ emissions in Liechtenstein stem from the transformers operated by the utility Liechtensteinische Kraftwerke (LKW). The LKW reports on activity data and emissions with a T3 method. A complete mass balance analysis is conducted by LKW on installation level, which was reconfirmed by LKW in 2011. No production of equipment with SF₆ is occurring.

Emission Factors

Emission factors for this source category are based on industry information.

Activity Data

Activity data is based on industry information. Before 1995/1996 a different technology was applied which did not use SF₆. A declining trend of SF₆ emissions can be observed from 2008 to 2011. This decline is within the range of variability since only one company is involved (LKW) and individual changes in emissions become evident accordingly in total emissions from source category 2F8. In preceeding years a similar variability in emissions can be observed (decrease from 2005 to 2006, increase 2006-2008). Variability can be a result of changing reporting periods and/or changes (reductions) in actual maintenance and repair interventions.

4.7.3 Uncertainties and Time-Series Consistency

For source category 2F Consumption of halocarbons and SF₆ no specific uncertainties have been determined. For the Swiss GHG inventory (FOEN 2012), the uncertainties of the emissions of HFC without 2F1 under source category 2F were at 18.8% (Monte Carlo simulation based on 2010 data).

For Liechtenstein's uncertainty analysis, a value of 20% was adopted for HFC, PFC and SF₆ in 2F (non-key category), according to Table 1-5 is assumed.

The methods for calculating the emissions of the full time series 1990–2011 are consistent.

4.7.4 Source-Specific QA/QC and Verification

In order to confirm the plausibility of the emission data for Liechtenstein the NIR authors have performed various cross-checks between the CRF data for source category 2F Consumption of halocarbons and SF₆ as reported for Switzerland and Liechtenstein. The emissions for Liechtenstein under this source category are estimated to a large extent by applying the rule of proportion as used for respective data in Switzerland. Consistency of the data was confirmed by these checks.

Under 2F3, emissions from Fire Extinguishers are reported as not occurring since no emissions are occurring in this sector within Switzerland. The application of HFC, PFC and SF₆ in fire extinguishers is prohibited by law in Switzerland. For the 2010 GHG inventory of Liechtenstein (OEP 2012a) it has been checked with industry representatives if this assumption is correct also for Liechtenstein. They confirmed that there is neither production nor disposal or known stocking of fire extinguishers using HFC, PFC or SF₆. Therefore it can be assumed that the notation key NO is correct for Liechtenstein.

For the inventory 2010 (OEP 2012a) the sum of SF₆ emissions reported by Liechtenstein for 1996-2010 for source category 2F8 Electrical Equipment as potential and actual emissions have been checked with the Liechtensteinische Kraftwerke (LKW 2010) and were confirmed to be reasonable in view of the installation based data from the electrical equipment operated by the Liechtensteinische Kraftwerke.

Referring to the last submission, in CRF Table2(II)s2 for HFC and PFC actual emissions and potential/actual emission ratio are shown while the potential emissions are indicated as not occurring (NO) which is not correct. Checks have been performed to identify the problem with the result that this seems to be a problem of the CRF reporter which can not be solved by Liechtenstein. The potential emission data is available in the table CRF Table 2(I)s2.

In addition to these source-specific activities, the source-specific QA/QC activities have been carried out as mentioned in sections 1.6.1.4 and 1.6.1.5 including also the triple check of the CRF tables (detailed comparison of latest with previous data for the base year, for 2010 and for the changing rates 2010/2011).

4.7.5 Source-Specific Recalculations

Preliminary data on the Swiss inhabitants for the year 2010 has been adjusted according to the definite data published in SFOE 2012.

4.7.6 Source-Specific Planned Improvements

Gradual improvement of the data quality in co-operation with industry is ongoing for the Swiss GHG inventory. Methodologies and emission models will be updated during the yearly process of F-gas inquiry. The focus will be on improvements of HFC-emission calculations from refrigeration and air-conditioning equipment. As the GHG emissions for Liechtenstein under source category 2F are methodologically based on the Swiss GHG inventory data this will also benefit the GHG inventory for Liechtenstein.

At the time of preparing the CRF tables for the present submission a major revision was planned for the GHG inventory of Switzerland in order to properly separate the emissions of Switzerland and Liechtenstein with the aim to avoid double counting (note: Switzerland and Liechtenstein have a common import statistic. So far the GHG inventory of Switzerland reports under the source category 2F the sum of emissions occurring in Switzerland and Liechtenstein wherever emission models are based on data taken from import statistics). Therefore it was decided that no recalculation for the period 1990-2010 is made.

In the meantime the planned major revision had to be delayed and only will be effective for the submission of the GHG inventory of Switzerland in April 2013. Once this is implemented, OEP will analyse the situation and will then decide if the methodology for the inventory of Liechtenstein for source category 2F will be revised for Submission 2014. If a revision is conducted, this will also lead to recalculation of the data for the entire time period starting from 1990.

4.8 Source Category 2G – Other

GHG emissions from source category 2G are not occurring in Liechtenstein.

5 Solvent and Other Product Use

5.1 Overview

This chapter provides information on the estimation of greenhouse gas emissions from solvent and other product use (see Figure 5-1 and Table 5-1). Reported emissions comprise NMVOC emissions from the use of solvents. Also reported are CO₂ emissions resulting from post-combustion of NMVOCs and indirect CO₂ emission due to atmospheric decomposition of NMVOC. Furthermore, evaporative emissions of N₂O arising from other types of product use and from medical use are included.

Source category 3 "Solvent and Other Product Use" is **not a key category**.

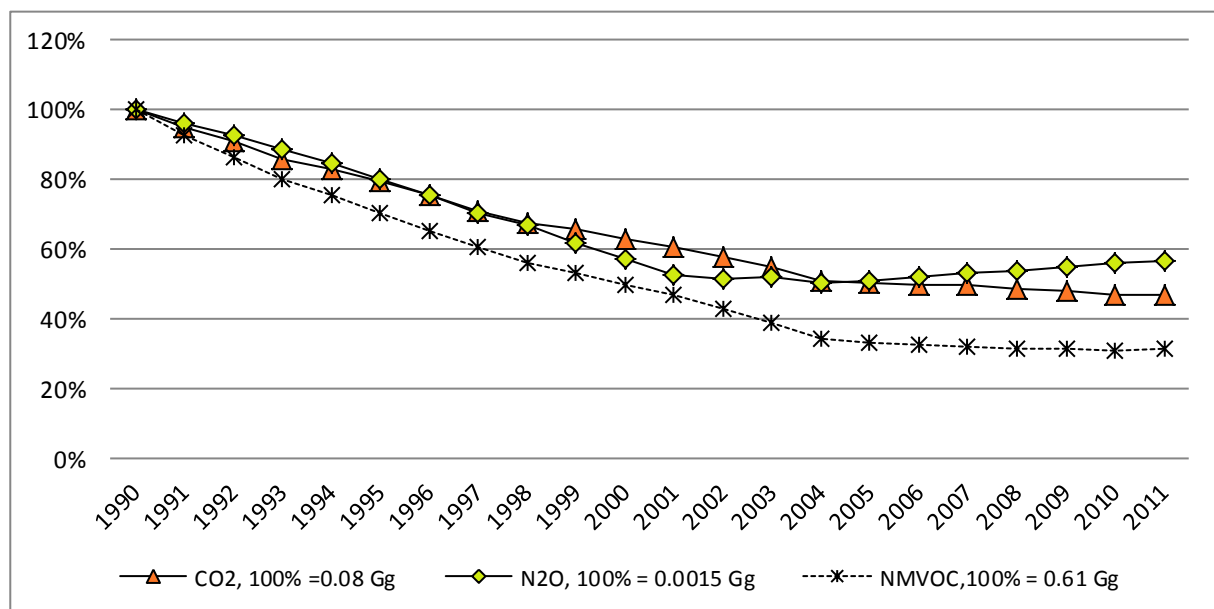

Figure 5-1 Overview of emissions in category 3 Solvent and Other Product Use in Liechtenstein 1990–2011.

Table 5-1 Emissions of source category 3 Solvent and Other Product Use in Liechtenstein 1990-2011.

Gas	1990	1991	1992	1993	1994	1995	1996	1997	1998	1999
	Gg									
CO ₂	1.55	1.46	1.40	1.33	1.29	1.23	1.17	1.10	1.05	1.01
N ₂ O	0.0015	0.0015	0.0014	0.0013	0.0013	0.0012	0.0011	0.0011	0.0010	0.0009
NMVOG	0.61	0.56	0.53	0.49	0.46	0.43	0.40	0.37	0.34	0.32

Gas	2000	2001	2002	2003	2004	2005	2006	2007	2008	2009
	Gg									
CO ₂	0.97	0.94	0.89	0.84	0.79	0.78	0.77	0.77	0.75	0.75
N ₂ O	0.0009	0.0008	0.0008	0.0008	0.0008	0.0008	0.0008	0.0008	0.0008	0.0008
NMVOG	0.30	0.28	0.26	0.24	0.21	0.20	0.20	0.19	0.19	0.19

Gas	2010	2011
	Gg	
CO ₂	0.72	0.73
N ₂ O	0.0008	0.0009
NMVOG	0.19	0.19

The emissions of NMVOG, CO₂ and N₂O are all calculated by a country specific method from the corresponding Swiss emissions by using the specific emission per inhabitant as conversion factors. Two reduction efforts are responsible for the decrease of the emissions: The limitation of the application of NMVOG brought by the legal restrictions (Government 1986 and 2003) and the introduction of the VOC-levy in 2000 in Liechtenstein and Switzerland (based on the Customs Union Treaty the Swiss VOC-levy is also applicable in Liechtenstein).

5.2 Source Category 3A – Paint Application

5.2.1 Source Category Description

Source category 3A Paint Application comprises NMVOG emissions from paints, lacquers, thinners and related materials used in coatings in industrial, commercial and household applications. Also, it includes direct CO₂ emissions resulting from post-combustion of NMVOG to reduce NMVOG in exhaust gases as well as indirect CO₂ emission due to atmospheric decomposition of NMVOG.

Table 5-2 Specification of source category 3A "Paint Application".

	Source	Specification	Data Source
3A	Paint Application	Paint application in households, industry and construction	AD: OS 2012c EF: FOEN 2012

5.2.2 Methodological Issues

5.2.2.1 Methodology

Data availability in Liechtenstein is very limited. In order to establish rough estimates of emissions for Liechtenstein, the specific emissions per inhabitant in Switzerland are used as a proxy:

Emissions of NMVOC and CO₂ from the source category 3A in Liechtenstein are the product of the specific emissions per inhabitant in Switzerland times the number of inhabitants in Liechtenstein.⁹

This allows for a first preliminary estimate of emissions. The rationale behind this simple approach is that the general characteristics of Liechtenstein and Switzerland determining emissions are roughly similar.

5.2.2.2 Emission Factors

Emission factors for NMVOC and CO₂, which is the specific emissions per inhabitant, are calculated by dividing the emissions from source category 3A from the Swiss national inventory (FOEN 2012) by the number of inhabitants in Switzerland (see Table 4-3 in section 4.2.2).

Table 5-3 Emission factors - specific emissions per inhabitant 1990 to 2011 (Source: Swiss emissions from FOEN 2012; inhabitants see Section 4.2.2).

Source	Unit	1990	1991	1992	1993	1994	1995	1996	1997	1998	1999
3A. Paint Application											
CO ₂	g/inhabitant	14'612	14'223	13'804	13'227	12'604	11'874	11'067	10'219	9'290	8'875
NMVOC	g/inhabitant	6'175	5'953	5'719	5'468	5'185	4'874	4'531	4'167	3'766	3'584

Source	Unit	2000	2001	2002	2003	2004	2005	2006	2007	2008	2009
3A. Paint Application											
CO ₂	g/inhabitant	8'461	8'027	6'872	5'610	4'218	4'148	4'232	4'182	4'075	3'934
NMVOC	g/inhabitant	3'404	3'213	2'726	2'189	1'607	1'578	1'546	1'512	1'453	1'396

Source	Unit	2010	2011
3A. Paint Application			
CO ₂	g/inhabitant	3'760	3'760
NMVOC	g/inhabitant	1'344	1'344

5.2.2.3 Activity Data

The development of the number of inhabitants in Liechtenstein is provided in Section 4.2.2.

5.2.3 Uncertainties and Time-Series Consistency

The uncertainty of CO₂ emissions from the entire source category 3 Solvent and Other Product Use is estimated to be 80% (expert estimate based on uncertainty of Swiss data and uncertainty of simple approach).

For NMVOC emissions no uncertainty assessment is done according to the IPCC guideline.

The time series is consistent.

5.2.4 Source-Specific QA/QC and Verification

The source-specific QA/QC activities have been carried out as mentioned in sections 1.6.1.4 and 1.6.1.5 including also the triple check of the CRF tables (detailed comparison of latest with previous data for the base year, for 2010 and for the changing rates 2010/2011).

⁹ This approach is used for all years but the latest (2011). Here, for Liechtenstein the specific emission factor of Switzerland of the previous year (2010) are used, because the Swiss National Inventory is published only after the drafting of Liechtenstein's NIR. For the next submission, the emission factors used for Liechtenstein will be updated according to the latest Swiss NIR.

5.2.5 Source-Specific Recalculations

The indirect CO₂ emissions due to atmospheric decomposition of NMVOC from source category 3 Solvent and Other Product Use was moved back from chapter 9 into chapter 5. For the rationale behind this reallocation see last year's submission (OEP 2012b).

Due to the re-allocation, recalculations have been done on the whole time series.

5.2.6 Source-Specific Planned Improvements

No source-specific improvements are planned.

5.3 Source Category 3B – Degreasing and Dry Cleaning

5.3.1 Source Category Description

Source category 3B comprises NMVOC emissions from degreasing, dry cleaning and cleaning in electronic industry. Also, it includes direct CO₂ emissions resulting from post-combustion of NMVOC to reduce NMVOC in exhaust gases as well as indirect CO₂ emission due to atmospheric decomposition of NMVOC.

Table 5-4 Specification of source category 3B "Degreasing and Dry Cleaning".

	Source	Specification	Data Source
3B	Degreasing and Dry Cleaning	Degreasing; dry cleaning; cleaning of electronic components; cleaning of parts in metal processing; other industrial cleaning	AD: OS 2012c EF: FOEN 2012

5.3.2 Methodological Issues

5.3.2.1 Methodology

Data availability in Liechtenstein is very limited. In order to establish rough estimates of emissions for Liechtenstein, the specific emissions per inhabitant in Switzerland are used as a proxy:

Emissions of NMVOC and CO₂ from the source category 3B in Liechtenstein are the product of the specific emissions per inhabitant in Switzerland and the number of inhabitants in Liechtenstein.¹⁰

This basis allows a first preliminary estimate of emissions. The rationale behind this simple approach is that the general characteristics of Liechtenstein and Switzerland determining emissions are mainly similar.

5.3.2.2 Emission Factors

Emission factors for NMVOC and CO₂, which are the specific emissions per inhabitant, are calculated by dividing the emissions from source category 3B from the Swiss national

¹⁰ This approach is used for all years but the latest (2011). Here, for Liechtenstein the specific emission factor of Switzerland of the previous year (2010) are used, because the Swiss National Inventory is published only after the drafting of Liechtenstein's NIR. For the next submission, the emission factors used for Liechtenstein will be updated according to the latest Swiss NIR.

inventory (FOEN 2012) by the number of inhabitants in Switzerland (see Table 4-3 in section 4.2.2).

Table 5-5 Emission factors - specific emissions per inhabitant 1990 to 2011 (Source: Swiss emissions from FOEN 2012; inhabitants see Section 4.2.2).

Source	Unit	1990	1991	1992	1993	1994	1995	1996	1997	1998	1999
3B. Degreasing and Dry Cleaning											
CO ₂	g/inhabitant	3'992	3'621	3'285	2'970	2'660	2'365	2'087	1'824	1'567	1'472
NMVOOC	g/inhabitant	1'785	1'619	1'466	1'322	1'184	1'052	928	810	695	653

Source	Unit	2000	2001	2002	2003	2004	2005	2006	2007	2008	2009
3B. Degreasing and Dry Cleaning											
CO ₂	g/inhabitant	1'375	1'273	1'176	1'079	983	907	831	755	737	719
NMVOOC	g/inhabitant	610	564	521	477	434	400	366	333	325	317

Source	Unit	2010	2011
3B. Degreasing and Dry Cleaning			
CO ₂	g/inhabitant	712	712
NMVOOC	g/inhabitant	310	310

5.3.2.3 Activity Data

The development of the number of inhabitants in Liechtenstein is provided in Section 4.2.2.

5.3.3 Uncertainties and Time-Series Consistency

The uncertainty of CO₂ emissions from the entire source category 3 Solvent and Other Product Use is estimated to be 80% (expert estimate based on uncertainty of Swiss data and uncertainty of simple approach).

For NMVOOC emissions no uncertainty assessment is done according to the IPCC guideline.

The time series is consistent.

5.3.4 Source-Specific QA/QC and Verification

The source-specific QA/QC activities have been carried out as mentioned in sections 1.6.1.4 and 1.6.1.5 including also the triple check of the CRF tables (detailed comparison of latest with previous data for the base year, for 2010 and for the changing rates 2010/2011).

5.3.5 Source-Specific Recalculations

The indirect CO₂ emissions due to atmospheric decomposition of NMVOOC from source category 3 Solvent and Other Product Use was moved from chapter 9 back into chapter 5. For the rationale behind this reallocation see last year's submission (OEP 2012b).

Due to the re-allocation, recalculations have been done on the whole time series.

5.3.6 Source-Specific Planned Improvements

No source-specific improvements are planned.

5.4 Source Category 3C – Chemical Products, Manufacture and Processing

5.4.1 Source Category Description

Source category 3C Chemical Products, Manufacture and Processing comprises NMVOOC emissions from manufacturing and processing of chemical products. Also, it includes direct

CO₂ emissions resulting from post-combustion of NMVOC to reduce NMVOC in exhaust gases as well as indirect CO₂ emission due to atmospheric decomposition of NMVOC.

Table 5-6 Specification of source category 3C "Chemical Products, Manufacture and Processing".

	Source	Specification	Data Source
3C	Chemical Products, Manufacture and Processing	Handling and storage of solvents; fine chemical production; production of pharmaceuticals; manufacturing of paint, inks, glues, adhesive tape, rubber; processing of PVC, polystyrene foam, polyurethane and polyester	AD: OS 2012c EF: FOEN 2012

5.4.2 Methodological Issues

5.4.2.1 Methodology

Data availability in Liechtenstein is very limited. In order to establish rough estimates of emissions for Liechtenstein, the specific emissions per inhabitant in Switzerland are used as a proxy:

Emissions of NMVOC and CO₂ from the source category 3C in Liechtenstein are the product of the specific emissions per inhabitant in Switzerland and the number of inhabitants in Liechtenstein.¹¹

This basis allows a first preliminary estimate of emissions. The rationale behind this simple approach is that the general characteristics of Liechtenstein and Switzerland determining emissions are mainly similar.

5.4.2.2 Emission Factors

Emission factors for NMVOC and CO₂, which represent the specific emissions per inhabitant, are calculated by dividing the emissions from source category 3C from the Swiss national inventory (FOEN 2012) by the number of inhabitants in Switzerland (see Table 4-3 in section 4.2.2).

Table 5-7 Emission factors - specific emissions per inhabitant 1990 to 2011 (Source: Swiss emissions from FOEN 2012; inhabitants see Section 4.2.2).

Source	Unit	1990	1991	1992	1993	1994	1995	1996	1997	1998	1999
3C. Chemical Products, Manufacture and Processing											
CO ₂	g/inhabitant	11'395	9'748	8'354	6'901	6'455	5'898	5'414	5'076	4'827	4'842
NMVOC	g/inhabitant	4'162	3'362	2'633	1'934	1'715	1'474	1'261	1'115	948	885

Source	Unit	2000	2001	2002	2003	2004	2005	2006	2007	2008	2009
3C. Chemical Products, Manufacture and Processing											
CO ₂	g/inhabitant	4'635	4'475	4'561	4'587	4'684	4'756	4'660	4'491	4'333	4'254
NMVOC	g/inhabitant	782	708	661	624	579	563	553	549	537	527

Source	Unit	2010	2011
3C. Chemical Products, Manufacture and Processing			
CO ₂	g/inhabitant	3'507	3'507
NMVOC	g/inhabitant	518	518

¹¹ This approach is used for all years except the latest (2011). Here, for Liechtenstein the specific emission factor of Switzerland of the previous year (2010) is used, as the publication of the Swiss National Inventory is only after the drafting of Liechtenstein's NIR. For the next submission, the emission factors used for Liechtenstein will be updated according to the latest Swiss NIR.

5.4.2.3 Activity Data

The development of the number of inhabitants in Liechtenstein is provided in Section 4.2.2.

5.4.3 Uncertainties and Time-Series Consistency

The uncertainty of CO₂ emissions from the entire source category 3 Solvent and Other Product Use is estimated to be 80% (expert estimate based on uncertainty of Swiss data and uncertainty of simple approach).

For NMVOC emissions no uncertainty assessment has been executed according to the IPCC guideline.

The time series is consistent.

5.4.4 Source-Specific QA/QC and Verification

The source-specific QA/QC activities have been carried out as mentioned in sections 1.6.1.4 and 1.6.1.5 including also the triple check of the CRF tables (detailed comparison of latest with previous data for the base year, for 2010 and for the changing rates 2010/2011).

5.4.5 Source-Specific Recalculations

The indirect CO₂ emissions due to atmospheric decomposition of NMVOC from source category 3 Solvent and Other Product Use was moved back from chapter 9 into chapter 5. For the rational behind this reallocation see last year's submission (OEP 2012b).

Due to the re-allocation, recalculations have been done on the whole time series.

5.4.6 Source-Specific Planned Improvements

No source-specific improvements are planned.

5.5 Source Category 3D – Other

5.5.1 Source Category Description

Source category 3D comprises emissions from many different solvent applications. Besides NMVOC also emissions of N₂O are relevant. Also, it includes direct CO₂ emissions resulting from post-combustion of NMVOC to reduce NMVOC in exhaust gases as well as indirect CO₂ emission due to atmospheric decomposition of NMVOC.. Direct emissions of greenhouse gases result from the application of N₂O in households and hospitals and the emissions of CO₂ from the use of fireworks

Table 5-8 Specification of source category 3D "Other".

	Source	Specification	Data Source
3D	Other	Use of spray cans in industry and households; domestic solvent use application of glues and adhesives; use of concrete additives; removal of paint and lacquer; car underbody sealant; use of cooling lubricants and other lubricants; use of pesticides; use of pharmaceutical products in households; house cleaning industry/craft/services; hairdressers; scientific laboratories; industrial production; cosmetic institutions; use of tobacco products; wood preservation; medical practitioners; other health care institutions; no-attributable solvent emissions; use of N ₂ O in households and in hospitals; other use of gases; use of fireworks	AD: OS 2012c EF: FOEN 2012

5.5.2 Methodological Issues

5.5.2.1 Methodology

Data availability in Liechtenstein is very limited. In order to establish rough estimates of emissions for Liechtenstein, the specific emissions per inhabitant in Switzerland are used as a proxy:

Emissions from the source category 3D in Liechtenstein are the product of the specific emissions per inhabitant in Switzerland and the number of inhabitants in Liechtenstein.¹²

This basis allows a first preliminary estimate of emissions. The rationale behind this simple approach is that the general characteristics of Liechtenstein and Switzerland determining emissions are mainly similar.

5.5.2.2 Emission Factors

Emission factors for NMVOC, CO₂ and N₂O, which is the specific emissions per inhabitant, are calculated by dividing the emissions from source category 3D from the Swiss national inventory (FOEN 2012) by the number of inhabitants in Switzerland (see Table 4-3 in section 4.2.2).

¹² This approach is used for all years except the latest (2011). Here, for Liechtenstein the specific emission factor of Switzerland of the previous year (2010) are used, because the Swiss National Inventory is published only after the drafting of Liechtenstein's NIR. For the next submission, the emission factors used for Liechtenstein will be updated according to the latest Swiss NIR.

Table 5-9 Emission factors - specific emissions per inhabitant 1990 to 2011 (Source: Swiss emissions from FOEN 2012; inhabitants see Section 4.2.2).

Source	Unit	1990	1991	1992	1993	1994	1995	1996	1997	1998	1999
3D1. Other. Use of N₂O for Anaesthesia											
N ₂ O	g/inhabitant	43	40	38	35	32	30	27	25	22	19
3D3. Other. N₂O from Aerosol Cans											
N ₂ O	g/inhabitant	9	9	9	9	10	10	10	10	10	10
3D5. Other. Other. Spray cans, cosmetic institutions, etc.											
CO ₂	g/inhabitant	23'257	22'254	21'568	20'725	20'266	19'685	18'873	17'901	16'993	16'044
NMVOC	g/inhabitant	8'809	8'250	7'770	7'328	6'892	6'462	6'047	5'642	5'239	4'826

Source	Unit	2000	2001	2002	2003	2004	2005	2006	2007	2008	2009
3D1. Other. Use of N₂O for Anaesthesia											
N ₂ O	g/inhabitant	17	14	13	13	12	12	13	13	13	13
3D3. Other. N₂O from Aerosol Cans											
N ₂ O	g/inhabitant	10	10	10	10	10	10	10	10	10	10
3D5. Other. Other. Spray cans, cosmetic institutions, etc.											
CO ₂	g/inhabitant	15'181	14'283	13'698	13'361	12'838	12'530	12'146	12'293	11'938	11'849
NMVOC	g/inhabitant	4'420	4'005	3'787	3'574	3'369	3'257	3'154	3'120	3'088	3'056

Source	Unit	2010	2011
3D1. Other. Use of N₂O for Anaesthesia			
N ₂ O	g/inhabitant	14	14
3D3. Other. N₂O from Aerosol Cans			
N ₂ O	g/inhabitant	10	10
3D5. Other. Other. Spray cans, cosmetic institutions, etc.			
CO ₂	g/inhabitant	11'999	11'999
NMVOC	g/inhabitant	3'032	3'032

5.5.2.3 Activity Data

The development of the number of inhabitants in Liechtenstein is provided in Section 4.2.2.

5.5.3 Uncertainties and Time-Series Consistency

The uncertainty of CO₂ emissions from the entire source category 3 Solvent and Other Product Use is estimated to be 80% (expert estimate based on uncertainty of Swiss data and uncertainty of simple approach).

For NMVOC emissions no uncertainty assessment is done according to the IPCC guideline.

The time series is consistent.

5.5.4 Source-Specific QA/QC and Verification

The source-specific QA/QC activities have been carried out as mentioned in sections 1.6.1.4 and 1.6.1.5 including also the triple check of the CRF tables (detailed comparison of latest with previous data for the base year, for 2010 and for the changing rates 2010/2011).

5.5.5 Source-Specific Recalculations

The indirect CO₂ emissions due to atmospheric decomposition of NMVOC from source category 3 Solvent and Other Product Use was moved back from chapter 9 into chapter 5. For the rationale behind this reallocation see last year's submission (OEP 2012b).

Due to the re-allocation, recalculations have been done on the whole time series.

5.5.6 Source-Specific Planned Improvements

No source-specific improvements are planned.

6 Agriculture

6.1 Overview

This chapter provides information on the estimation of the greenhouse gas emissions from the agriculture sector (Sectoral Report for Agriculture, Table 4 in the Common Reporting Format). The following source categories are reported:

- CH₄ emissions from enteric fermentation in domestic livestock,
- CH₄ and N₂O emissions from manure management,
- N₂O emissions from agricultural soils.

Total greenhouse gas emissions from agriculture in 2011 were 23.4 Gg CO₂ equivalents in total, which is a contribution of 10.5% to the total of Liechtenstein’s greenhouse gas emissions (excluding LULUCF). Main agricultural sources of greenhouse gases in 2011 were enteric fermentation emitting 10.7 Gg CO₂ equivalents, followed by agricultural soils with 9.2 Gg CO₂ equivalents. In general, emissions decreased until 2000 followed by an increase until 2007. 2008-2010 emissions show a slight decreasing trend. The 2011 figures do not continue this trend, with overall emissions increasing with respect to 2010. The overall emissions from agriculture in CO₂ equivalents in 2011 are slightly higher than in 1990 (+1.8%).

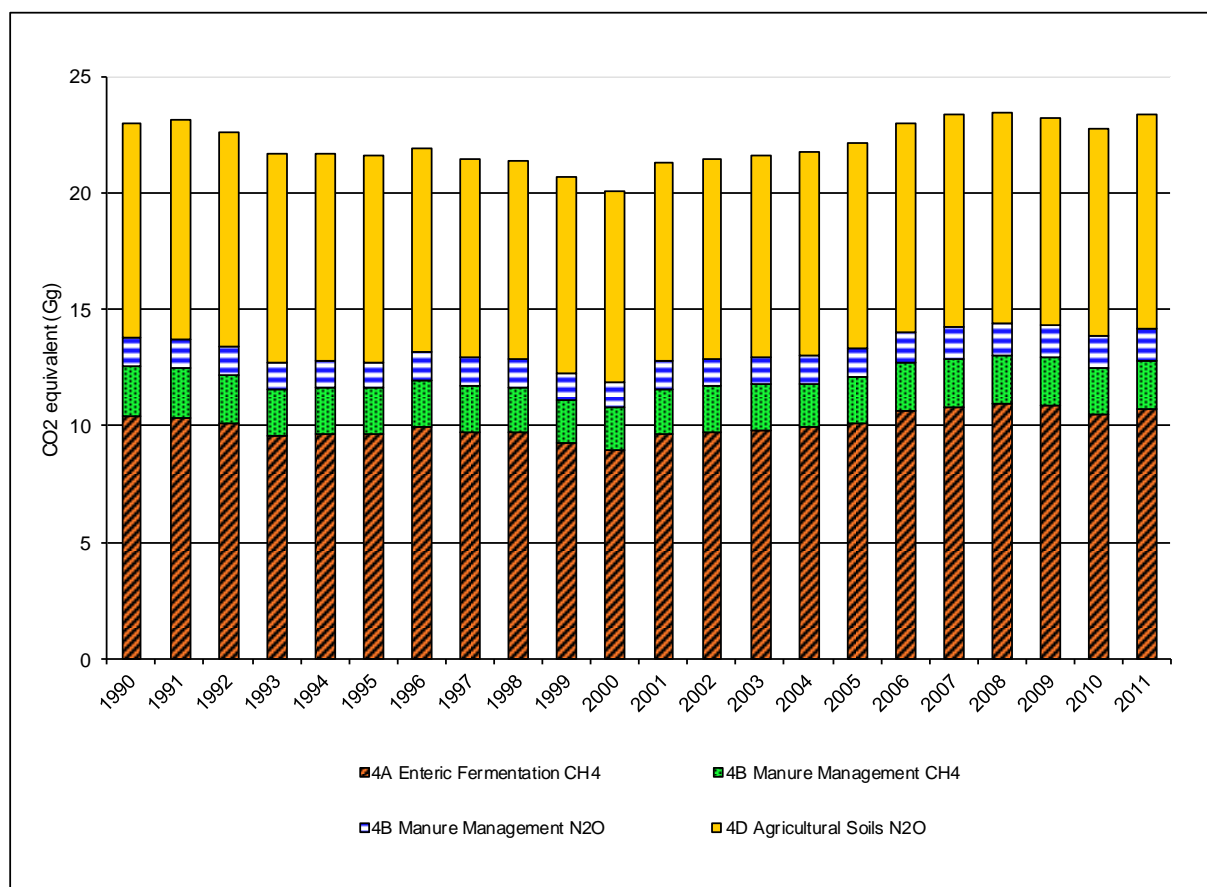

Figure 6-1 Greenhouse gas emissions in Gg CO₂ equivalents of agriculture 1990-2011.

No CO₂ emissions are reported in the agricultural sector. CO₂ emissions from energy use in agriculture are reported under Energy, Other Sectors (1A4c).

Table 6-1 Greenhouse gas emissions in Gg CO₂ equivalents of agriculture 1990-2011 (numbers may not add to totals due to rounding).

Gas	1990	1991	1992	1993	1994	1995	1996	1997	1998	1999
	CO ₂ equivalent (Gg)									
CH ₄	12.6	12.5	12.2	11.6	11.6	11.6	11.9	11.7	11.6	11.1
N ₂ O	10.4	10.6	10.5	10.1	10.1	10.0	10.0	9.8	9.7	9.5
Sum	23.0	23.1	22.6	21.6	21.7	21.6	21.9	21.5	21.3	20.6

Gas	2000	2001	2002	2003	2004	2005	2006	2007	2008	2009
	CO ₂ equivalent (Gg)									
CH ₄	10.8	11.6	11.7	11.7	11.8	12.1	12.7	12.9	13.0	12.9
N ₂ O	9.3	9.7	9.8	9.8	9.9	10.1	10.3	10.4	10.4	10.3
Sum	20.1	21.3	21.5	21.6	21.7	22.1	23.0	23.3	23.4	23.2

Gas	2010	2011	1990 - 2011
			%
CH ₄	12.5	12.7	1.3
N ₂ O	10.3	10.6	2.4
Sum	22.7	23.4	1.8

CH₄ emissions are now 1.3% higher than in 1990 in spite of a slight decrease in total cattle number – however, the number of mature cattle has increased compared to 1990 and so has the gross energy intake, leading to higher CH₄ emissions. N₂O emissions increased by 2.4% mainly due to the increase of mature non-dairy cattle, which leads to higher N₂O emissions from pasture soils. Until 2000 CH₄ and N₂O have decreased significantly, since then they have increased again, reaching or exceeding almost the level of 1990 in recent years. Main driver of this phenomenon is the development of the animal populations (see also Figure 6-5).

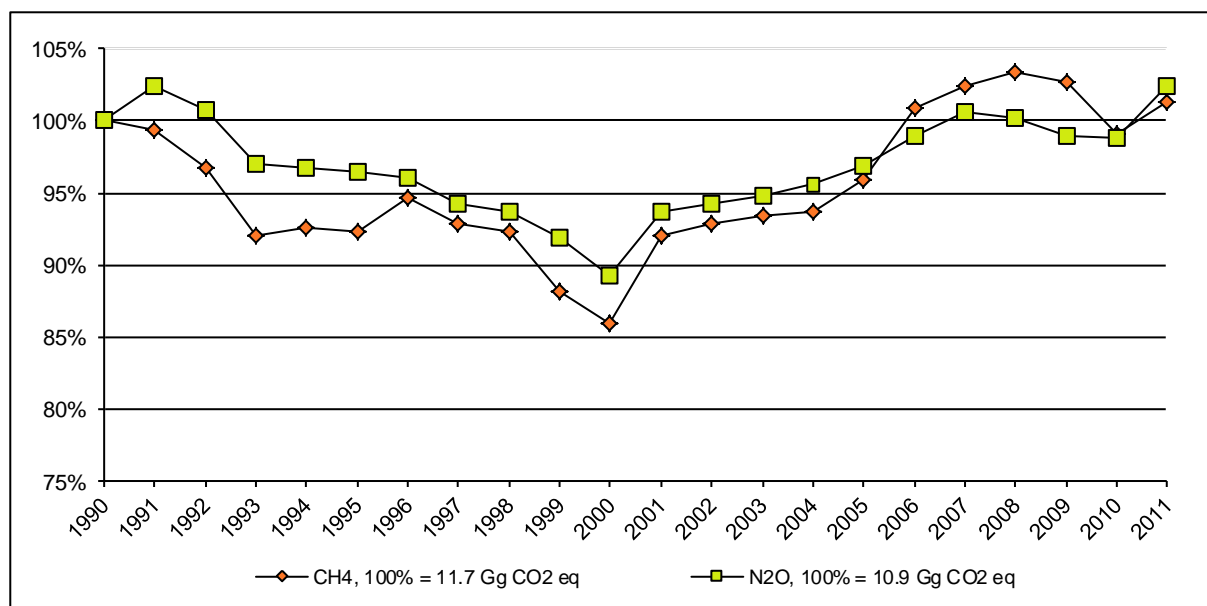

Figure 6-2 Trend of greenhouse gases of the agricultural sector 1990-2011. The base year 1990 represents 100%.

Four key sources of the inventory are from the agricultural sector: CH₄ emissions from enteric fermentation, CH₄ emissions from manure management, direct N₂O emissions from agricultural soils and indirect N₂O emissions from agricultural soils.

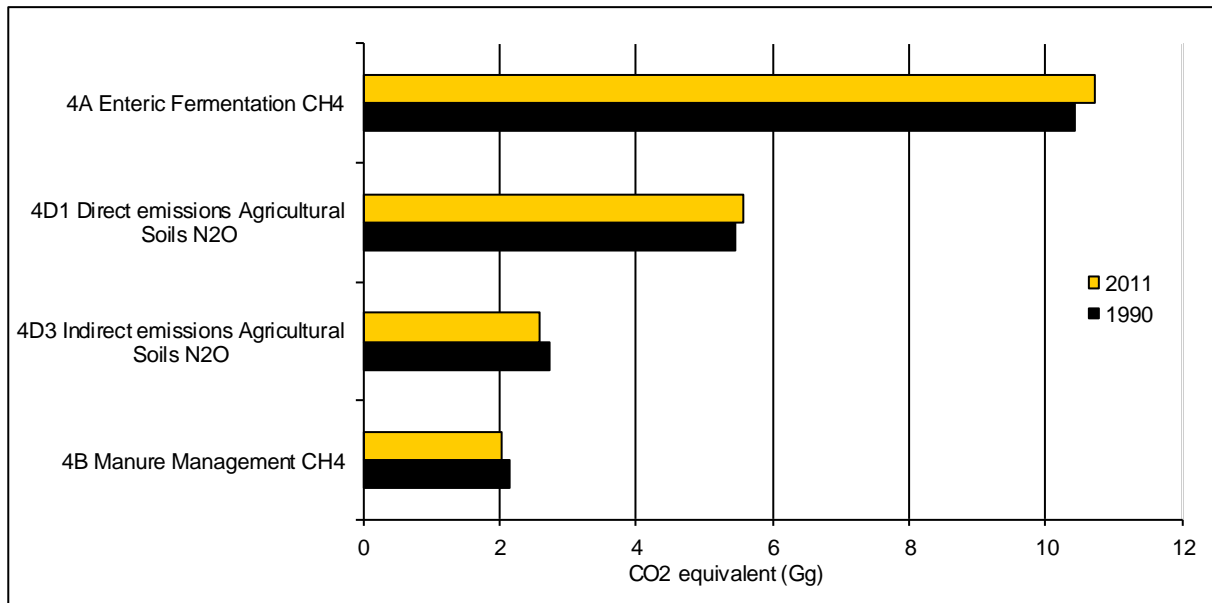

Figure 6-3 Key sources in agriculture. Emissions in CO₂ equivalents (Gg) per key source category in 2011 and in the base year 1990.

6.2 Source Category 4A – Enteric Fermentation

6.2.1 Source Category Description

Key source 4A

The CH₄ emissions from 4A Enteric Fermentation are a key source by level.

CH₄ emissions from enteric fermentation have decreased until 2000 and since then increased again to about the same level as 1990. They are basically following the cattle population number, as emissions from cattle contribute to 90% of the enteric fermentation emissions. A second development, the increasing productivity of the dairy cattle (high-yield cattle), results in a higher (per animal) emission factor and strengthens the increase in emissions after 2000.

Table 6-2 Specification of source category 4A "Enteric Fermentation". AD: activity data; EF: emission factors.

4A	Source	Specification	Data Source
4A1	Cattle	Mature dairy cattle	AD: Livestock data from OFIVA/OA 2012 (since 2002), OA 2002 (before 2002) Net energy and metabolisable energy (calves) from RAP 1999. Categories according to Flisch et. al 2009 EF: Soliva 2006a
		Mature non-dairy cattle	
		Fattening Calves, Pre-Weaned Calves, Breeding Cattle 1 st , 2 nd , 3 rd Year, Fattening cattle	
4A3 4A4	Sheep Goats		AD: Livestock data from OFIVA/OA 2012 (since 2002), OA 2002 (before 2002) Data on net energy and feed intake losses from SBV 2006 EF: Soliva 2006a
4A6 4A8	Horses Swine		AD: Livestock data from OFIVA/OA 2012 (since 2002), OA 2002 (before 2002) Data on digestible energy and feed intake losses from SBV 2006 EF: Soliva 2006a
4A7	Mules and asses		AD: Livestock data from OFIVA/OA 2012 (since 2002), OA 2002 (before 2002) Data on digestible energy and feed intake losses from SBV 2006 EF: Soliva 2006a
4A9	Poultry		AD: Livestock data from OFIVA/OA 2012 (since 2002), OA 2002 (before 2002) Data on metabolisable energy and feed intake losses from SBV 2006 EF: Hadorn and Wenk 1996 cited in Soliva 2006a.

6.2.2 Methodological Issues

6.2.2.1 Methodology

Liechtenstein adopted the Swiss calculation methodology, Tier 2, for CH₄ emissions in agriculture by applying the same calculation and therefore the same values for the gross energy intake (except for dairy and young cattle which are Liechtenstein specific) and by adjusting the activity data.

The following paragraph gives some further explanations about the Swiss calculation of CH₄ emissions from enteric fermentation (*excerpt from NIR CH, chpt. 6.2.2, FOEN 2012*):

The calculation is based on methods described in the IPCC Good Practice Guidance (IPCC 2000, equation 4.14). CH₄ emissions from enteric fermentation of the livestock population have been estimated using Tier 2 methodology. This means that detailed country specific data on nutrient requirements, feed intake and CH₄ conversion rates for specific feed types are required.

*For calculating the **gross energy intake** a country specific method based on available data on net energy (lactation, growth), digestible energy and metabolisable energy has been*

applied. Data on energy intakes are taken from SBV 2009 and from RAP 1999. The method is described in detail in Soliva 2006a and is realised in ART.

Different energy levels (Figure 6-4) are used to express the energy conversion from energy intake to the energy required for maintenance and performance.

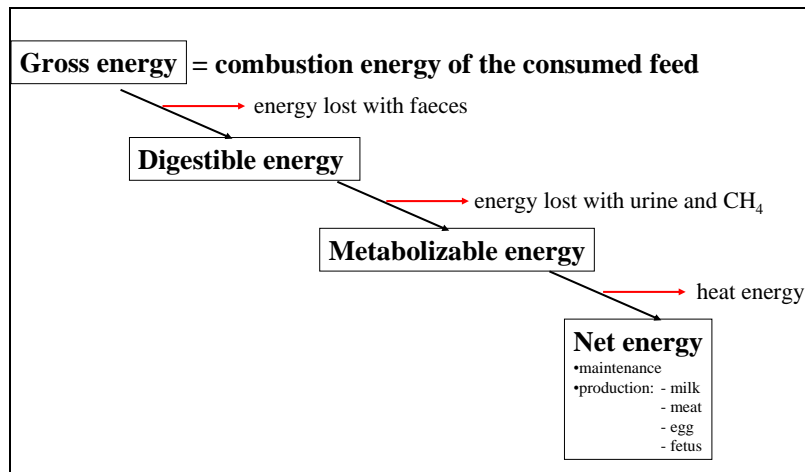

Figure 6-4 Levels of feed energy conversion. Reference: Soliva 2006a.

Net energy (NE) is used to express the energy required by the ruminants such as cattle, sheep and goats. NE in cattle feeding is further sub-divided into NE for lactation (NEL) and NE for growth (NEV). For some of the young cattle categories NEL is used rather than NEV what would seem natural. However, cattle raising is often coupled with dairy cattle activities and therefore the same energy unit (NEL) is used in these cases (RAP 1999). Exceptions are the fattening calves (milk-fed calves), whose requirements for energy are expressed as metabolisable energy (ME). Horses, mules, asses and swine are fed on the basis of digestible energy (DE), whereas poultry are fed according to metabolisable energy (ME).

In the energy estimation also some feed energy losses are integrated. Feed losses are defined as the feed not eaten by the animal and therefore represent a loss of net energy.

For the cattle categories detailed estimations for NE are necessary. As the Swiss Farmers Union (SBV) does not calculate the NE for detailed cattle source categories, NE data for each cattle subcategory was calculated individually according to the animal's requirements following the feeding recommendations of RAP (1999). These RAP recommendations are also used by the Swiss farmers as basis for their cattle feeding regime and for filling in application forms for subsidies for ecological services, and are therefore highly appropriate. In the calculation of the NE data, the animal's weight, daily growth rate, daily feed intake (dry matter), daily feed energy intake, and energy required for milk production for the respective source categories were considered (Soliva 2006a).

6.2.2.2 Emission factors

All emission factors for enteric fermentation are country specific emission factors of Switzerland from the year 2011. They are based on IPCC equation 4.14 IPCC 2000, p. 4.26.

$$EF = \frac{GE * Y_m * 365 \text{ days} / y}{55.65 \text{ MJ} / \text{kg} \text{ CH}_4}$$

GE: Gross energy intake

Y_m = Methane conversion rate, which is the fraction of gross energy in food converted to CH_4

55.65 MJ/kg = energy content of methane. The following calculated gross energy intakes are used:

Table 6-3 Gross energy intake of different livestock groups. Calculation is based on the above mentioned parameters net energy, digestible energy, metabolisable energy according to the method described in FOEN 2012 and Soliva 2006a. Input data on net energy, digestible energy and metabolisable energy is taken from SBV 2009 and RAP 1999. Mature dairy cattle are variable in time due to their dependency on milk production. All sub-source categories displayed in italic.

Gross Energy intake		1990-1999									
		1990	1991	1992	1993	1994	1995	1996	1997	1998	1999
		MJ/head/day									
Cattle											
	Mature dairy cattle	282.1	282.6	284.3	285.5	281.7	283.7	284.1	287.9	290.6	292.0
	Mature non-dairy cattle	205.1	205.1	205.1	205.1	205.1	205.1	205.1	205.1	205.1	205.1
	Young cattle average	101.8	102.0	101.7	101.0	99.1	99.4	99.5	97.8	97.7	94.2
	<i>Fattening Calves</i>	47.6	47.6	47.6	47.6	47.6	47.6	47.6	47.6	47.6	47.6
	<i>Pre-Weaned Calves</i>	55.7	55.7	55.7	55.7	55.7	55.7	55.7	55.7	55.7	55.7
	Sheep	22.6	22.6	22.6	22.6	22.6	22.6	22.6	22.6	22.6	22.6
	Goats	31.4	31.4	31.4	31.4	31.4	31.4	31.4	31.4	31.4	31.4
	Horses	137.4	137.4	137.4	137.4	137.4	137.4	137.4	137.4	137.4	137.4
	Mules and Asses	100.2	100.2	100.2	100.2	100.2	100.2	100.2	100.2	100.2	100.2
	Swine	35.1	35.1	35.1	35.1	35.1	35.1	35.1	35.1	35.1	35.1
	Poultry 1)	1.2	1.2	1.2	1.2	1.2	1.2	1.2	1.2	1.2	1.2

1) Poultry data is not Gross Energy (GE) intake but Metabolizable Energy intake (ME)

Gross Energy intake		2000-2009									
		2000	2001	2002	2003	2004	2005	2006	2007	2008	2009
		MJ/head/day									
Cattle											
	Mature dairy cattle	296.4	303.6	305.5	306.3	311.4	308.9	307.9	307.6	309.3	304.4
	Mature non-dairy cattle	205.1	205.1	205.1	205.1	205.1	205.1	205.1	205.1	205.1	205.1
	Young cattle average	99.8	97.2	100.6	99.7	96.9	97.4	96.7	94.7	95.3	96.3
	<i>Fattening Calves</i>	47.6	47.6	47.6	47.6	47.6	47.6	47.6	47.6	47.6	47.6
	<i>Pre-Weaned Calves</i>	55.7	55.7	55.7	55.7	55.7	55.7	55.7	55.7	55.7	55.7
	Sheep	22.6	22.6	22.6	22.6	22.6	22.6	22.6	22.6	22.6	22.6
	Goats	31.4	31.4	31.4	31.4	31.4	31.4	31.4	31.4	31.4	31.4
	Horses	137.4	137.4	137.4	137.4	137.4	137.4	137.4	137.4	137.4	137.4
	Mules and Asses	100.2	100.2	100.2	100.2	100.2	100.2	100.2	100.2	100.2	100.2
	Swine	35.1	35.1	35.1	35.1	35.1	35.1	35.1	35.1	35.1	35.1
	Poultry 1)	1.2	1.2	1.2	1.2	1.2	1.2	1.2	1.2	1.2	1.2

Gross Energy intake		2010-2011	
		2010	2011
Cattle			
	Mature dairy cattle	305.8	307.7
	Mature non-dairy cattle	205.1	205.1
	Young cattle average	97.6	96.9
	<i>Fattening Calves</i>	47.6	47.6
	<i>Pre-Weaned Calves</i>	55.7	55.7
	Sheep	22.6	22.6
	Goats	31.4	31.4
	Horses	137.4	137.4
	Mules and Asses	100.2	100.2
	Swine	35.1	35.1
	Poultry 1)	1.2	1.2

The gross energy intake per head for mature dairy cattle follows the development of the milk production per head and therefore increased until 2004 mainly as a result of higher milk production (see Table 6-4). The gross energy intake of young cattle was calculated

separately for all source categories (Breeding Cattle 1st, 2nd, 3rd Year, Fattening Cattle, Fattening Calves, Pre-Weaned Calves) and subsequently averaged. Not all these source categories are displayed in Table 6-3. The values for all source categories summarized under young cattle are constant over time but since the composition of the young cattle category is changing over time, the average gross energy intake for young cattle is changing over time. The gross energy intake for mature non-dairy cattle is significantly higher than IPCC default values, since this category only consists of mature cows producing offspring for meat. Milk production of mature non-dairy cattle is 2500kg per head and year and does not change over the inventory time period (RAP 1999).

The energy intake for all other categories is estimated to be constant.

Statistics of annual milk production in Table 6-4 are from OFIVA/OA 2012 and form the basis for the calculation of the GEI of dairy cattle.

Table 6-4 Population size, lactation period and milk yield per animal 1990-2011

Milk production mature dairy cattle		1990	1991	1992	1993	1994	1995	1996	1997	1998	1999
Population size mature dairy cattle	head	2'850	2'843	2'747	2'601	2'677	2'643	2'652	2'622	2'614	2'589
Lactation period	day	305	305	305	305	305	305	305	305	305	305
Milk yield mature dairy cattle	kg/head/day	18.99	19.05	19.26	19.41	18.94	19.19	19.23	19.70	20.02	20.19
Milk yield mature non-dairy cattle	kg/head/day	8.20	8.20	8.20	8.20	8.20	8.20	8.20	8.20	8.20	8.20

Milk production mature dairy cattle		2000	2001	2002	2003	2004	2005	2006	2007	2008	2009
Population size mature dairy cattle	head	2'440	2'639	2'560	2'543	2'460	2'489	2'589	2'593	2'579	2'565
Lactation period	day	305	305	305	305	305	305	305	305	305	305
Milk yield mature dairy cattle	kg/head/day	18.99	21.60	21.83	21.93	22.54	22.24	22.11	22.09	22.29	21.70
Milk yield mature non-dairy cattle	kg/head/day	8.20	8.20	8.20	8.20	8.20	8.20	8.20	8.20	8.20	8.20

Milk production mature dairy cattle		2010	2011
Population size mature dairy cattle	head	2'425	2'435
Lactation period	day	305	305
Milk yield mature dairy cattle	kg/head/day	21.87	22.09
Milk yield mature non-dairy cattle	kg/head/day	8.20	8.20

For the **methane conversion rate Y_m** (%) only limited country specific data exists. Therefore default values recommended by the IPCC for developed countries in Western Europe were used (IPCC 1997b: Reference Manual: p. 4.32–4.35 and IPCC 2000: p. 4.27). For poultry a Swiss country specific value ($Y_{\text{poultry}} = 0.1631$) was used since no default value is given by the IPCC. This value was evaluated in an in vivo trial with broilers (Hadorn and Wenk 1996).

6.2.2.3 Activity data

The activity data input has been obtained from Liechtenstein's Office for Food-control and Veterinary (Amt für Lebensmittelkontrolle und Veterinärwesen) in cooperation with the Office for Agriculture (OFIVA/OA 2011 and OFIVA/OA 2012, for all years since 2002) and from the Office of Agriculture (OA 2002, for the years before 2002). Data for the livestock categories Mature Dairy Cattle, Sheep, Goats and Swine are available annually for the whole time series. For all the other livestock categories and their source categories, data from the years 1990 and 2000, and from 2002 onward is available. Data in between was interpolated. From 2002 onward, data for all livestock categories is available on an annual basis.

Table 6-5 Activity Data for Liechtenstein (OFIVA/OA 2011, OFIVA/OA 2012, OA 2002). Head numbers are used to calculate CH₄ emissions, while animal place numbers are used to calculate N₂O emissions.

Population Size		1990	1991	1992	1993	1994	1995	1996	1997	1998	1999
		Head/Places									
Fattening Calves	places	50	56	62	69	75	81	87	93	100	106
Pre-Weaned Calves	head	15	18	23	26	31	35	38	43	46	51
Breeding Cattle 1st Year	head	1'136	1'027	1'020	935	1'030	1'057	994	1'011	917	965
Breeding Cattle 2nd Year	head	903	815	794	694	668	699	719	627	572	513
Breeding Cattle 3rd Year	head	631	619	632	572	509	575	494	460	457	360
Fattening Cattle	places	723	801	704	742	812	725	869	822	720	440
Young Cattle	head	3'458	3'336	3'235	3'038	3'125	3'172	3'201	3'056	2'812	2'435
Mature Dairy Cattle	head	2'850	2'843	2'747	2'601	2'677	2'643	2'652	2'622	2'614	2'589
Mature Non-Dairy Cattle	head	20	25	31	36	42	47	52	58	63	69
Total Cattle	head	6'328	6'204	6'013	5'675	5'844	5'862	5'905	5'736	5'489	5'093
Fattening Sheep	places	1636	1765	1755	1685	1551	1'079	2'127	2'114	2'240	2'108
Milksheep	places	0	0	0	0	0	0	0	0	0	0
Total Sheep	head	2'781	2'689	2'878	2'641	2'627	2'632	3'352	3'234	3'608	3'264
Goat Places	places	111	154	179	103	84	100	197	193	209	190
Total Goats	head	171	213	277	181	136	145	275	269	287	313
Horses <3 years	head	33	32	30	29	28	27	25	24	23	21
Horses >3 years	head	133	133	134	134	134	135	135	135	135	136
Total Horses	head	166	165	164	163	162	162	160	159	158	157
Total Mules and Asses	head	73	71	85	113	111	133	159	166	184	197
Piglets	places	506	495	484	474	463	452	441	430	420	409
Fattening Pig over 25 kg	places	1'006	1'251	978	791	1'080	1'091	253	151	161	151
Dry Sows	places	207	298	245	173	154	191	120	282	192	233
Nursing Sows	places	66	96	79	55	50	62	38	91	62	75
Boars	head	5	5	5	5	5	5	4	4	4	4
Total Swine	head	3'251	3'543	2'902	3'236	2'787	2'429	2'392	2'128	2'056	2'122
Growers	places	105	95	84	74	63	53	42	32	21	11
Layers	places	4'145	4'417	4'689	4'961	5'233	5'506	5'778	6'050	6'322	6'594
Broilers	places	0	100	200	300	400	500	600	700	800	900
Turkey	places	22	29	35	42	48	55	61	68	74	81
Other Poultry (Geese, Ducks, Ostriches,	places	163	157	152	146	140	134	129	123	117	111
Total Poultry	head	4'435	4'798	5'160	5'523	5'884	6'248	6'610	6'973	7'334	7'697

Population Size		2000	2001	2002	2003	2004	2005	2006	2007	2008	2009
		Head/Places									
Fattening Calves	places	112	92	71	89	87	83	63	106	80	104
Pre-Weaned Calves	head	11	56	101	141	252	266	283	339	341	294
Breeding Cattle 1st Year	head	649	746	645	595	630	601	717	688	724	723
Breeding Cattle 2nd Year	head	544	510	626	631	605	676	668	683	659	727
Breeding Cattle 3rd Year	head	343	358	413	383	384	348	398	315	372	372
Fattening Cattle	places	774	496	659	707	776	743	703	839	838	860
Young Cattle	head	2'433	2'258	2'515	2'546	2'734	2'717	2'832	2'970	3'014	3'080
Mature Dairy Cattle	head	2'440	2'639	2'560	2'543	2'460	2'489	2'589	2'593	2'579	2'565
Mature Non-Dairy Cattle	head	74	112	149	199	279	362	405	466	454	433
Total Cattle	head	4'947	5'009	5'224	5'288	5'473	5'568	5'826	6'029	6'047	6'078
Fattening Sheep	places	1'522	2'117	1'681	1'697	1'911	2'005	2'049	2'064	2'090	2'081
Milksheep	places	0	0	0	0	0	41	51	0	0	0
Total Sheep	head	2'983	3'319	3'116	3'070	3'149	3'063	3'687	3'683	3'850	3'963
Goat Places	places	96	147	129	130	155	171	198	179	251	266
Total Goats	head	164	210	205	241	286	324	362	319	425	452
Horses <3 years	head	20	12	4	11	24	28	32	28	24	30
Horses >3 years	head	136	162	187	196	230	237	253	249	277	282
Total Horses	head	156	174	191	207	254	265	285	277	301	312
Total Mules and Asses	head	223	250	153	140	160	144	141	164	193	189
Piglets	places	398	322	246	268	7	222	267	192	218	147
Fattening Pig over 25 kg	places	1'229	103	1'506	1'484	962	1'162	1'019	1'125	1'098	1'179
Dry Sows	places	91	217	85	102	5	96	76	78	79	98
Nursing Sows	places	22	70	21	15	3	21	32	29	29	29
Boars	head	4	4	4	3	1	3	4	3	4	3
Total Swine	head	1'992	2'248	2'101	2'029	990	1'703	1'723	1'735	1'758	1'811
Growers	places	0	0	0	11	9	0	9	1	48	0
Layers	places	6'866	8'450	10'034	10'113	10'549	10'112	11'398	11'357	11'766	11'650
Broilers	places	1'000	625	250	250	520	250	300	702	350	350
Turkey	places	87	94	100	34	52	52	35	164	15	3
Other Poultry (Geese, Ducks, Ostriches,	places	106	100	0	2	25	39	127	166	229	165
Total Poultry	head	8'059	9'269	10'384	10'410	11'155	10'453	11'869	12'390	12'408	12'168

(Cont'd from previous page)

Population Size		2010	2011
Fattening Calves	places	81	82
Pre-Weaned Calves	head	281	329
Breeding Cattle 1st Year	head	814	821
Breeding Cattle 2nd Year	head	808	814
Breeding Cattle 3rd Year	head	459	462
Fattening Cattle	places	743	763
Young Cattle	head	3'186	3'271
Mature Dairy Cattle	head	2'425	2'435
Mature Non-Dairy Cattle	head	382	448
Total Cattle	head	5'993	6'154
Fattening Sheep	places	2'061	2'102
Milksheep	places	0	0
Total Sheep	head	3'656	3'656
Goat Places	places	253	255
Total Goats	head	434	462
Horses <3 years	head	31	31
Horses >3 years	head	304	301
Total Horses	head	335	332
Total Mules and Asses	head	154	191
Piglets	places	301	143
Fattening Pig over 25 kg	places	1'058	1'152
Dry Sows	places	101	89
Nursing Sows	places	18	31
Boars	head	3	5
Total Swine	head	1'690	1'690
Growers	places	61	25
Layers	places	12'175	11'862
Broilers	places	390	362
Turkey	places	103	42
Other Poultry (Geese, Ducks, Ostriches)	places	191	203
Total Poultry	head	12'920	12'494

The number of sheep, goats and horses increased between 1990 and 2011.

The massive increase in the poultry population is a result of two new poultry farms that were established in Liechtenstein but seem to have reached a stable population since 2007.

The drastic decrease of the swine population between 2003 and 2004 was caused by a disease, since 2005 the number of swine remains rather constant.

Total number of cattle decreased by 22% between 1990 and the beginning of the new millennium, but grew again between 2000 and 2007; from 2007 to 2011 it has stabilised at a slightly lower level than 1990. Mature non-dairy cattle (mature cows used to produce offspring for meat) have continuously grown in number (from 20 heads in 1990 to 448 heads in 2011), as this form of meat production and cattle breeding is relatively new.

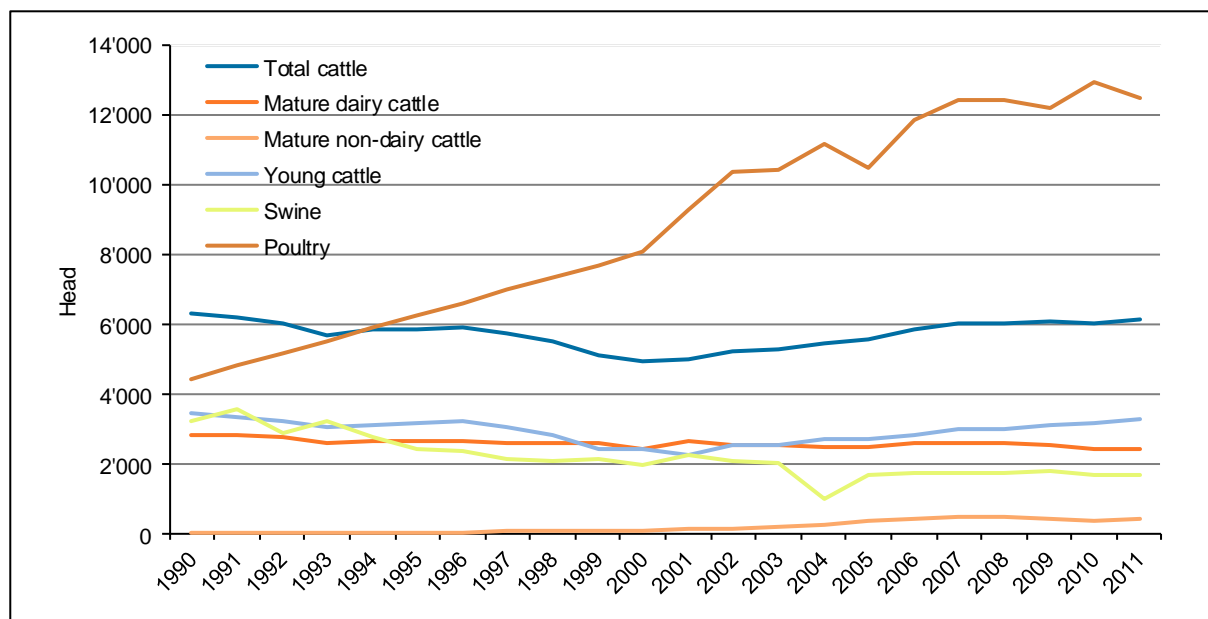

Figure 6-5 Development of population size of main animal categories 1990-2011 (OFIVA/OA 2011, OFIVA/OA 2012)

6.2.3 Uncertainties and Time-Series Consistency

For the uncertainty analysis the following input data from the Swiss Agroscope Reckenholz-Tänikon Research Station ART was used (ART 2008). It is assumed that uncertainty estimations from Switzerland are also applicable for Liechtenstein. Liechtenstein applies the same methods and emission factors and has a similar sophisticated livestock data collection system with low inaccuracies.

Table 6-6 Input data for the uncertainty analysis of the source category 4A "Enteric Fermentation" (ART 2008).

Input data for uncertainty analysis 4A	Lower bound (2.5 Percentile)	Upper bound (97.5 Percentile)	Mean uncertainty
Activity data (head)	-6.4%	+6.4%	±6.4%
Emission factor (kg CH ₄ /head/yr)	-14.7%	+19.6%	±17.2%

To apply for the Tier 1 uncertainty analysis, the arithmetic mean of lower and upper bound is used for activity data and for emission factors. For further results see Section 1.7.

Time series between 1990 and 2010 is consistent.

6.2.4 Source-Specific QA/QC and Verification

As mentioned in sections 1.6.1.4 and 1.6.1.5, the triple check of the CRF tables (detailed comparison of latest with previous data for the base year, for 2010 and for the changing rates 2010/2011) has been executed.

Documentation of the calculation method adapted from Switzerland ensures transparency and retraceability of the calculation methods and data sources (OEP 2011b, FOEN 2012). A quality control was done by Acontec and INFRAS by a countercheck of the calculation sheets.

The SE, the NIC and the NIR author report their QC activities in a checklist (see Annex 8).

6.2.5 Source-Specific Recalculations

For 2010, the difference is 0.03 Gg CO₂ eq (+0.27%) compared to the figure for the same year in Submission 2012. It is due to updated data on milk production per head of mature dairy cattle, which had been estimated based on 2009 data for the 2012 submission (since the data for 2010 were not yet available at the time).

6.2.6 Source-Specific Planned Improvements

There are no further source-specific improvements planned.

6.3 Source Category 4B – Manure Management

6.3.1 Source Category Description

Key source 4B

The CH₄ emissions from 4B Manure Management are a key source by level. N₂O emissions are not a key source.

CH₄ and N₂O emissions from manure management 2011 are 0.8% higher than the emissions in 1990. The emissions of manure management follow closely the development of the cattle population.

Table 6-7 Specification of source category 4B “Manure Management (CH₄)”. AD: Activity data; EF: Emission factors.

4B	Source	Specification	Data Source
4B1	Cattle	Mature dairy cattle	AD: OFIVA/OA 2012, OFIVA/OA 2011 (since 2002), OA 2002 (before 2002)
		Mature non-dairy cattle	
		Fattening Calves, Pre-Weaned Calves, Breeding Cattle 1st, 2nd, 3rd Year, Fattening cattle	EF: IPCC 2000; IPCC 1997c; Soliva 2006a; Flisch et al. 2009; Agrammon 2010;
4B3 4B4 4B6 4B8	Sheep Goats Horses Swine		AD: OFIVA/OA 2012, OFIVA/OA 2011 (since 2002), OA 2002 (before 2002) EF: IPCC 2000; IPCC 1997c; Soliva 2006a; Flisch et al. 2009; Agrammon 2010;
4B7	Mules and Asses		AD: OFIVA/OA 2012, OFIVA/OA 2011 (since 2002), OA 2002 (before 2002) EF: IPCC 2000; IPCC 1997c; Soliva 2006a; Flisch et al. 2009; Agrammon 2010;
4B9	Poultry		AD: OFIVA/OA 2012, OFIVA/OA 2011 (since 2002), OA 2002 (before 2002) EF: IPCC 2000; IPCC 1997c; Soliva 2006a; Flisch et al. 2009; Agrammon 2010;

Table 6-8 Specification of source category 4B "Manure Management (N₂O)". AD: Activity data; EF: Emission factors.

4B	Source	Specification	Data Source
4B11 4B12	Liquid Systems Solid storage and dry lot		AD: : OFIVA/OA 2012, OFIVA/OA 2011 (since 2002), OA 2002 (before 2002); Flisch et. al 2009; Agrammon 2010. EF: IPCC 2000; IPCC 1997c

6.3.2 Methodological Issues

Liechtenstein adopted the Swiss calculation methodology, Tier 2, for emissions from manure management by adjusting the activity data.

For calculation of CH₄ and N₂O emissions, slightly different livestock source categories are used. The livestock categories reported in the CRF tables are the same, but the respective source categories as a basis for the calculation are slightly different. Nevertheless there is no inconsistency in the total number of animals as they are the same both for CH₄ and N₂O emissions.

Calculation of CH₄ emissions of enteric fermentation is based on the head number of the livestock, while calculation of N₂O emissions is based on a slightly different livestock population breakdown based on animal places (see Table 6-5).

The following paragraph gives some further explanations about the reason for the Swiss specific calculation of N₂O emissions from manure management (*excerpt from NIR CH, chpt. 6.3.2, FOEN 2012*):

This calculation is chosen because more detailed data on N excretion for the particular animal categories are available (Flisch et al. 2009, Agrammon 2010). The nitrogen excretion rates are given on a yearly basis, considering replacement of animals (young cattle, swine and poultry) and including excretions from corresponding offsprings and other associated animals (sheep, goats, swine).

6.3.2.1 CH₄ Emissions

a) Methodology

Calculation of CH₄ emissions from manure management is based on IPCC Tier 2 (IPCC 2000, equation 4.17).

$$EF_i = VS_i \cdot 365 \text{ days / year} \cdot Bo_i \cdot 0.67 \text{ kg / m}^3 \cdot \sum_{ijk} MCF_{jk} \cdot MS_{ijk}$$

EF_i: annual emission factor for livestock population i

VS_i: daily VS excreted for an animal within population i

Bo_i: maximum CH₄ producing capacity for manure produced by an animal within population i

MCF_{jk}: CH₄ conversion factors for each manure management system j by climate region k

MS_{ijk}: fraction of animal species / category i's manure handled using manure system j in climate region k.

b) Emission factor

Calculation of the emission factor is based on the parameters volatile substance excreted (VS), the maximum CH₄ producing capacity for manure (B₀) and the CH₄ conversion factors for each manure management system (MCF).

VS & DE (digestible energy): No country specific values for the daily excretion of VS & DE are available.

The VS and DE for cattle source categories are taken from Switzerland and based on IPCC (2000: equation 4.16: p. 4.31). Gross energy intake is calculated according to the method described in Chapter 6.2.2. For the categories breeding cattle 1st year and fattening cattle the resulting values differ slightly from the values in Switzerland, as they are a weighted mean¹³ of the values of Swiss cattle subcategories (0-4 months and 5-12 months) as Liechtenstein's statistics do not contain this disaggregation level.

For the livestock categories swine, sheep, goats, horses, mules and asses, and poultry default values from IPCC 1997 (1997c: Reference Manual: p. 4.39 to 4.47) were taken.

The **ash content** of cattle manure is assumed to amount to 8% on average (IPCC 1997c: Reference Manual: p. 4.47).

B₀: For the Methane Producing Potential default values are used (IPCC 1997c: Reference Manual: p. 4.39 to 4.47).

MCF: For the Methane Conversion Factor IPCC default values are used (IPCC 2000, p. 4.36 and IPCC 1997c: Reference Manual: p. 4.25). In Liechtenstein mainly two manure management systems exist (AWMS), solid storage and liquid/slurry storage. However, the MCF's differ by animal species – there are specific MCF values for pasture and poultry systems. Calves are mainly kept in deep litter systems. The following MCF's were used:

Table 6-9 Manure management systems and Methane conversion factors (MCFs). References: IPCC 2000, p. 4.36 and IPCC 1997b: p. 4.25 (for liquid/slurry).

Manure management system	Description	MCF
Solid manure	Dung and urine are excreted in a barn. The solids (with and without litter) are collected and stored in bulk for a long time (months) before disposal.	1%
Liquid/slurry	Combined storage of dung and urine under animal confinements for longer than 1 month.	10%
Pasture	Manure is allowed to lie as it is, and is not managed (distributed, etc.).	1%
Deep litter	Dung and urine is excreted in a barn with lots of litter and is not removed for a long time (months). This is applied for the cattle source categories of milk-fed calves and fattening calves, and for sheep and goats.	10%
Poultry system	Manure is excreted on the floor with or without bedding.	1.5%

For the MCF for deep litter the 2000 IPCC good practice guidance suggest a value of 39%. However, this would lead to a rather large overestimation of methane emissions from deep litter manure management systems. Since the 2000 IPCC good practice guidance states that the MCF's for cattle and swine deep litter are similar to liquid/slurry, the respective value from the 1996 IPCC guidelines (IPCC 1997b) has been adopted. The choice of a MCF of 10% for deep litter is supported by a number of studies representative for the country specific management conditions (see Saturday Paper of Switzerland in Annex of FOEN 2011).

¹³ Weighted by days (e.g. breeding cattle: 120 days for breeding calves, 225 days for breeding cattle)

The fractions of animal's manure handled using different manure management systems (**MS**) as well as the grazing time for each livestock category are based on Switzerland's data from FOEN (2012), as the Swiss agriculture infrastructure is very similar to Liechtenstein's. The fractions for the year 2002 are applied constantly for the entire time series, as this was the year when Switzerland's extensive farm survey took place (Agrammon 2010). This approach with the constant value of 2002 seems to be justifiable, as the influence of the distribution to the different management systems on the total is negligible and no information on the development of the MS in Liechtenstein is available.

c) Activity data

Data on population sizes are taken from the Office of Food-control and Veterinary (OFIVA/OA 2011, 2012) and the Office of Agriculture (OA 2002). For details refer to Chapter 6.2.2.

6.3.2.2 N₂O Emissions

a) Methodology

Liechtenstein follows the Swiss approach for calculating N₂O emissions from manure management with LIE specific AD.

The Swiss methodology is explained in the following paragraph (*excerpt from NIR CH, chpt. 6.3.2, FOEN 2011*):

For the calculation of N₂O emissions from manure management a country specific method based on the new Swiss ammonia model AGRAMMON is applied (Agrammon 2010). Basically the IPCC emission factors are used, but activity data is adjusted to the particular situation of Switzerland.

For calculation of emissions from manure management AGRAMMON applies other values for the nitrogen excretion per animal category than IPCC and differentiates the animal waste management systems Liquid systems and Solid storage.

b) Emission factors

IPCC default emission factors are used for the two animal waste management systems occurring in Liechtenstein (IPCC 1997c: Reference Manual: p. 4.104). N₂O emissions from pasture, range and paddock appear under the category „4D: Agricultural soils“, subcategory 2 animal production. IPCC categories „daily spread“ and „other systems“ do not occur. The basic animal waste management systems are defined in Menzi et al. (1997). Please note that the categories “Solid manure”, “deep litter”, “poultry storage” and “pasture” in Table 6-9 all correspond to “Solid storage” in Table 6-10.

Table 6-10 Emission factors for calculating N₂O emissions from manure management (IPCC 1997c: p. 4.104).

Source	Emission factor per animal waste management system (kg N ₂ O-N / kg N)
Liquid systems	0.001
Solid storage	0.020

In particular the following values have been adopted from the Swiss Ammonia model Agrammon (2010) of the Swiss Inventory (FOEN 2012): MS_{Pasture}, MS_{Solid Storage}, MS_{Liquid System}, NH₃ Pasture, NH₃ Housing, NH₃ Storage, NH₃ Application.

c) Activity data

Input data on all livestock groups are taken from OFIVA/OA (2011, 2012) and OA 2002. Data are converted into numbers of animal places for certain livestock categories (see Table 6-5).

Except for dairy cattle, which is calculated based on country specific milk production data according to the methodology of Flisch et. al (2009), no national data on nitrogen excretion per animal category (kg N/head/year) is available in Liechtenstein. Therefore Swiss data is taken from the Swiss Ammonia model Agrammon (2010). Unlike IPCC, the age structure of the animals and the different use of the animals (e.g. fattening and breeding) are considered. Sheep are estimated to excrete approximately 8.0 kg N per head and year, which is considerably lower than IPCC default. However, nitrogen excretion is averaged over the whole population, of which roughly 50% are lambs and other immature animals. Furthermore, sheep are fed mainly according to a regime based on roughage from extensive pasture and meadows (Flisch et al. 2009). Swine show a significant decrease in nitrogen excretion per head which can be explained by the increasing use of protein reduced fodder.

The consideration of adopted nitrogen excretion values is one of the major advantages of the Swiss country specific method adopted in Liechtenstein's Inventory. The more disaggregated approach results in considerable lower calculated nitrogen excretion rates compared to IPCC, which therefore also implies lower total N₂O emissions from manure management.

Table 6-11 Nitrogen excretion per animal category (kg N/head/year) in five year steps 1990 -2010 (Agrammon 2010, except for dairy cattle).

Nitrogen excretion	1990-2010				
	1990	1995	2000	2005	2010
	kg N / head / year				
Cattle					
Mature dairy cattle	107.71	108.37	111.77	114.31	113.39
Mature non-dairy cattle	80.00	80.00	80.00	80.00	80.00
Young cattle	35.93	35.37	34.62	35.28	34.62
<i>Fattening Calves</i>	13.00	13.00	13.00	13.00	13.00
<i>Pre-Weaned Calves</i>	34.00	34.00	34.00	34.00	34.00
<i>Breeding Cattle 1st Year</i>	25.00	25.00	25.00	25.00	25.00
<i>Breeding Cattle 2nd Year</i>	40.00	40.00	40.00	40.00	40.00
<i>Breeding Cattle 3rd Year</i>	55.00	55.00	55.00	55.00	55.00
<i>Fattening Cattle</i>	33.00	33.00	33.00	33.00	33.00
Sheep	8.82	6.15	7.65	10.10	8.46
Fattening Sheep	15.00	15.00	15.00	15.00	15.00
Milk Sheep	21.00	21.00	21.00	21.00	21.00
Goats	10.39	11.03	9.37	8.44	9.33
Goat places	16.00	16.00	16.00	16.00	16.00
Horses	43.60	43.67	43.74	43.79	43.81
Horses < 3 years	42.00	42.00	42.00	42.00	42.00
Horses > 3 years	44.00	44.00	44.00	44.00	44.00
Mules and Asses	15.70	15.70	15.70	15.70	15.70
Swine	6.96	9.47	10.40	11.19	10.67
Piglets	4.63	4.63	4.63	4.63	4.63
Fattening Pig over 25 kg	13.00	13.00	13.00	13.00	13.00
Dry Sows	20.00	20.00	20.00	20.00	20.00
Nursing Sows	45.36	45.36	45.36	45.36	45.36
Boars	18.00	18.00	18.00	18.00	18.00
Poultry	0.70	0.68	0.68	0.71	0.70
Growers	0.34	0.34	0.34	0.34	0.34
Layers	0.71	0.71	0.71	0.71	0.71
Broilers	0.40	0.40	0.40	0.40	0.40
Turkey	1.40	1.40	1.40	1.40	1.40
Other Poultry (Geese, Ducks, Ostriches, Quails)	0.56	0.56	0.56	0.56	0.56

The split of nitrogen flows into the different animal waste management systems is the split occurring in the year 2002 in Switzerland according to latest Swiss Inventory (FOEN 2012) and based on Agrammon (2010). It is constant over time, due to the lack of specific data in Liechtenstein. This approach is justifiable, as the influence of the distribution on total emissions is negligible based on an estimate using Swiss data (OEP 2011b).

After the revision for Submission 2012 the distribution of the nitrogen flows is consistent with the allocation of volatile solids used for the calculation of CH₄ emissions (see Chapter 6.3.2.1.)

6.3.3 Uncertainties and Time-Series Consistency

For the uncertainty analysis the following input data from the Swiss Agroscope Reckenholz-Tänikon Research Station ART was used (ART 2008):

Table 6-12 Input data for the uncertainty analysis of the source category 4B "Manure Management". (ART 2008).

Input data for uncertainty analysis 4B	Lower bound (2.5 Percentile)	Upper bound (97.5 Percentile)	Mean uncertainty
Activity data CH ₄ (head)	-6.4%	+6.4%	±6.4%
Activity data N ₂ O (liquid systems and solid storage, kg N)	-29.9%	+29.2%	±29.5%
Emission factor CH ₄ (kg CH ₄ /head/yr)	-54.7%	+53.6%	±54.1%
Emission factor N ₂ O (liquid systems, kg N ₂ O-N / kg N)	-100%	+0%	±50%
Emission factor N ₂ O (solid storage, kg N ₂ O-N / kg N)	-75%	+50%	±62.5%

It is assumed that uncertainty estimations from Switzerland are also applicable for Liechtenstein. Liechtenstein applies the same methods and emission factors and has a sophisticated and livestock data collection system with low inaccuracies since 2002.

To apply for the Tier 1 uncertainty analysis, the arithmetic mean of lower and upper bound is used for activity data and for emission factors. For further results see Section 1.7.

For further results see Section 1.7. The time series 1990-2011 is consistent.

6.3.4 Source-Specific QA/QC and Verification

As mentioned in sections 1.6.1.4 and 1.6.1.5, the triple check of the CRF tables (detailed comparison of latest with previous data for the base year, for 2010 and for the changing rates 2010/2011) has been executed.

Documentation of the calculation method adapted from Switzerland ensures transparency and retraceability of the calculation methods and data sources (OEP 2011b, FOEN 2012). A quality control was done by Acontec and INFRAS by a countercheck of the calculation sheets.

The SE, the NIC and the NIR author report their QC activities in a checklist (see Annex 8).

6.3.5 Source-Specific Recalculations

4B: There is a difference in 2010 emissions of 0.21% or 0.007 Gg CO₂ eq. with regard to the figure for the same year in Submission 2012. This is due to updated data on milk production per head of mature dairy cattle, which had been estimated based on 2009 data for the 2012 submission (since the data for 2010 were not yet available at the time). Since energy consumption and thus excretion is estimated based on milk production, emissions from manure management were also affected (compare Chapter 6.2.5).

6.3.6 Source-Specific Planned Improvements

There are no further source-specific improvements planned.

6.4 Source Category 4C – Rice Cultivation

Rice Cultivation does not occur in Liechtenstein.

6.5 Source Category 4D – Agricultural Soils

6.5.1 Source Category Description

Key source 4D1, 4D3

Direct (4D1) N₂O emissions from agricultural soils are key sources by level.

Indirect (4D3) N₂O emissions from agricultural soils are key sources by level.

The source category 4D includes the following emissions: Direct N₂O emissions from soils, from animal production and indirect N₂O, NO_x and NMVOC emissions from agricultural soils.

In general, direct and indirect N₂O emissions have increased 2011 by 0.8% compared to 1990. The lowest N₂O emission level was 2000. Since then, total emissions are slightly increasing most probably because of newly increasing cattle numbers (see Figure 6-5).

Table 6-13 Specification of source category 4D “Agricultural Soils”. (AD: Activity data; EF: Emission factors).

4D	Source	Specification	Data Source
4D1	Direct soil emissions	Includes emissions from synthetic fertilizer, animal manure, crop residue, N-fixing crops, organic soils, residues from pasture range and paddock, N-fixing pasture range and paddock	AD: OA 2000, OA 2012, FAL/RAC 2001, Flisch et al. 2009, Agrammon 2010, , Leifeld et al. 2003, Schmid et al. 2000, Walther et al. 1994 EF: IPCC 1997c (N ₂ O); IPCC 2000
4D2	Pasture, range and paddock manure	Only emissions from pasture, range and paddock	AD: OA 2012, Flisch et al. 2009, Agrammon 2010 EF: IPCC 1997c
4D3	Indirect emissions	Leaching and run-off, N deposition air to soil	AD: OA 2012, Flisch et al. 2009; Agrammon 2010, Prasuhn and Braun 1994, Braun et al. 1994, Schmid et al. 2000 EF: IPCC 2000

6.5.2 Methodological Issues

6.5.2.1 Methodology

Liechtenstein applies the latest Swiss method of IULIA for calculating N₂O emissions from soils, because of the comparable agricultural situation in Liechtenstein with the same composition of soils and its agricultural management. Activity data is Liechtenstein specific. The methodology as well as differences between IULIA and the IPCC method are described in the following paragraph (*excerpt from NIR CH, chpt. 6.5.2, FOEN 2012*):

IULIA is an IPCC-derived method for the calculation of N₂O emissions from agriculture that basically uses the same emission factors, but adjusts the activity data to the particular situation of Switzerland (Schmid et al. 2000). According to Schmid et al. (2000) IULIA is better adapted to the conditions of Swiss agriculture, compared to the IPCC method. There is no indication that the adoption of the IPCC method would lead to a better estimation of the N₂O emissions in Switzerland.

IULIA has been updated in 2010 with new parameters derived from the Swiss ammonium model AGRAMMON (Agrammon 2010). New values for nitrogen excretion, manure system distribution and ammonium emission factors have been adopted

Main differences between the IULIA method and IPCC are (Schmid et al. 2000, p. 74):

- *IULIA estimates lower nitrogen excretion per animal category, especially due to the lower excretions of cattle*
- *The amount of losses to the atmosphere from the excreted nitrogen is more than 50% higher compared to IPCC.*
- *The amount of leaching (of nitrogen excreted and of synthetic fertilizers) is lower by 1/3 compared to IPCC.*
- *The share of solid storage out of the total manure is twofold; the share of excretion on pasture, range and paddock has been ½ in 1990 and has almost doubled thereafter reaching IPCC default values.*
- *The nitrogen inputs from biological fixation are higher by a factor of 30 since fixation on meadows and pastures are also considered. The consideration of nitrogen fixation from grassland is one of the major advantages of the method IULIA as the grassland accounts for the majority on nitrogen fixed in Swiss agricultural soils.*
- *The nitrogen inputs from crop residues are only 25% higher although emissions from plant residue on grasslands are considered. This is explained by the fact that the emissions from plant residues returned to soils on cropland are estimated 50% below the IPCC defaults.*

Despite the different assumptions of the two methods, differences at the level of the N₂O emissions are quite moderate. In total IULIA estimations of the N₂O emissions from agriculture are 15% lower than the IPCC estimations (Schmid et al. 2000, p. 75).

Direct emissions from soil (4D1)

Calculation of direct N₂O emissions from soil is based on IPCC 2000 Tier 1b. Liechtenstein follows the Swiss method IULIA using national activity data.

- Emissions from **synthetic fertilizer** include mineral fertilizer, compost and sewage sludge. From the amount of nitrogen in fertilizer, losses to the atmosphere in form of NH₃ are subtracted and the rest is multiplied by the corresponding emission factor. According to AGRAMMON losses to the atmosphere are 15% for urea and 2% for other synthetic fertilizers instead of the IPCC value of 10% for NH₃ and NO_x. (Agrammon 2010). The Fra_{C_{GAS}F} has declined considerably due to a reduction of the use of urea and sewage sludge which both have high NH₃ emission factors. NO_x emissions are not subtracted since they occur mainly after the fertilizer application. The basis for N₂O-emissions is the mineral fertilizer including the nitrogen that will be lost as NO_x later (Berthoud 2004).
- To model the emissions of **animal manure applied to soils**, nitrogen input from manure applied to soils is calculated. This is calculated by the total N excretion minus N excreted on pastures minus NH₃ volatilization from solid and liquid manure. NO_x emissions are not included in the amount subtracted as Fra_{C_{GAS}M}¹⁴ since they occur after the application of animal wastes and are therefore included in the indirect

¹⁴ Note that Fra_{C_{GAS}M} is calculated retrospectively from the nitrogen flow model. The amount of animal manure applied to soils in CRF table 4.Ds1 cannot be derived from the values given in CRF table 4.Ds2 and 4.B(b).

emissions from soil. Following AGRAMMON the losses (to the atmosphere) as ammonia are specified for each management category instead of using a fixed ratio of 20% (Agrammon 2010). For details regarding the volatilized N refer to Table 6-15.

- Emissions from **crop residues** are based on the amount of nitrogen in crop residues returned to soil. According to IULIA (Schmid et al. 2000, p. 68 and p. 100) the calculation of nitrogen in crop residues is based on data reported on crop yields in Liechtenstein, the standard values for arable crop yields for Switzerland and standard amounts of nitrogen in crop residues returned to soils for Switzerland (Flisch et al. 2009). The calculation of the amount of nitrogen in crop residues returned to soil according to IULIA is as follows (Schmid et al. 2000, p. 101):

$$F_{CR} = \sum_{Cr} (E_{Cr} * \frac{NR_{Cr}}{Y_{Cr}})$$

F_{CR} : Amount of nitrogen in crop residues returned to soils (t N)

E_{Cr} : Amount of crop yields for culture Cr (t)

Y_{Cr} : Standard values for arable crop yields for culture Cr (t/ha)

NR_{Cr} : Standard amount of nitrogen in crop residues returned to soils (t/ha)

From 2001 on updated standard values and amounts of nitrogen returned to soil are used. In addition to the N transfer from crop residues, IULIA also takes into account the plant residue returned to soils on meadows and pastures (Schmid et al. 2000). The grassland area in Liechtenstein is almost as large as the agricultural land. Input data on the managed area of meadows and pastures are taken from OA (2012).

- For calculation of emissions from **N-fixing crops**, IULIA assumes that 60% of the nitrogen in crops is caused by biological nitrogen fixation (Schmid et al. 2000, p. 70). This is in line with IPCC, assuming that biological nitrogen fixation supplies 50-60 per cent of the nitrogen in grain legumes (IPCC 1997c, p. 4.89). The total amount of nitrogen is calculated according to the calculation of nitrogen in crop residues. In addition, IULIA takes biological nitrogen fixation on meadows and pastures into account, assuming a nitrogen concentration of 3.5% in the dry matter from which 80% derives from biological nitrogen fixation. For the dry matter production of clover on pastures and meadows statistical data were used (Schmid et al. 2000, p. 70). The following table gives an overview of the calculation of emissions from N-fixing crops.

Table 6-14 Input values for calculation of emissions from N-fixing crops according to IULIA (Schmid et al. 2000, p. 70).

Fixation	Share of N caused by fixation	Share of N in Dry matter
Leguminous (N-fixing crops)	0.6	crop specific
Clover (Fixation meadows and pastures)	0.8	0.035

- Emissions from **cultivated organic soils** are based on estimations on the area of cultivated organic soils (OA 2012) and the IPCC default emission factor for N₂O emissions from cultivated organic soils (IPCC 1997b).

Emissions from animal production (pasture, range and paddock manure) (4D2)

The calculation of the N excretion per animal category corresponds to Chapter 6.3.2.2 on N₂O emissions. Calculation of these emissions are based on AGRAMMON (2010). IPCC equation 4.18, IPCC 2000: p. 4.42 is used, but specific N excretion rates and manure system distribution fractions (MS) are used. The relevant input data are based on Flisch et al. (2009) and calculated with the Swiss ammonium model AGRAMMON.

Only emissions of Pasture range and Paddock are to be reported under agricultural soils. Other emissions from animal production are reported under 4B Manure Management.

Indirect emissions (4D3)

Calculation of the indirect emissions is based on IPCC 2000 Tier 1b.

- For calculation of N₂O emissions from **leaching and run-off**, N from fertilizers and animal wastes has to be estimated. The data for the cultivated area is taken from Liechtenstein (OA 2012). Other relevant input data such as the information on leaching and run-off is taken from the Swiss statistics FAL/RAC (2001), Prasuhn and Braun (1994) and Braun et al. (1994). $Frac_{Leach}$ is set as 0.2 instead of the IPCC default of 0.3 (Prasuhn and Mohni 2003). This value is extrapolated from long-term monitoring and modelling studies from the Canton of Berne. According to Schmid et al. (2000, p. 71), the default value of IPCC leads to an overestimation of the emissions from leaching and run-off. The default value is based on a model which assumes that 30% of nitrogen from synthetic fertilizer and deposition is reaching water bodies. According to Schmid et al. (2000) this amount is not representative for N-excretion of livestock animals in Switzerland and therefore Liechtenstein.
- N₂O emissions from **deposition** are based on NH₃ and NO_x emissions:
NH₃ Losses to the atmosphere are calculated with the EF for 2002 from the Swiss emission model AGRAMMON (Agrammon 2010) as this is the year which is based on a farm survey (see Table 6-15 below). Activity data are Liechtenstein specific (OA 2012). Specific losses for all livestock categories are assumed. Ammonium volatilization of nitrogen in commercial fertilizers is 15% for urea, 2% for other synthetic fertilizers (Vanderweerden and Jarvis 1997) and between 5 and 18% for recycling fertilizers (sewage sludge and compost).
For NO_x emissions a constant emission factor of 0.7% of nitrogen excretion from livestock animals and commercial fertilizer-N is assumed (Schmid et al. 2000: p. 66, EEA 2007).

Thus $Frac_{GASF}$ is set constant to the level of Switzerland in 2002 according to FOEN (2012) due to lack of own data in Liechtenstein. Furthermore, 2.0 kg NH₃-N/ha agricultural soil is produced during decomposition of organic material.

Table 6-15 Overview of the ammonia emission factors. Data source is Agrammon (2010). The percentages indicate the shares of excreted N assumed to volatilize as NH₃ (FracGASM). NO_x is not included in FracGASM since NO_x emissions occur after the application of animal waste and are therefore included in the indirect emissions from soil.

Ammonia emission factor		
		%
Cattle		32.5
Mature dairy cattle		33.2
Mature non-dairy cattle		28.5
Young cattle		32.0
	Fattening Calves	38.2
	Pre-Weaned Calves	29.2
	Breeding Cattle 1st Year	31.8
	Breeding Cattle 2nd Year	27.9
	Breeding Cattle 3rd Year	29.4
	Fattening Cattle	41.2
Sheep		19.9
	Fattening Sheep	19.9
	Milk Sheep	21.8
Goats		24.5
	Goat places	24.5
Horses		22.0
	Horses < 3 years	18.4
	Horses > 3 years	22.3
Mules and Asses		22.7
Swine		45.9
	Piglets	38.5
	Fattening Pig over 25 kg	47.0
	Dry Sows	46.3
	Nursing Sows	39.0
	Boars	46.6
Poultry		32.0
	Growers	32.4
	Layers	32.1
	Broilers	27.5
	Turkey	29.6
	Other Poultry (Geese, Ducks, Ostriches, Quails)	28.0

6.5.2.2 Emission factors

The following IPCC default emission factors for calculating N₂O emissions from agricultural soils are used.

Table 6-16 Emission factors for calculating N₂O emissions from agricultural soils (IPCC 1997c, tables 4.18 (direct emissions), 4.22 (pasture, range and paddock) and 4.23 (indirect emissions); IPCC 2000: table 4.17 (organic soils).

Emission source	Emission factor
Direct emissions	
Synthetic fertilizer	0.0125 kg N ₂ O -N/kg N
Animal excreta nitrogen used as fertilizer	0.0125 kg N ₂ O -N/kg N
Crop residue	0.0125 kg N ₂ O -N/kg N
N-fixing crops	0.0125 kg N ₂ O -N/kg N
Organic soils	8 kg N ₂ O-N/ha/year
Residues pasture, range and paddock	0.0125 kg N ₂ O -N/kg N
N-fixing pasture, range and paddock	0.0125 kg N ₂ O -N/kg N
Indirect emissions	
Leaching and run-off	0.025 kg N ₂ O -N/kg N
Deposition	0.01 kg N ₂ O -N/kg N
Animal production	
Pasture, range and paddock	0.02 kg N ₂ O -N/kg N/a
Other (sewage sludge and compost used for fertilizing)	0.0125 kg N ₂ O -N/kg N

6.5.2.3 Activity data

Activity data for calculation of direct soil emissions originates from the following sources:

- As Liechtenstein has no data on the amount of mineral fertilizer used, data from Switzerland on the average N input per ha from SBV (2010) is used and extrapolated with the area fertilized in Liechtenstein from the Office of Agriculture (OA 2012) with the following formula:

$$\text{N input from mineral fertilizer CH [tN/a] / agricultural area CH [ha]} * (\text{agricultural area FL [ha]} - \text{area alps FL [ha]}) = \text{N-Input FL from mineral fertilizer [tN/a]}.$$

- Compost: Assumption that 15% of the total amount of compost in Liechtenstein goes into agriculture. N-content of compost stems from Agrar (2001).
- Nitrogen excretion: FAL/RAC (2001 p. 48/49), Schmid et al. (2000), Walther et al. (1994), Flisch et al. (2009), Agrammon (2010)

Relevant activity data for calculating N₂O emissions from soils is displayed in the following table.

Table 6-17 Activity data for calculating N₂O emissions from agricultural soils. For the sake of completeness, values for mineral (synthetic) fertilizer, sewage sludge and compost are displayed. For the calculation of the emissions only the total amount of synthetic fertilizer is used.

Related activity data		1990-1999									
		1990	1991	1992	1993	1994	1995	1996	1997	1998	1999
		Value									
Direct emissions											
Fertilizers (t N/yr)	Sum	223	237	233	222	209	207	191	171	172	177
	Mineral fertilizer (t N/yr)	201	204	205	191	181	184	174	153	157	164
	Sewage sludge (t N/yr)	22	32	27	30	28	23	16	18	15	12
	Compost (t N/yr)	0.3	0.2	0.3	0.3	0.3	0.3	0.4	0.3	0.3	0.4
Animal manure	Nitrogen input from manure applied to soils (t N/yr)	236	240	232	218	222	220	223	223	220	211
N-fixing crops	N fixation peas, dry beans, soybeans and leguminous vegetables (t N/yr)	143	147	150	153	159	165	162	163	164	165
Crop residue	N from crop residues (t N/yr)	191	198	199	200	202	205	198	197	196	195
Meadows and pasture	Area of meadows and pasture (ha)	4'181	4'202	4'224	4'245	4'267	4'288	4'298	4'307	4'317	4'326
Organic soils	Area of cultivated organic soils (ha)	159	159	159	159	159	159	159	159	159	159
Animal production											
Pasture, range and paddock	N excretion on pasture range and paddock (t N/yr)	102	101	99	93	92	92	96	95	94	91
Indirect emissions											
	N excretion of all animals (t N/yr)	493	498	482	454	460	457	462	462	454	436
	Fertilizer (t N/yr) (before losses)	240	257	251	240	227	223	204	183	184	188
Leaching and run-off	N from fertilizers and animal manure that is lost through leaching and run off (t N/yr)	147	151	147	139	137	136	133	129	128	125
Deposition	Emissions NH ₃ from fertilizers, animal manure and agricultural soils (tN/yr)	187	193	185	176	178	176	172	172	168	161
	Emissions NO _x from fertilizers and animal manure (t N/yr)	5	5	5	5	5	5	5	5	4	4
	Area of agricultural soils (ha)	5'278	5'298	5'318	5'337	5'357	5'377	5'397	5'417	5'436	5'456
	Sum volatilized N (NH ₃ and NO _x) from fertilizers, animal manure and agricultural soils (t N/yr)	192	199	190	181	183	181	176	176	172	165

Related activity data		2000-2009									
		2000	2001	2002	2003	2004	2005	2006	2007	2008	2009
		Value									
Direct emissions											
Fertilizers (t N/yr)	Sum	171	181	176	170	166	163	160	168	159	151
	Mineral fertilizer (t N/yr)	163	176	172	165	166	163	160	167	159	150
	Sewage sludge (t N/yr)	8	4	4	4	0	0	0	0	0	0
	Compost (t N/yr)	0.4	0.3	0.4	0.4	0.4	0.5	0.4	0.5	0.6	0.4
Animal manure	Nitrogen input from manure applied to soils (t N/yr)	206	217	223	224	223	230	239	243	245	244
N-fixing crops	N fixation peas, dry beans, soybeans and leguminous vegetables (t N/yr)	167	169	171	177	181	181	179	183	178	175
Crop residue	N from crop residues (t N/yr)	194	195	196	200	202	198	198	199	198	196
Meadows and pasture	Area of meadows and pasture (ha)	4'336	4'368	4'400	4'543	4'670	4'570	4'546	4'568	4'523	4'492
Organic soils	Area of cultivated organic soils (ha)	159	159	159	159	159	159	159	159	159	159
Animal production											
Pasture, range and paddock	N excretion on pasture range and paddock (t N/yr)	83	93	93	95	99	103	109	110	111	110
Indirect emissions											
	N excretion of all animals (t N/yr)	424	449	462	465	467	483	503	511	515	513
	Fertilizer (t N/yr) (before losses)	181	190	185	178	173	170	167	175	166	157
Leaching and run-off	N from fertilizers and animal manure that is lost through leaching and run off (t N/yr)	121	128	129	129	128	131	134	137	136	134
Deposition	Emissions NH ₃ from fertilizers, animal manure and agricultural soils (tN/yr)	159	163	170	171	167	173	178	182	182	181
	Emissions NO _x from fertilizers and animal manure (t N/yr)	4	4	5	5	4	5	5	5	5	5
	Area of agricultural soils (ha)	5'476	5'476	5'476	5'476	5'476	5'476	5'476	5'476	5'476	5'476
	Sum volatilized N (NH ₃ and NO _x) from fertilizers, animal manure and agricultural soils (t N/yr)	163	167	174	175	172	177	183	186	187	186

Related activity data		2010-2011	
		2010	2011
		Value	
Direct emissions			
Fertilizers (t N/yr)	Sum	175	175
	Mineral fertilizer (t N/yr)	174	174
	Sewage sludge (t N/yr)	0	0
	Compost (t N/yr)	0.4	0.4
Animal manure	Nitrogen input from manure applied to soils (t N/yr)	236	241
N-fixing crops	N fixation peas, dry beans, soybeans and leguminous vegetables (t N/yr)	168	189
Crop residue	N from crop residues (t N/yr)	190	206
Meadows and pasture	Area of meadows and pasture (ha)	4'341	5'000
Organic soils	Area of cultivated organic soils (ha)	159	159
Animal production		0	0
Pasture, range and paddock	N excretion on pasture range and paddock (t N/yr)	109	113
Indirect emissions		0	0
	N excretion of all animals (t N/yr)	498	510
	Fertilizer (t N/yr) (before losses)	182	182
Leaching and run-off	N from fertilizers and animal manure that is lost through leaching and run off (t N/yr)	136	138
Deposition	Emissions NH ₃ from fertilizers, animal manure and agricultural soils (tN/yr)	177	180
	Emissions NO _x from fertilizers and animal manure (t N/yr)	5	5
	Area of agricultural soils (ha)	5'476	5'476
	Sum volatilized N (NH ₃ and NO _x) from fertilizers, animal manure and agricultural soils (t N/yr)	181	185

6.5.3 Uncertainties and Time-Series Consistency

For the uncertainty analysis the following input data from the Swiss Agroscope Reckenholz-Tänikon Research Station ART was used (ART 2008):

Table 6-18 Input data for the uncertainty analysis of the source category 4D "Agricultural Soils". (ART 2008).

Input data for uncertainty analysis 4D	Lower bound (2.5 Percentile)	Upper bound (97.5 Percentile)	mean uncertainty
Activity data 4D1 (fertilizer, kg N)	-12.4%	+10.3%	±11.3%
Activity data 4D1 (organic soils, hectares)	-29.4%	+29.4%	±29.4%
Activity data 4D2 (kg N)	-54.2%	+60.5%	±57.3%
Activity data 4D3 (deposition, kg N)	-34.6%	+48.3%	±41.4%
Activity data 4D3 (leaching and run-off, kg N)	-22.2%	+22.0%	±22.1%
Emission factor 4D1 (fertilizer, kg N ₂ O-N / kg N)	-80%	+80%	±80%
Emission factor 4D1 (organic soils, kg N ₂ O-N / kg N)	-75%	+87.5%	±81.3%
Emission factor 4D2 (kg N ₂ O-N / kg N)	-75%	+50%	±62.5%
Emission factor 4D3 (deposition, kg N ₂ O-N / kg N)	-80%	+100%	±90%
Emission factor 4D3 (leaching and run-off, kg N ₂ O-N / kg N)	-92%	+380%	±236%

It is assumed that uncertainty estimations from Switzerland are also applicable for Liechtenstein, since Liechtenstein applies the same methodology and emission factors. Also for activity data country specific uncertainty estimations are not available. Therefore, Swiss estimations are used as a first guess.

To apply for the Tier 1 uncertainty analysis, the arithmetic mean of lower and upper bound is used for activity data uncertainty and for emission factor uncertainty. For further results see Section 1.7.

Time series between 1990 and 2011 is consistent.

6.5.4 Source-Specific QA/QC and Verification

As mentioned in sections 1.6.1.4 and 1.6.1.5, the triple check of the CRF tables (detailed comparison of latest with previous data for the base year, for 2010 and for the changing rates 2010/2011) has been executed.

Documentation of the calculation method adapted from Switzerland ensures transparency and retraceability of the calculation methods and data sources (OEP 2011b, FOEN 2012). A quality control was done by Acontec and INFRAS by a countercheck of the calculation sheets.

The SE, the NIC and the NIR author report their QC activities in a checklist (see Annex 8).

6.5.5 Source-Specific Recalculations

4D: There is a difference in 2010 emissions of +1.61% or 0.14 Gg CO₂ eq. with regard to the value for the same year in Submission 2011. This is due to updated land use data that was not available for Submission 2011.

6.5.6 Source-Specific Planned Improvements

No further source-specific Improvements are planned.

6.6 Source Category 4E – Burning of savannas

Burning of savannas does not occur (NO) as this is not an agricultural practice in Liechtenstein.

6.7 Source Category 4F – Field Burning of Agricultural Residues

Field burning of agricultural residues is not occurring in Liechtenstein.

7 Land Use, Land-Use Change and Forestry

7.1 Overview

This chapter includes information about the estimation of greenhouse gas emissions and removals from land use, land-use change and forestry (LULUCF). The data acquisition and calculations are based on the Good Practice Guidance for Land Use, Land-Use Change and Forestry (IPCC 2003). They are completed by country specific methodologies from Switzerland, which were almost fully adopted to Liechtenstein.

The land areas from 1990 to 2003 are represented by geographically explicit land-use data with a resolution of one hectare (following a Tier 3 approach; IPCC 2003). Direct and repeated assessment of land use with full spatial coverage also enables to calculate spatially explicit land-use change matrices. Land-use statistics for Liechtenstein are available for the years 1984, 1996, 2002 and 2008. They are based on the same methodology as the Swiss land-use statistics (SFSO 2006a). Since the submission of 2011 the new 2009 dataset, based on the 2008 Land-use statistics is used.

In Liechtenstein, country specific emission factors and carbon stock values for forests and partially for agricultural land and grassland were applied. For other land use categories, IPCC default values or expert estimates from Switzerland are used.

The six main land categories required by IPCC (2003) are: A. Forest Land, B. Cropland, C. Grassland, D. Wetlands, E. Settlements and F. Other Land. These categories were further divided in 18 sub-divisions of land use (Table 7-3). A further spatial stratification reflects the criteria 'altitude' (3 zones) and 'soil type' (mineral, organic).

Table 7-2 shows the net CO₂ removals of the LULUCF sector. Figure 7-1 and Table 7-1 summarize the CO₂ equivalent emissions and removals in consequence of carbon losses and gains for the years 1990-2011. The total net removals/emissions of CO₂ equivalent vary between -3.42 Gg (2002) and -8.43 Gg (1996) from 1990 to 2011. Three components of the CO₂ balance are shown separately:

- Increase of living biomass on forest land: this is the growth of biomass on forest land remaining forest land; it is the largest sink of carbon.
- Decrease of living biomass on forest land: this is the decrease of carbon in living biomass (by harvest and mortality) on forest land remaining forest land; it is the largest source of carbon.
- Land-use change and soil: this is all the rest including carbon removals/emissions due to land-use changes and use of soils, especially of organic soils.

In all the years, growth of biomass exceeds the harvesting and mortality rate. Compared to these biomass changes in forests, the net CO₂ equivalent emissions arising from all land-use changes and from the soils are relatively small (see Figure 7-1).

Table 7-1 Liechtenstein's CO₂ equivalent emissions/removals [Gg] of the source category 5 LULUCF 1990-2011. Positive values refer to emissions; negative values refer to removals from the atmosphere.

LULUCF	1990	1991	1992	1993	1994	1995	1996	1997	1998	1999
	Gg CO ₂									
Increase of living biomass in forest	-68.7	-68.8	-68.9	-69.0	-69.1	-69.2	-69.2	-69.3	-69.4	-69.5
Decrease of living biomass in forest	49.0	49.0	49.1	49.2	49.2	49.3	49.3	49.4	49.5	49.6
Land-use change and soil	10.3	10.3	10.3	10.2	10.2	10.2	10.2	10.5	10.8	11.0
Sector 5 LULUCF (total)	-9.47	-9.51	-9.54	-9.58	-9.61	-9.65	-9.68	-9.41	-9.14	-8.87

LULUCF	2000	2001	2002	2003	2004	2005	2006	2007	2008	2009
	Gg CO ₂									
Increase of living biomass in forest	-69.6	-69.7	-69.7	-69.8	-69.9	-70.0	-70.1	-70.2	-70.3	-70.4
Decrease of living biomass in forest	49.7	49.7	49.8	49.9	50.1	50.2	50.3	50.4	50.5	50.6
Land-use change and soil	11.3	11.6	11.9	11.9	12.0	12.1	12.2	12.3	12.4	12.5
Sector 5 LULUCF (total)	-8.60	-8.33	-8.06	-7.95	-7.84	-7.72	-7.61	-7.50	-7.39	-7.26

LULUCF	2010	2011	Mean
Increase of living biomass in forest	-70.5	-70.6	-69.6
Decrease of living biomass in forest	50.8	50.9	49.8
Land-use change and soil	12.6	12.7	11.3
Sector 5 LULUCF (total)	-7.16	-7.04	-8.57

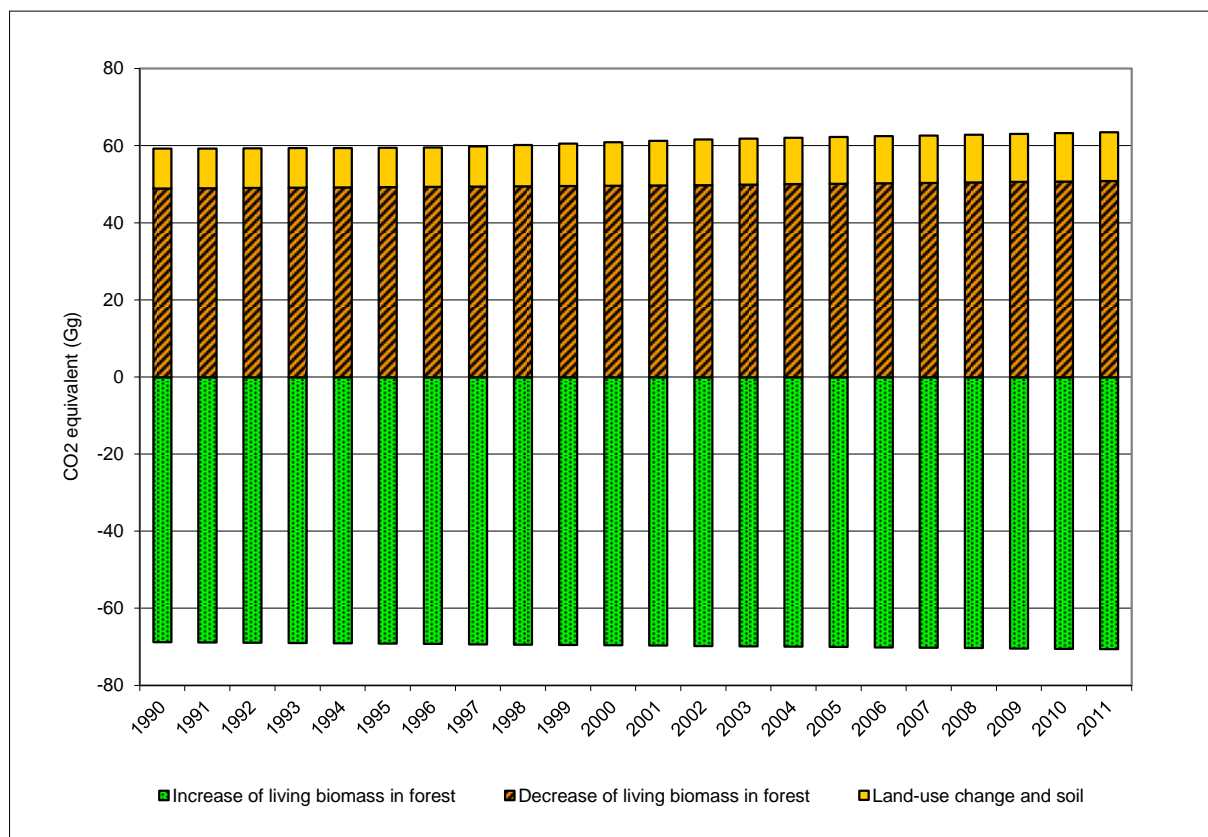
Figure 7-1 The CO₂ removals due to the increase (growth) of living biomass on forest land, the CO₂ emissions due to the decrease (harvest and mortality) of living biomass on forest land and the net CO₂ equivalent emissions due to land-use changes and from use of soils, 1990–2011.

Increase and decrease of living biomass in forests are the dominant categories when looking at the CO₂ emissions and removals (refer to Table 7-1 and Figure 7-1). Emissions and removals from forest land are quite stable over time. The dominant category when looking at the changes in net CO₂ removals are grassland and settlements (refer to Table 7-2). It can be observed that land-use conversions to grassland differ significantly between the three time periods 1990 to 1996, 1997 to 2002 and 2003 to 2011. In the period 1997 to 2002 a significant higher conversion from forest land to grassland leads to a reduction of net CO₂ removals. However, the application of a conversion period of 20 years smooths and delays the effect in time.

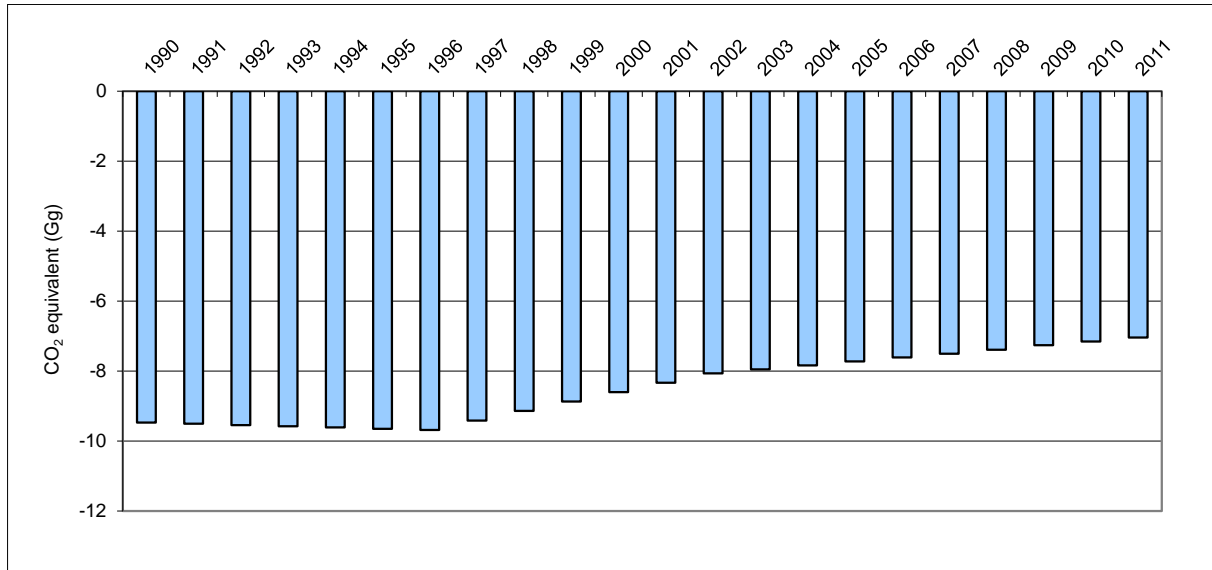

Figure 7-2 Liechtenstein's CO₂ emissions/removals of source category 5 LULUCF 1990–2011 in Gg CO₂ equivalent. Negative values refer to removals.

Table 7-2 Net CO₂ removals and emissions per land-use category in Gg CO₂ eq., 1990-2011.

Net CO ₂ emissions/removals	1990	1991	1992	1993	1994	1995	1996	1997	1998	1999
Total Land-Use Categories	-9.47	-9.51	-9.54	-9.58	-9.61	-9.65	-9.68	-9.41	-9.14	-8.87
A. Forest Land	-19.99	-20.01	-20.03	-20.04	-20.06	-20.08	-20.10	-20.11	-20.13	-20.15
1. Forest Land remaining Forest Land	-17.89	-17.91	-17.93	-17.95	-17.97	-17.98	-18.00	-18.04	-18.08	-18.12
2. Land converted to Forest Land	-2.10	-2.10	-2.10	-2.10	-2.10	-2.10	-2.10	-2.07	-2.05	-2.03
B. Cropland	4.44	4.43	4.43	4.42	4.42	4.41	4.41	4.44	4.47	4.50
1. Cropland remaining Cropland	4.10	4.09	4.08	4.08	4.07	4.07	4.06	4.09	4.12	4.15
2. Land converted to Cropland	0.34	0.34	0.34	0.34	0.34	0.34	0.34	0.35	0.35	0.35
C. Grassland	1.91	1.89	1.88	1.87	1.86	1.85	1.84	1.97	2.11	2.24
1. Grassland remaining Grassland	1.60	1.59	1.58	1.57	1.56	1.55	1.53	1.50	1.47	1.44
2. Land converted to Grassland	0.30	0.30	0.30	0.30	0.30	0.30	0.30	0.47	0.64	0.80
D. Wetlands	0.16	0.16	0.16	0.16	0.16	0.16	0.16	0.17	0.18	0.19
1. Wetlands remaining Wetlands	NO	NO	NO	NO	NO	NO	NO	NO	NO	NO
2. Land converted to Wetlands	0.16	0.16	0.16	0.16	0.16	0.16	0.16	0.17	0.18	0.19
E. Settlements	3.58	3.58	3.58	3.58	3.58	3.58	3.58	3.62	3.65	3.69
1. Settlements remaining Settlements	0.28	0.28	0.28	0.28	0.28	0.28	0.28	0.29	0.29	0.29
2. Land converted to Settlements	3.30	3.30	3.30	3.30	3.30	3.30	3.30	3.33	3.36	3.40
F. Other Land	0.44	0.44	0.44	0.44	0.44	0.44	0.44	0.51	0.59	0.66
1. Other Land remaining Other Land	0.00	0.00	0.00	0.00	0.00	0.00	0.00	0.00	0.00	0.00
2. Land converted to Other Land	0.44	0.44	0.44	0.44	0.44	0.44	0.44	0.51	0.59	0.66

Net CO ₂ - emissions/removals	2000	2001	2002	2003	2004	2005	2006	2007	2008	2009
Total Land-Use Categories	-8.60	-8.33	-8.06	-7.95	-7.84	-7.72	-7.61	-7.50	-7.39	-7.26
A. Forest Land	-20.17	-20.18	-20.20	-20.17	-20.14	-20.11	-20.08	-20.05	-20.02	-20.00
1. Forest Land remaining Forest Land	-18.16	-18.20	-18.24	-18.25	-18.25	-18.26	-18.27	-18.27	-18.28	-18.30
2. Land converted to Forest Land	-2.01	-1.98	-1.96	-1.92	-1.89	-1.85	-1.81	-1.77	-1.74	-1.70
B. Cropland	4.53	4.56	4.59	4.59	4.59	4.59	4.59	4.59	4.59	4.59
1. Cropland remaining Cropland	4.18	4.21	4.24	4.25	4.27	4.28	4.30	4.31	4.33	4.34
2. Land converted to Cropland	0.35	0.35	0.35	0.33	0.32	0.30	0.29	0.27	0.26	0.24
C. Grassland	2.38	2.51	2.65	2.71	2.76	2.82	2.88	2.94	3.00	3.06
1. Grassland remaining Grassland	1.41	1.38	1.34	1.32	1.29	1.27	1.24	1.22	1.19	1.17
2. Land converted to Grassland	0.97	1.14	1.30	1.39	1.47	1.55	1.64	1.72	1.80	1.89
D. Wetlands	0.20	0.21	0.22	0.22	0.22	0.22	0.22	0.22	0.22	0.22
1. Wetlands remaining Wetlands	NO	NO	NO	NO	NO	NO	NO	NO	NO	NO
2. Land converted to Wetlands	0.20	0.21	0.22	0.22	0.22	0.22	0.22	0.22	0.22	0.22
E. Settlements	3.72	3.76	3.80	3.79	3.79	3.79	3.78	3.78	3.78	3.79
1. Settlements remaining Settlements	0.30	0.30	0.30	0.30	0.30	0.30	0.30	0.30	0.30	0.30
2. Land converted to Settlements	3.43	3.46	3.49	3.49	3.49	3.49	3.48	3.48	3.48	3.50
F. Other Land	0.74	0.82	0.89	0.92	0.94	0.97	0.99	1.02	1.05	1.08
1. Other Land remaining Other Land	0.00	0.00	0.00	0.00	0.00	0.00	0.00	0.00	0.00	0.00
2. Land converted to Other Land	0.74	0.82	0.89	0.92	0.94	0.97	0.99	1.02	1.05	1.08

Net CO ₂ - emissions/removals	2010	2011
Total Land-Use Categories	-7.16	-7.04
A. Forest Land	-19.98	-19.96
1. Forest Land remaining Forest Land	-18.32	-18.34
2. Land converted to Forest Land	-1.66	-1.62
B. Cropland	4.59	4.59
1. Cropland remaining Cropland	4.36	4.37
2. Land converted to Cropland	0.23	0.22
C. Grassland	3.12	3.18
1. Grassland remaining Grassland	1.15	1.13
2. Land converted to Grassland	1.97	2.05
D. Wetlands	0.22	0.22
1. Wetlands remaining Wetlands	NO	NO
2. Land converted to Wetlands	0.22	0.22
E. Settlements	3.77	3.77
1. Settlements remaining Settlements	0.30	0.29
2. Land converted to Settlements	3.48	3.48
F. Other Land	1.12	1.15
1. Other Land remaining Other Land	0.00	0.00
2. Land converted to Other Land	1.12	1.15

The next chapter (7.2) gives an overview of the methodical approach including the calculation of the activity data (land-use data) and carbon emissions. The subsequent chapters (7.3- 7.8) describe the details of the CO₂ equivalent removal/emission calculations for each main land-use category.

Non CO₂-emissions are very small or even zero (Total LULUCF 0.000048 Gg N₂O in 2011). They arise from soil disturbances associated with land-conversion to cropland (CRF Table 5 III). The calculation method is based on IPCC default procedures (IPCC 2003, chapter 3) and summarized in chapter 7.4.2.

7.2 Methodical Approach and Activity Data

7.2.1 General Approach for Calculating Carbon Emissions/Removals

The selected procedure for calculating carbon emissions and removals in the LULUCF sector is done as for Switzerland (FOEN 2006a). It corresponds to a Tier 2 approach as described in IPCC (2003; chapter 3) and can be summarised as follows:

- Land use categories and sub-divisions with respect to available land-use data (see Table 7-3) were defined. For these carbon emissions and removals estimations so-called combination categories (CC) were defined on the basis of the land-use and land-cover categories of the Swiss land-use statistics (FOEN 2006; SFSO 2006a).
- Criteria for the spatial stratification of the land-use categories (altitude and soil type) were taken from Switzerland. Based on these criteria data for the spatial stratification of the land-use categories were collected in Liechtenstein.
- For carbon stocks and carbon stock changes for each spatial stratum of the land-use categories Swiss data based on measurements and estimations were taken.
- The land use and the land-use change matrix were calculated in each spatial stratum.
- Carbon stock changes in living biomass (ΔC_l), in dead organic matter (ΔC_d) and in soil (ΔC_s) were calculated for all cells of the land-use change matrix.
- Finally, the results were aggregated by summarising the carbon stock changes over land-use categories and strata according to the level of disaggregation displayed in the CRF tables.

The procedure of calculating emissions and removals in LULUCF and the different institutions involved are displayed in Figure 7-3.

The distinction between managed and unmanaged land (Table 7-3) is done as follows:

- Forest land is by definition managed land as all forests in Liechtenstein are subject to forest management.
- Land categories where nothing can be cultivated on it, are classified as unmanaged. This holds for stony grassland, unproductive grassland, surface waters and unproductive wetland and other land (rocks, sand, glaciers).

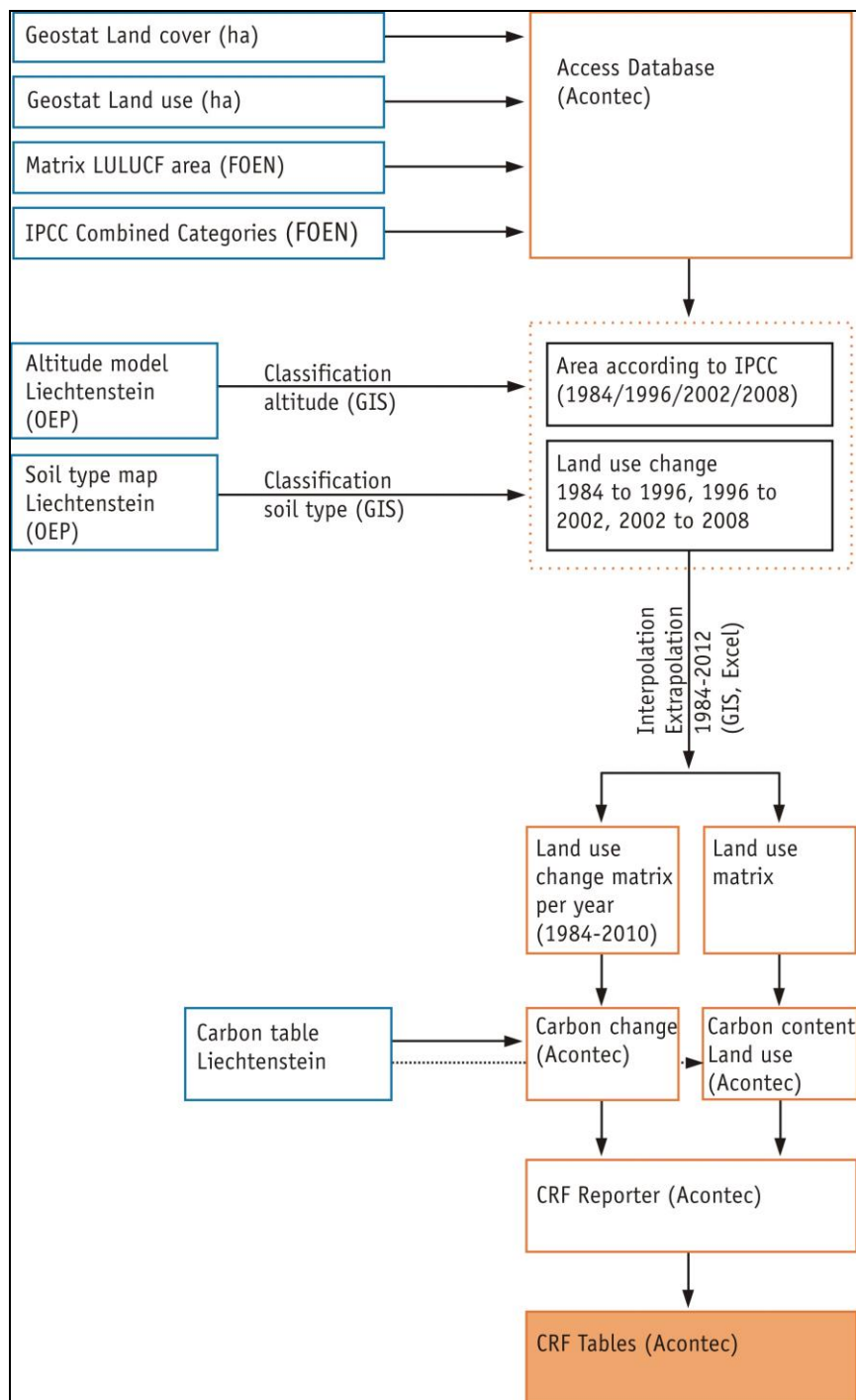

Figure 7-3 Procedure of calculating emissions and removals from LULUCF in Liechtenstein.

Table 7-3 Land-use categories used in this report (so-called combination categories CC): 6 main land-use categories and the 18 sub-divisions. Additionally, descriptive remarks, abbreviations used in the CRF tables, and CC codes are given. For a detailed definition of the CC categories see FOEN (2006) and SFSO (2006a).

CC Main category	CC Sub-division	Remarks	Managed or unmanaged	CC code
A. Forest Land	Afforestations	areas converted to forest by active measures, e.g. planting ¹⁵	managed	11
	Managed Forest	dense and open forest meeting the criteria of forest land	managed	12
	Unproductive Forest	brush forest and inaccessible forest meeting the criteria of forest land	managed	13
B. Cropland		arable and tillage land (annual crops and leys in arable rotations)	managed	21
C. Grassland	Permanent Grassland	meadows, pastures (low-land and alpine)	managed	31
	Shrub Vegetation	agricultural and unproductive areas predominantly covered by shrubs	managed	32
	Vineyards, Low-Stem Orchards, Tree Nurseries	perennial agricultural plants with woody biomass (no trees)	managed	33
	Copse	agricultural and unproductive areas covered by perennial woody biomass including trees	managed	34
	Orchards	permanent grassland with fruit trees	managed	35
	Stony Grassland	grass, herbs and shrubs on stony surfaces	unmanaged	36
	Unproductive Grassland	unmanaged grass vegetation	unmanaged	37
D. Wetlands	Surface Waters	lakes and rivers	unmanaged	41
	Unproductive Wetland	reed, unmanaged wetland	unmanaged	42
E. Settlements	Buildings and Constructions	areas without vegetation such as houses, roads, construction sites, dumps	managed	51
	Herbaceous Biomass in Settlements	areas with low vegetation, e.g. lawns	managed	52
	Shrubs in Settlements	areas with perennial woody biomass (no trees)	managed	53
	Trees in Settlements	areas with perennial woody biomass including trees	managed	54
F. Other Land		areas without soil and vegetation: rocks, sand, screes, glaciers	unmanaged	61

¹⁵ Reforestation does not occur in Liechtenstein. For more than 100 years, the area of forest has not decreased anymore. Any reforestation would have required a deforestation within the last 50 years, but deforestation is prohibited by law (OEP 2007b).

The following paragraph gives some further explanations about the Swiss calculation of carbon stock changes:

Swiss methodology (excerpt from NIR CH, chpt. 7.2.1, FOEN 2007):

For calculating carbon stock changes, the following input parameters (mean values per hectare) must be quantified for all land-use categories (CC) and spatial strata (i):

$stockC_{l,i,CC}$:	carbon stock in living biomass
$stockC_{d,i,CC}$:	carbon stock in dead organic matter
$stockC_{s,i,CC}$:	carbon stock in soil
$increaseC_{l,i,CC}$:	annual increase (growth) of carbon in living biomass
$decreaseC_{l,i,CC}$:	annual decrease (harvesting) of carbon in living biomass
$changeC_{d,i,CC}$:	annual net carbon stock change in dead organic matter
$changeC_{s,i,CC}$:	annual net carbon stock change in soil

On this basis, the carbon stock changes in living biomass (ΔC_l), in dead organic matter (ΔC_d) and in soil (ΔC_s) are calculated for all cells of the land-use change matrix. Each cell is characterized by a land-use category before the conversion (b), a land-use category after the conversion (a) and the area of converted land within the spatial stratum (i). Equations 7.2.1.-7.2.3 show the general approach of calculating C-removals/emissions taking into account the net carbon stock changes in living biomass, dead organic matter and soils as well as the stock changes due to conversion of land use (difference of the stocks before and after the conversion):

$$\Delta C_{l,i,ba} = [increaseC_{l,i,a} - decreaseC_{l,i,a} + W_l * (stockC_{l,i,a} - stockC_{l,i,b})] * A_{i,ba} \quad (7.2.1)$$

$$\Delta C_{d,i,ba} = [changeC_{d,i,a} + W_d * (stockC_{d,i,a} - stockC_{d,i,b})] * A_{i,ba} \quad (7.2.2)$$

$$\Delta C_{s,i,ba} = [changeC_{s,i,a} + W_s * (stockC_{s,i,a} - stockC_{s,i,b})] * A_{i,ba} \quad (7.2.3)$$

where:

- a: land-use category after conversion (CC = a)
- b: land-use category before conversion (CC = b)
- ba: land use conversion from b to a
- $A_{i,ba}$: area of land converted from b to a in the spatial stratum i (activity data from the land-use change matrix)
- W_l, W_d, W_s : weighting factors for living biomass, dead organic matter and soil, respectively.

The following values for W were chosen:

$$W_l = W_d = W_s = 0 \quad \text{if land use after the conversion is 'Forest Land' (a = \{11, 12, 13\})} \\ \text{or if a and b are unmanaged categories \{36, 37, 41, 42, 61\}}$$

$$W_s = 0.5 \quad \text{if a or b is 'Buildings and Constructions' (a = 51 or b = 51)}$$

$$W_l = W_d = W_s = 1 \quad \text{otherwise.}$$

The difference of the stocks before and after the conversion are weighted with a factor (W_l, W_d, W_s) accounting for the effectiveness of the land-use change in some special cases. For example, the succession from grassland to forest land is quite frequent in mountainous regions [in Switzerland]. Immediately after the conversion young forests have lower carbon stocks than the mean carbon stock values determined for 'managed forest'. Therefore, the weighting factors for the conversion 'to forest land' was set to zero in order to avoid an overestimation of C-sinks. In the case of land-use changes involving 'buildings and constructions' it is assumed that only 50% of the soil carbon is emitted as the humus layer is re-used on construction sites.

For all land-use categories applies: If a equals b, there is no change in land use and the difference in carbon stocks becomes zero.

In the CRF tables 5.A to 5.F, land-use categories (CC) and associated spatial strata are partially shown at an aggregated level for optimal documentation and overview. The values of ΔC are accordingly summarised. Positive values of $\Delta C_{i,ba}$ are inserted in the column "Increase" and negative values in column "Decrease", respectively (besides $\Delta C_{i,CC}$ and $\Delta C_{i,CC}$ if land-use does not change).

The weighting factors W equal zero in case of changes between unmanaged categories corresponds a recommendation of the Expert Review Team. After kept as a planned improvement, it is now implemented in the LULUCF modelling scheme.

For calculating annual carbon stock changes in soils due to land-use conversion, IPCC (2003) suggests a default delay time (inventory period) of 20 years. In Liechtenstein, a conversion time of 20 years has been applied to all carbon stock changes in soil and biomass. Accordingly, the CRF tables 5A2, 5B2 and 5C2, 5D2, 5E2 and 5F2 contain the cumulative area remaining in the respective category in the reporting year.

There is no consistent data on land-use changes before 1984, but it is known (Broggi 1987, ARE/SAEFL 2001 in Switzerland) that the main trends of the land-use dynamics (e.g. increase of settlements, decrease of cropland) did arise before 1970. Therefore, it was assumed that between 1971 and 1989 the annual rate of all land-use changes was the same as in 1990. Based on this assumption it has been possible to produce the land-use data required for the consideration of the conversion time in that period.

7.2.2 General Approach for Compiling Land-use Data

7.2.2.1 Land-Use Statistics (AREA)

Land-use data from Liechtenstein are collected according to the same method as in Switzerland. Every hectare of the territory was assigned to one of 46 land-use categories and to one of 27 land-cover categories by means of stereographic interpretation of aerial photos (EDI/BFS 2009).

For the reconstruction of the land use conditions in Liechtenstein for the period 1990-2012 four data sets are used:

- Land-Use Statistics 1984
- Land-Use Statistics 1996
- Land-Use Statistics 2002
- Land-Use Statistics 2008

Land-use statistics from the years 1984 and 1996 were originally evaluated according to a set of different land-use categories. For this purposes they were being re-evaluated according to the newly designed land-use and land-cover categories (SFSO 2006a). For the interpretation of the 2002 and 2008 data the new land-use and land-cover categories were used directly (EDI/BFS 2009).

7.2.2.2 Combination Categories (CC) as derived from Land-Use Statistics

The 46 land-use categories and 27 land-cover categories of the land-use statistics were aggregated to 18 combination categories (CC, FOEN 2006b) implementing the main categories proposed by IPCC as well as by Swiss country specific sub-divisions (see Table 7-3). The sub-divisions were defined with respect to optimal distinction of biomass densities, carbon turnover, and soil carbon contents.

The first digit of the CC-code represents the main category, whereas the second digit stands for the respective sub-division.

7.2.2.3 Interpolation and extrapolation of the status for each year

The exact dates of aerial photo shootings are known for each hectare (in Liechtenstein data available for the years 1984, 1996, 2002 and 2008). However, the exact year of the land-use change on a specific hectare is unknown. The actual change can have taken place in any year between the two land-use surveys. It is assumed that the probability of a land-use change from 1984 and 1996, 1996 to 2002 and from 2002 to the 2008 survey is uniformly distributed over the respective interim period between two surveys. Therefore, the land-use change of each hectare has to be equally distributed over its specific interim period (e.g. when a specific area increased by three hectares between 1996 and 2002, it was assumed that the annual increase was 0.5 hectares).

Thus, the land-use status for the years between two data collection dates can be calculated by linear interpolation. Dates of aerial photo and the land-use categories of 1984 and 1996 for every hectare are used for these calculations. The status after 2008 is estimated by linear extrapolation, assuming that the average trend observed between 1984 and 2008 goes on.

Example (Figure 7-4): A certain area has been assigned to the land-use category “Cropland” (CC 21) in 1984. A partial land-use change to “Shrubs in Settlements” (CC 53) has been discovered in 1996. And another partial change to “Buildings and construction” (CC 51) was discovered in 2002.

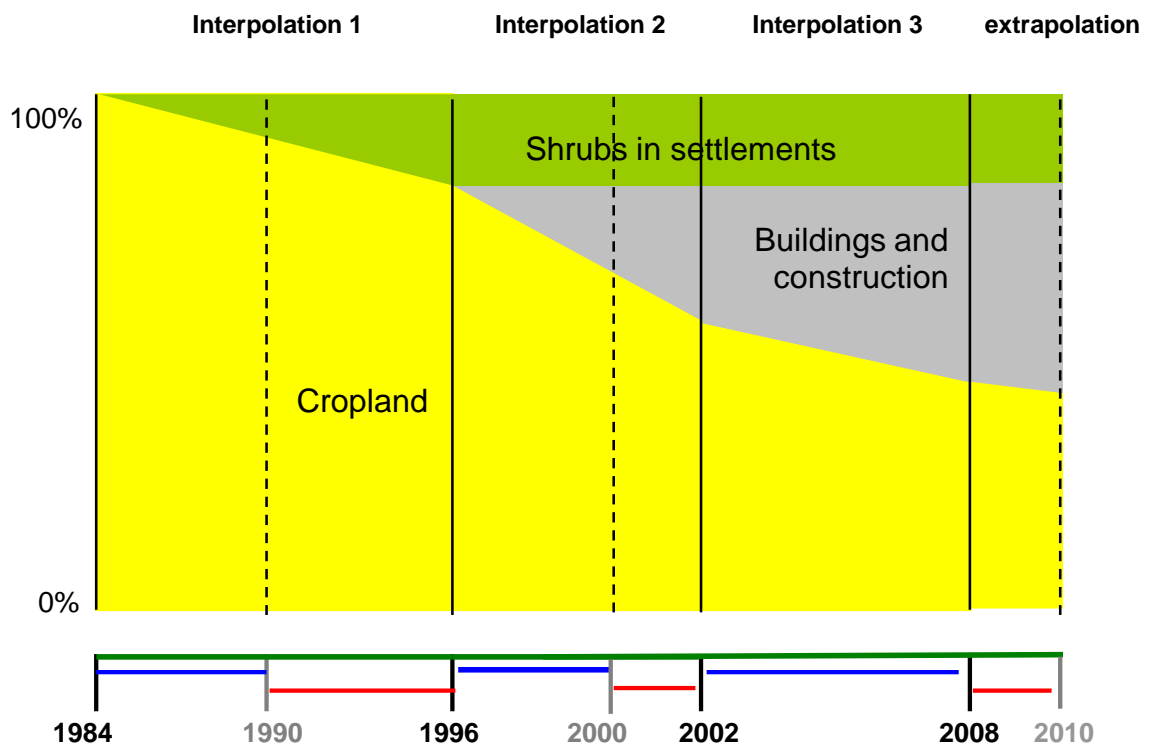

Figure 7-4 Hypothetical linear development of land-use changes between the four different Land Use Statistics (1984, 1996, 2002, 2008) with the example of a hectare changing from “cropland” to “shrubs in settlements” and then twice from “shrubs in settlements” to “buildings and constructions”. The dotted lines show how the share of the different Land Use Categories is determined in years between Land Use Statistics.

The ‘status 1990’ is determined by calculating the fractions of the two land-use categories for the year 1990. A linear development from “cropland” to “shrubs in settlements” during the whole interim period is assumed. The same procedure can be applied for two survey dates between 1996 and 2002 (see year 2002 Figure 7-4 as example). Extrapolation after 2008 is done by taking the average trend of the whole time period 1984 to 2008. The ‘status’ for each

individual year in the period 1990-2008 for the whole territory of Liechtenstein results from the summation of the fractions of all hectares per combination category CC (considering the spatial strata where appropriate; see Table 7-6).

7.2.3 Spatial Stratification

In order to quantify carbon stocks and increases/decreases, a further spatial stratification of the territory turned out to be useful. For forests and grassland three different altitudinal belts were differentiated. The whole territory of Liechtenstein is considered to be part of the pre-alpine region (Thürig et al. 2004).

Altitude data were available on a hectare-grid from the Office of Environmental Protection (OEP 2006d) and classified in belts ≤ 600 m a.s.l. (metres above sea level), 601-1200 m a.s.l., and >1200 m a.s.l. (Figure 7-5).

For cropland and grassland, two soil types (organic and mineral soils) were additionally differentiated.

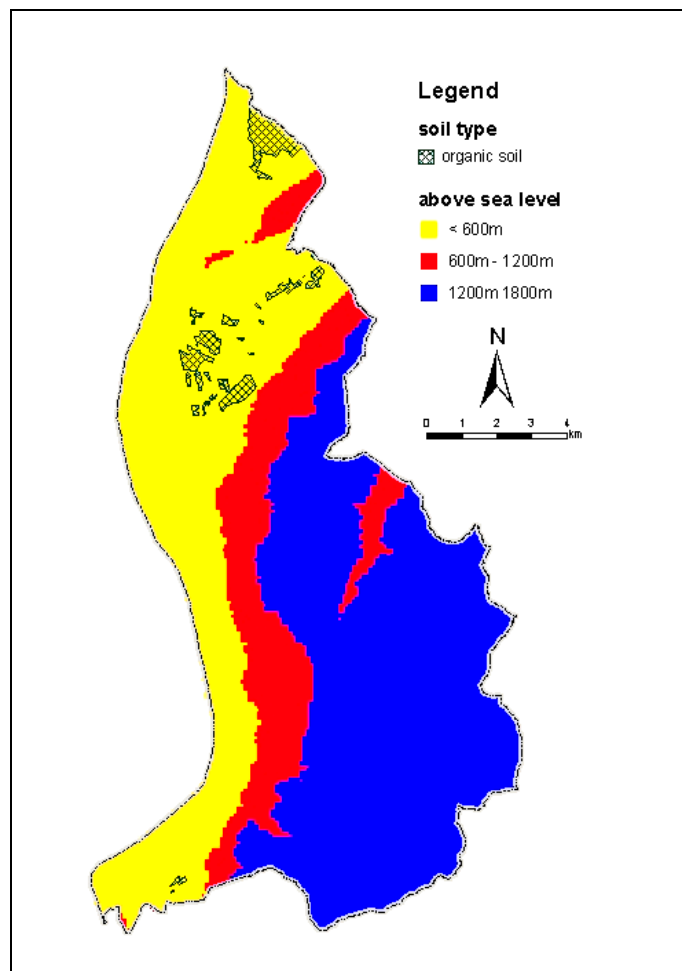

Figure 7-5 Map of Liechtenstein showing the altitude classes and soil types. Reference: OEP 2006d.

7.2.4 The Land-use Tables and Change Matrices (activity data)

Table 7-5 shows the overall trends of land-use changes between 1990 and 2011 for the source and sink categories according to the CRF.

Table 7-5 Statistics of land use for the whole period 1990-2011 (in ha) and change (absolute and relative) between 1990 and 2011. The table displays the data for the land-use categories remaining the same land-use category (excluding land converted to a specific category).

	1990	1991	1992	1993	1994	1995	1996	1997	1998	1999	2000	2001	2002
Forest land	6036	6048	6061	6074	6087	6100	6113	6112	6111	6110	6109	6108	6107
Cropland	1952	1948	1943	1938	1933	1928	1923	1916	1909	1902	1895	1888	1881
Grassland	5312	5287	5262	5237	5212	5187	5162	5149	5136	5123	5111	5098	5085
Wetlands	359	356	353	350	347	344	341	348	354	361	367	374	380
Settlements	1367	1384	1401	1418	1436	1453	1470	1489	1507	1526	1544	1563	1581
Other Land	1025	1028	1031	1033	1036	1038	1041	1037	1033	1028	1024	1020	1016
Sum	16050	16050	16050	16050	16050	16050	16050	16050	16050	16050	16050	16050	16050

	2003	2004	2005	2006	2007	2008	2009	2010	2011	Change 1990-2011 (ha)	Change 1990-2011 (%)
Forest land	6108	6116	6124	6132	6139	6131	6137	6143	6147	111.4	1.8%
Cropland	1895	1891	1886	1882	1877	1788	1779	1770	1761	-191.9	-9.8%
Grassland	5041	5019	4997	4975	4953	5056	5042	5028	5013	-298.1	-5.6%
Wetlands	378	378	378	378	379	363	363	364	364	5.2	1.5%
Settlements	1603	1621	1639	1657	1674	1691	1709	1727	1745	378.6	27.7%
Other Land	1025	1026	1026	1027	1028	1021	1021	1021	1020	-5.2	-0.5%
Sum	16050	16050	16050	16050	16050	16050	16050	16051	16050	0.0	0.0%

The most significant land-use changes in absolute terms since 1990 can be observed in the categories cropland (decrease by 9.8%), grassland (-5.6%) and settlements (increase by 27.7%).

Table 7-6 shows the same trends at the level of the more disaggregated land-use categories. The data is resulting from interpolation and extrapolation in time and from spatial stratification (altitude classes and soil types). For example, the area of afforestations (combination category 11) decreases in all altitude classes between 68.4% and 100% from 1990 to 2011, while the area of managed forests (combination category 12) increases by 3.9% since 1990 in an altitude over 1200 m.

Table 7-6 Statistics of land use (CC = combination categories) for the whole period 1990-2011 (in ha) and change (absolute and relative) between 1990 and 2011. The table displays the data for the land-use categories remaining the same land-use category (excluding land converted to a specific category).

CC	altitude	soil type	1990	1991	1992	1993	1994	1995	1996	1997	1998	1999	2000	2001	2002
11	≤ 600	n.s.	8.5	9.1	9.7	10.2	10.8	11.4	12.0	10.7	9.3	8.0	6.7	5.3	4.0
	601-1200	n.s.	7.0	6.0	5.0	4.0	3.0	2.0	1.0	1.3	1.7	2.0	2.3	2.7	3.0
	> 1200	n.s.	29.0	29.5	30.0	30.5	31.0	31.5	32.0	28.8	25.7	22.5	19.3	16.2	13.0
12	≤ 600	n.s.	993.5	993.9	994.4	994.8	995.2	995.6	996.0	995.8	995.7	995.5	995.3	995.2	995.0
	601-1200	n.s.	1954.5	1955.4	1956.3	1957.2	1958.2	1959.1	1960.0	1958.0	1956.0	1954.0	1952.0	1950.0	1948.0
	> 1200	n.s.	2157.5	2164.1	2170.7	2177.2	2183.8	2190.4	2197.0	2199.5	2202.0	2204.5	2207.0	2209.5	2212.0
13	≤ 600	n.s.	0.5	0.6	0.7	0.7	0.8	0.9	1.0	0.8	0.7	0.5	0.3	0.2	0.0
	601-1200	n.s.	8.5	8.6	8.7	8.8	8.8	8.9	9.0	9.3	9.7	10.0	10.3	10.7	11.0
	> 1200	n.s.	876.5	881.3	886.0	890.8	895.5	900.3	905.0	907.7	910.3	913.0	915.7	918.3	921.0
21	n.s.	mineral	1828.5	1823.7	1819.0	1814.2	1809.5	1804.7	1800.0	1793.3	1786.7	1780.0	1773.3	1766.7	1760.0
	n.s.	organic	124.0	123.8	123.7	123.5	123.3	123.2	123.0	122.7	122.3	122.0	121.7	121.3	121.0
31	≤ 600	mineral	1132.0	1124.5	1117.0	1109.5	1102.0	1094.5	1087.0	1084.5	1082.0	1079.5	1077.0	1074.5	1072.0
	≤ 600	organic	63.0	62.7	62.3	62.0	61.7	61.3	61.0	61.0	61.0	61.0	61.0	61.0	61.0
	601-1200	mineral	364.5	362.6	360.7	358.8	356.8	354.9	353.0	351.8	350.7	349.5	348.3	347.2	346.0
	601-1200	organic	0.0	0.0	0.0	0.0	0.0	0.0	0.0	0.0	0.0	0.0	0.0	0.0	0.0
	> 1200	mineral	1666.5	1663.1	1659.7	1656.2	1652.8	1649.4	1646.0	1646.0	1646.0	1646.0	1646.0	1646.0	1646.0
	> 1200	organic	0.0	0.0	0.0	0.0	0.0	0.0	0.0	0.0	0.0	0.0	0.0	0.0	0.0
32	≤ 600	n.s.	20.0	20.2	20.3	20.5	20.7	20.8	21.0	21.5	22.0	22.5	23.0	23.5	24.0
	601-1200	n.s.	9.5	9.3	9.0	8.8	8.5	8.3	8.0	8.2	8.3	8.5	8.7	8.8	9.0
	> 1200	n.s.	563.0	556.0	549.0	542.0	535.0	528.0	521.0	519.3	517.7	516.0	514.3	512.7	511.0
33	n.s.	mineral	30.5	30.7	31.0	31.2	31.5	31.7	32.0	32.2	32.3	32.5	32.7	32.8	33.0
	n.s.	organic	0.0	0.0	0.0	0.0	0.0	0.0	0.0	0.0	0.0	0.0	0.0	0.0	0.0
34	≤ 600	n.s.	382.5	380.9	379.3	377.8	376.2	374.6	373.0	366.7	360.3	354.0	347.7	341.3	335.0
	601-1200	n.s.	79.5	79.1	78.7	78.2	77.8	77.4	77.0	76.0	75.0	74.0	73.0	72.0	71.0
	> 1200	n.s.	255.0	255.2	255.3	255.5	255.7	255.8	256.0	255.0	254.0	253.0	252.0	251.0	250.0
35	n.s.	mineral	0.5	0.4	0.3	0.3	0.2	0.1	0.0	0.0	0.0	0.0	0.0	0.0	0.0
	n.s.	organic	0.0	0.0	0.0	0.0	0.0	0.0	0.0	0.0	0.0	0.0	0.0	0.0	0.0
36	n.s.	n.s.	346.5	345.4	344.4	343.3	342.2	341.1	340.0	341.3	342.7	344.0	345.3	346.7	348.0
37	n.s.	n.s.	398.5	396.6	394.7	392.7	390.8	388.9	387.0	385.7	384.3	383.0	381.7	380.3	379.0
41	n.s.	n.s.	198.5	195.4	192.3	189.3	186.2	183.1	180.0	186.2	192.3	198.5	204.7	210.8	217.0
42	n.s.	n.s.	160.0	160.2	160.3	160.5	160.7	160.8	161.0	161.3	161.7	162.0	162.3	162.7	163.0
51	n.s.	n.s.	903.5	916.6	929.7	942.8	955.8	968.9	982.0	997.5	1013.0	1028.5	1044.0	1059.5	1075.0
52	n.s.	n.s.	304.5	306.4	308.3	310.2	312.2	314.1	316.0	318.7	321.3	324.0	326.7	329.3	332.0
53	n.s.	n.s.	15.0	14.3	13.7	13.0	12.3	11.7	11.0	12.2	13.3	14.5	15.7	16.8	18.0
54	n.s.	n.s.	143.5	146.4	149.3	152.2	155.2	158.1	161.0	160.2	159.3	158.5	157.7	156.8	156.0
61	n.s.	n.s.	1025.5	1028.1	1030.7	1033.2	1035.8	1038.4	1041.0	1036.8	1032.7	1028.5	1024.3	1020.2	1016.0
Sum			16050	16050	16050	16050	16050	16050	16050	16050	16050	16050	16050	16050	16050

CC-code	altitude	soil type	2003	2004	2005	2006	2007	2008	2009	2010	2011	Change 1990-2011 (ha)	Change 1990-2011 (%)	
11	≤ 600	n.s.	3.3	2.7	2.0	1.3	0.7	0.0	0.0	0.0	0.0	-8.5	-100%	
	601-1200	n.s.	2.7	2.3	2.0	1.7	1.3	1.0	0.7	0.3	0.0	-7.0	-100%	
	> 1200	n.s.	12.8	12.7	12.5	12.3	12.2	12.0	11.1	10.1	9.2	-19.8	-68.4%	
12	≤ 600	n.s.	994.7	994.3	994.0	993.7	993.3	993.0	993.0	992.9	992.9	-0.6	-0.1%	
	601-1200	n.s.	1947.7	1947.3	1947.0	1946.7	1946.3	1946.0	1945.5	1945.1	1944.6	-9.9	-0.5%	
	> 1200	n.s.	2215.0	2218.0	2221.0	2224.0	2227.0	2230.0	2234.0	2238.1	2242.1	84.6	3.9%	
13	≤ 600	n.s.	0.2	0.3	0.5	0.7	0.8	1.0	1.0	1.1	1.1	0.6	117.5%	
	601-1200	n.s.	11.0	11.0	11.0	11.0	11.0	11.0	11.1	11.3	11.4	2.9	34.3%	
	> 1200	n.s.	923.7	926.3	929.0	931.7	934.3	937.0	940.4	943.7	947.1	70.6	8.1%	
21	n.s.	mineral	1745.0	1730.0	1715.0	1700.0	1685.0	1670.0	1661.2	1652.4	1643.6	-184.9	-10.1%	
	n.s.	organic	120.5	120.0	119.5	119.0	118.5	118.0	117.7	117.3	117.0	-7.0	-5.6%	
31	≤ 600	mineral	1076.8	1081.7	1086.5	1091.3	1096.2	1101.0	1099.3	1097.6	1095.8	-36.2	-3.2%	
	≤ 600	organic	61.5	62.0	62.5	63.0	63.5	64.0	64.1	64.1	64.2	1.2	1.8%	
	601-1200	mineral	345.3	344.7	344.0	343.3	342.7	342.0	340.8	339.5	338.3	-26.3	-7.2%	
	601-1200	organic	0.0	0.0	0.0	0.0	0.0	0.0	0.0	0.0	0.0	0.0	0.0%	
	> 1200	mineral	1642.8	1639.7	1636.5	1633.3	1630.2	1627.0	1624.8	1622.6	1620.4	-46.1	-2.8%	
	> 1200	organic	0.0	0.0	0.0	0.0	0.0	0.0	0.0	0.0	0.0	0.0	0.0%	
32	≤ 600	n.s.	24.2	24.3	24.5	24.7	24.8	25.0	25.3	25.6	25.8	5.8	29.2%	
	601-1200	n.s.	9.5	10.0	10.5	11.0	11.5	12.0	12.1	12.3	12.4	2.9	30.7%	
	> 1200	n.s.	512.2	513.3	514.5	515.7	516.8	518.0	515.5	513.0	510.5	-52.5	-9.3%	
33	n.s.	mineral	33.0	33.0	33.0	33.0	33.0	33.0	33.1	33.3	33.4	2.9	9.6%	
	n.s.	organic	0.0	0.0	0.0	0.0	0.0	0.0	0.0	0.0	0.0	0.0	0.0%	
34	≤ 600	n.s.	330.7	326.3	322.0	317.7	313.3	309.0	304.9	300.8	296.8	-85.8	-22.4%	
	601-1200	n.s.	71.5	72.0	72.5	73.0	73.5	74.0	73.7	73.4	73.1	-6.4	-8.1%	
	> 1200	n.s.	248.8	247.7	246.5	245.3	244.2	243.0	242.3	241.7	241.0	-14.0	-5.5%	
35	n.s.	mineral	0.0	0.0	0.0	0.0	0.0	0.0	0.0	0.0	-0.1	-0.1	-0.6	-117%
	n.s.	organic	0.0	0.0	0.0	0.0	0.0	0.0	0.0	0.0	0.0	0.0	0.0%	
36	n.s.	n.s.	346.5	345.0	343.5	342.0	340.5	339.0	338.6	338.2	337.7	-8.8	-2.5%	
37	n.s.	n.s.	377.3	375.7	374.0	372.3	370.7	369.0	367.4	365.7	364.1	-34.4	-8.6%	
41	n.s.	n.s.	214.7	212.3	210.0	207.7	205.3	203.0	203.3	203.5	203.8	5.2	2.6%	
42	n.s.	n.s.	162.5	162.0	161.5	161.0	160.5	160.0	160.0	160.0	160.0	0.0	0.0%	
51	n.s.	n.s.	1089.7	1104.3	1119.0	1133.7	1148.3	1163.0	1177.4	1191.8	1206.2	302.7	33.5%	
52	n.s.	n.s.	338.0	344.0	350.0	356.0	362.0	368.0	371.5	375.1	378.6	74.1	24.3%	
53	n.s.	n.s.	18.7	19.3	20.0	20.7	21.3	22.0	22.4	22.8	23.2	8.2	54.4%	
54	n.s.	n.s.	153.0	150.0	147.0	144.0	141.0	138.0	137.7	137.4	137.1	-6.4	-4.5%	
61	n.s.	n.s.	1016.8	1017.7	1018.5	1019.3	1020.2	1021.0	1020.8	1020.5	1020.3	-5.2	-0.5%	
Sum			16050	16050	16050	16050	16050	16050	16050	16051	16051	1.4	0.0%	

Table 7-8 Carbon stocks and changes in biomass, dead organic matter and soils for the combination categories (CC), disaggregated for altitude and soil type. These values are valid for the whole period 1990-2011 (no annual changes) (FOEN 2006a).

CC-code	altitude zone z	soil type	carbon stock in living biomass (stockCl,i) 1990	carbon stock in dead organic matter (stockCd,i)	carbon stock in soil (stockCs,i)	growth of living biomass (increaseCl,i)	harvesting of living biomass (decreaseCl,i)	net change in dead organic matter (changeCd,i)	net change in soil (changeCs,i)
	Strata		Stocks (t C ha-1)			Changes (t C ha-1 yr-1)			
11	1	n.s.	12.35	0	75.30	2.56	0	0	0
	2	n.s.	6.70	0	75.30	1.70	0	0	0
	3	n.s.	2.41	0	75.30	0.85	0	0	0
12	1	n.s.	156.80	4.45	92.70	4.49	-3.05	0	0
	2	n.s.	152.16	4.01	92.70	4.18	-3.11	0	0
	3	n.s.	116.23	3.98	92.70	2.52	-2.06	0	0
13	1	n.s.	41.41	0	92.70	0	0	0	0
	2	n.s.	43.01	0	92.70	0	0	0	0
	3	n.s.	26.23	0	92.70	0	0	0	0
21	n.s.	0	5.66	0	53.40	0	0	0	0
	n.s.	1	5.66	0	240.00	0	0	0	-9.52
31	1	0	7.45	0	62.02	0	0	0	0
	1	1	7.45	0	240.00	0	0	0	-9.52
	2	0	6.26	0	67.50	0	0	0	0
	2	1	6.26	0	240.00	0	0	0	-9.52
	3	0	4.45	0	75.18	0	0	0	0
	3	1	4.45	0	240.00	0	0	0	-9.52
32	1	n.s.	11.60	0	68.23	0	0	0	0
	2	n.s.	11.60	0	68.23	0	0	0	0
	3	n.s.	11.60	0	68.23	0	0	0	0
33	n.s.	0	3.74	0	53.40	0	0	0	0
	n.s.	1	3.74	0	240.00	0	0	0	-9.52
34	1	n.s.	11.60	0	68.23	0	0	0	0
	2	n.s.	11.60	0	68.23	0	0	0	0
	3	n.s.	11.60	0	68.23	0	0	0	0
35	n.s.	0	24.63	0	64.76	0	0	0	0
	n.s.	1	24.63	0	240.00	0	0	0	-9.52
36	n.s.	n.s.	4.06	0	26.31	0	0	0	0
37	n.s.	n.s.	6.05	0	68.23	0	0	0	0
41	n.s.	n.s.	0	0	0	0	0	0	0
42	n.s.	n.s.	7.96	0	154.00	0	0	0	0
51	n.s.	n.s.	0	0	0	0	0	0	0
52	n.s.	n.s.	5.80	0	53.40	0	0	0	0
53	n.s.	n.s.	4.80	0	53.40	0	0	0	0
54	n.s.	n.s.	4.80	0	53.40	0	0	0	0
61	n.s.	n.s.	0	0	0	0	0	0	0

Legend

altitude zones:

- 1 < 600 m
 2 601 - 1200 m
 3 > 1200 m

soil type:

- 0 mineral soil
 1 organic soil

n.s. = no stratification

On organic soils, a value of 240 t C ha⁻¹ for stock C_s was assumed for all land-use categories (FOEN 2011, p. 257, based on Leifeld et al. (2003, 2005) . Where no stratification according to soil type is indicated (e.g. in CC 11,12,13), all soils including organic soils are allocated to

mineral soils. Thus, when calculating carbon changes in organic soils as a consequence of land-use changes, the difference of carbon stocks is always zero.

Carbon stock data for forests are derived from monitoring data of the Swiss National Forest Inventory NFI I; NFI II and NFI III. The data for agriculture, grassland and settlements are based on experiments, field studies, literature and expert estimates from Switzerland. For wetlands and other land, expert estimates or default values are available. The deduction of the individual values is explained in the following chapters.

7.3 Source Category 5A – Forest Land

7.3.1 Source Category Description

Key source 5A1

CO₂ emissions and removals from 5A1 Forest Land remaining Forest land are a key source by level and trend. Source category 5A2 “Land converted to Forest Land” is a key source by level.

38% of the total area of Liechtenstein is forest land. The total area of forest land increased by 1.8% between 1990 and 2011. The annual net CO₂ removals range from 18.34 Gg CO₂ (2003) to 19.68 Gg CO₂ (1997). The source category 5A1 “Forest Land remaining Forest Land” is by far the most relevant source category accounting for over 99% of net CO₂ removals from forest land.

All of the forest land is temperate forest. The definition of forest land is originally based on the Swiss definition and was revised after the In-Country Reviews carried out in Switzerland and Liechtenstein 2007. Forest land is now defined as follows (OEP 2007b):

- Minimum area of land: 0.0625 hectares with a minimum width of 25 m
- Minimum crown cover: 20%
- Minimum height of the dominant trees: 3 m (dominant trees must have the potential to reach 3 m at maturity in situ)

For reporting in the CRF tables, forest land was subdivided into afforestations (CC 11), managed forest (CC 12) and unproductive forest (CC 13) based on the land use and land cover categories (see Table 7-3, FOEN 2006b; SFSO 2006a).

7.3.2 Methodological Issues

7.3.2.1 Forest Land remaining Forest Land (5A1)

The activity data collection follows the methods described in chapter 7.2.2. Carbon stocks and carbon stock changes are taken from Switzerland. Details are described in the following paragraphs.

a) Swiss National Forest Inventories (NFI)

Data for growing stock, gross growth, cut (harvesting), and mortality was derived from the first and the second Swiss National Forest Inventory (see Table 7-9). The NFI I was conducted between 1983 and 1985 (EAFV/BFL 1988), the NFI II was conducted between 1993 and 1995 (Brassel and Brändli 1999).

Table 7-9 Characteristics of the Swiss National Forest Inventories I, II and III.

	NFI I	NFI II	NFI III
Inventory cycle	1983-1985	1993-1995	2004-2006
Grid size	1 x 1 km ²	1.4 x 1.4 km ²	1.4 x 1.4 km ²
Terrestrial sample plots	~12'000	~6'000	~6'000
Measured single trees	~130'000	~70'000	~70'000

b) Stratification, Spatial strata

As in Switzerland, forests in Liechtenstein reveal a high heterogeneity in terms of elevation, growth conditions, and tree species composition. To find explanatory variables that significantly reduce the variance of gross growth and biomass expansion factors (BEFs) an analysis of variance was done in Switzerland (Thürig and Schmid 2007). The explanatory variables considered are (see also 7.2.3):

- altitude (≤ 600 m, 601-1200 m, > 1200 m)
- tree species (coniferous and deciduous species).

In Liechtenstein, most forests are mixed stands. It was assumed that the mix between coniferous and deciduous species in different altitudes is identical as in the prealpine region of Switzerland (no national data considered).

In Switzerland, the forest area derived by the land use statistics does not allow separating coniferous and deciduous sites. If species specific measures for growing stock, gross growth, harvesting and BEFs are to be applied, the total forest area has to be divided according to the species mixture. It was assumed that the space asserted by a single tree is highly correlated with its basal area. The required ratio of coniferous forest area (R_c) per spatial stratum (Table 7-10) was calculated by dividing the sum of the basal area of the conifers (BA_c) over the sum of the basal area of all trees (BA).

$$R_{ci} = BA_{ci} / BA_i \quad i = \text{spatial strata}$$

As both species add up to 1 (or 100%) the rate of deciduous forest area (R_d) is:

$$R_{di} = 1 - R_{ci} \quad i = \text{spatial strata}$$

The following Swiss ratio of coniferous and deciduous species per altitude class was applied:

Table 7-10 Ratio of coniferous and deciduous species (source: NFI II; Brassel and Brändli 1999).

Altitude [m]	Coniferous	Deciduous
≤ 600	0.395	0.605
601-1200	0.713	0.287
> 1200	0.925	0.075

c) Biomass Expansion Factors (BEF)

The Swiss Biomass Expansion Factors were applied in Liechtenstein (FOEN 2008).

In the Swiss National Forest Inventory, growing stock, gross growth, cut (harvesting) and mortality is expressed as round wood over bark. Round wood over bark was expanded to total biomass as done in Thürig et al. (2005) by applying allometric single-tree functions to all trees measured at the NFI II. BEFs were then calculated for each spatial stratum as the ratio

between round wood over bark ($\text{m}^3 \text{ha}^{-1}$) and the total above- and belowground biomass (t ha^{-1}). Table 7-11 shows the BEFs for coniferous and deciduous species stratified for altitude.

Table 7-11 Biomass expansion factors (BEFs) to convert round-wood over bark ($\text{m}^3 \text{C ha}^{-1}$) to total biomass (t C ha^{-1}) for conifers and deciduous species, respectively (Thürig et al. 2005).

Altitude [m]	Conifers		Deciduous species	
	Number of trees measured	BEFs	Number of trees measured	BEFs
≤ 600	129	1.48	239	1.49
601-1200	4220	1.48	1980	1.49
> 1200	2909	1.59	241	1.56

d) Wood Densities

To convert round wood over bark ($\text{m}^3 \text{ha}^{-1}$) into t ha^{-1} it was multiplied by a species-specific density. Table 7-12 shows the applied densities.

Table 7-12 Wood densities for coniferous and deciduous trees (Vorreiter 1949).

	Wood density [t m^{-3}]
Coniferous trees	0.40
Deciduous trees	0.55

e) Carbon Content

The IPCC default carbon content of solid wood of 50% was applied (IPCC 2003; p. 3.25).

f) Growing Stock, Gross Growth and Cut & Mortality in Managed Forests (CC 12)

The Swiss values for growing stock, gross growth, cut and mortality were applied in Liechtenstein (FOEN 2008).

Growing stock, gross growth, cut and mortality for managed forests were derived from those 5'425 sample plots measured at both Swiss National Forest Inventories NFI I and NFI II (Kaufmann 2001). All values derived from the NFI I and II are related to round wood over bark (with stock, without branches) and are given in $\text{m}^3 \text{ha}^{-1}$ per spatial stratum (see Table 7-13 and Table 7-14).

Table 7-13 Growing stock, gross growth, cut and mortality for coniferous trees (related to coniferous forest area).

Coniferous trees				
Altitude [m]	Growing stock 1985 [$\text{m}^3 \text{ha}^{-1}$]	Growing stock 1995 [$\text{m}^3 \text{ha}^{-1}$]	Gross growth [$\text{m}^3 \text{ha}^{-1} 10.1\text{yr}^{-1}$]	Cut and mortality [$\text{m}^3 \text{ha}^{-1} 10.1\text{yr}^{-1}$]
≤ 600	473.58	506.79	132.36	99.14
601-1200	482.43	515.95	132.71	98.85
> 1200	356.09	372.59	76.12	59.58

Note: 10.1 years correspond to the average inter-survey period between NFI I and NFI II; see below.

Table 7-14 Growing stock, gross growth, cut and mortality for deciduous trees (related to deciduous forest area).

Deciduous trees				
Altitude [m]	Growing stock 1985 [m ³ ha ⁻¹]	Growing stock 1995 [m ³ ha ⁻¹]	Gross growth [m ³ ha ⁻¹ 10.1yr ⁻¹]	Cut and mortality [m ³ ha ⁻¹ 10.1yr ⁻¹]
≤ 600	379.93	427.12	115.75	68.56
601-1200	374.75	427.88	113.4	60.82
>1200	257.27	311.7	72.32	17.88

Note: 10.1 years correspond to the average inter-survey period between NFI I and NFI II; see below.

Conversion of NFI data to annual estimates of gross growth and cut & mortality

The average inter-survey period between the Swiss NFI I and NFI II is not exactly 10 years, but 10.1 years. With regard to the individual spatial strata, the variance is even larger (Table 7-15).

Table 7-15 Average inter-survey period [in years] between NFI I and NFI II for all spatial strata.

Altitude		
≤ 600 m	601 m-1200 m	> 1200 m
10.4	10.1	10.0

To convert gross growth and cut & mortality measured between NFI I and II into average annual gross growth and average annual cut & mortality, those data had to be divided by the time periods shown in Table 7-15

[annual gross growth]_i = [gross growth between NFI I and II]_i / time period_i

[annual cut & mortality]_i = [cut & mortality between NFI I and II]_i / time period_i

where i indicates the different altitudes.

Annual cut and mortality

In order to simplify the estimation of annual cut and mortality, it is assumed that the annual cut and mortality is constant over the whole time period. This is in difference to the Swiss calculation, where different annual cut and mortality amounts are estimated. Liechtenstein applies the Swiss values for the year 1990 for all years between 1990 and 2011.

To calculate the annual cut and mortality (CMy) for the year 1990, the total amount of cut and mortality was distributed among the ten years between 1986 and 1995 and weighted by the percentage of the annual harvesting amounts taken from the forest statistic (SFSO 2006b, SAEFL 2005b).

The annual cut and mortality for coniferous and deciduous trees is as follows:

Table 7-16 Annual cut and mortality for coniferous trees in m³ ha⁻¹ and t C ha⁻¹ (value for 1990, applied for all years).

Coniferous trees		
Altitude [m]	Annual cut and mortality [m ³ ha ⁻¹]	Annual cut and mortality [t C ha ⁻¹]
≤ 600	11.34	3.36
601-1200	11.3	3.35
> 1200	6.81	2.17

Table 7-17 Annual cut and mortality for deciduous trees in $\text{m}^3 \text{ha}^{-1}$ and t C ha^{-1} (value for 1990, applied for all years).

Deciduous trees		
Altitude [m]	Annual cut and mortality [$\text{m}^3 \text{ha}^{-1}$]	Annual cut and mortality [t C ha^{-1}]
≤ 600	6.95	2.85
601-1200	6.16	2.53
> 1200	1.81	0.78

Gross growth

It is assumed that the growth rate of living biomass is constant over the whole time period. Liechtenstein applies the Swiss annual growth values for the year 1990 for all the years between 1990 and 2011. These values are displayed in Table 7-18.

$X_{j,i} = X_{j,i-1} + \text{annual growth of living mass in altitude } j \text{ (constant)} - \text{annual harvesting of living mass in altitude } j \text{ (constant)}$; i runs from 1991 to 2011.

Table 7-18 Growing stock of managed forests (CC12) 1990-2011 in t C ha^{-1} .

Growing C stocks of managed forests (CC 12) 1990-2011													
Altitude	carbon stock in living biomass (stock $_{C,i}$)												
	1990	1991	1992	1993	1994	1995	1996	1997	1998	1999	2000	2001	2002
≤ 600 m	156.8	158.2	159.7	161.1	162.6	164.0	165.5	166.9	168.3	169.8	171.2	172.7	174.1
601-1200 m	152.2	153.2	154.3	155.4	156.4	157.5	158.6	159.7	160.7	161.8	162.9	163.9	165.0
> 1200 m	116.2	116.7	117.1	117.6	118.1	118.5	119.0	119.5	119.9	120.4	120.8	121.3	121.8

Altitude											annual growth of living biomass (increase)	annual harvesting of living biomass (decrease)	Δ annual change
	2003	2004	2005	2006	2007	2008	2009	2010	2011				
≤ 600 m	175.6	177.0	178.4	179.9	181.3	182.8	184.2	185.7	187.1	4.5	-3.05	1.44	
601-1200 m	166.1	167.2	168.2	169.3	170.4	171.4	172.5	173.6	174.6	4.2	-3.11	1.07	
> 1200 m	122.2	122.7	123.1	123.6	124.1	124.5	125.0	125.4	125.9	2.5	-2.06	0.46	

g) Growing C Stocks in Unproductive Forests (CC 13)

The unproductive forest in Liechtenstein mainly consists of brush forest and inaccessible forest. Although unproductive, this type of forest is still categorized as managed forest. The same carbon stock per hectare as in Switzerland is assumed.

Brush forest

No data from the Swiss National Forest Inventory (NFI) are available to derive their growing stock. Brush forests mainly consist of *Alnus viridis* and horizontal *Pinus mugo* var. *prostrata*. Therefore, following estimations were made:

Average growing stock: 4000 trees per ha, average height of 2.5 m and an average diameter at 1.3 m of 10 cm. Hence, an average growing stock (> 7 cm diameter) of $40 \text{ m}^3 \text{ha}^{-1}$ was estimated (FOEN 2011),

Wood density for coniferous trees: 0.4 t m^{-3} (Vorreiter 1949)

BEF: 1.45 (Burschel et al. 1993)

Carbon content: 50% (IPCC default carbon content)

Carbon stock : $11.6 \text{ t C ha}^{-1} = 40 \text{ m}^3 \text{ ha}^{-1} * 0.4 \text{ t m}^{-3} * 1.45 * 0.5$

(C stock in living biomass = Average growing stock * density * BEF * C-content)

Inaccessible forest

Inaccessible forest in Liechtenstein is mainly located in higher altitudes (above 1200 m). No data from the Swiss National Forest Inventory (NFI) are available to derive the stock growth. Therefore, the following assumptions were made:

Average growing stock: Inaccessible forest is located in the Alps where the average growing stock is around $318 \text{ m}^3 \text{ ha}^{-1}$ and $219 \text{ m}^3 \text{ ha}^{-1}$, respectively (Brassel and Brändli 1999). As those forests are assumed to grow preferably on bad site conditions, an average growing stock (> 7 cm diameter) of $150 \text{ m}^3 \text{ ha}^{-1}$ was estimated.

Wood density for coniferous trees: 0.4 t m^{-3} (Vorreiter 1949)

BEF: 1.45 (Burschel et al. 1993)

Carbon content: 50% (IPCC default carbon content)

Carbon stock : $43.5 \text{ t C ha}^{-1} = 150 \text{ m}^3 \text{ ha}^{-1} * 0.4 \text{ t m}^{-3} * 1.45 * 0.5$

(C stock in living biomass = Average growing stock * density * BEF * C-content)

Carbon content of unproductive forests (CC 13): Weighted means

The carbon content of unproductive forest was calculated as a weighted average of brush forest and inaccessible forest per spatial stratum:

$[\text{weighted C content}]_i = \text{RS}_i * \text{CS} + (1 - \text{RS}_i) * \text{CI}$

where RS_i is the rate of the brush forest per spatial stratum i ,

CS is the carbon content of brush forest (11.6 t C ha^{-1}),

CI is the carbon content of inaccessible forest (43.5 t C ha^{-1}).

Table 7-19 shows the carbon content per altitude class in t C ha^{-1} .

Table 7-19 Rate of brush forest and inaccessible forest and the resulting weighted carbon content in t C ha^{-1} of Swiss unproductive forests (CC 13) specified for all spatial strata.

Altitude [m]	Rate of brush forest	Rate of inaccessible forest	Weighted C content [t C ha^{-1}]
≤ 600	0.066	0.934	41.41
601-1200	0.015	0.985	43.01
> 1200	0.541	0.459	26.23

* Derived from the NFI II (Brassel and Brändli 1999)

g) Dead Wood in managed forests (CC 12)

The Swiss carbon stock amounts per hectare are applied in Liechtenstein.

In the second Swiss NFI, all dead trees (standing and lying) larger than 12 cm in diameter were measured. Thus, an estimate of the dead-wood pool in Swiss managed forests (CC 12) can be done.

Table 7-20 Dead wood in Swiss managed forests (CC12) (Brassel and Brändli 1999).

	Dead wood [m ³ ha ⁻¹]
Lying trees	3.7
Standing trees	8.4
Total	12.2

Applying the same wood densities, BEFs and carbon content as for the living growing stock, dead wood per spatial stratum can be estimated (Table 7-21).

Table 7-21 Dead wood in managed forests (CC12) per altitude class in t C ha⁻¹.

Altitude [m]	Carbon in dead biomass [t C ha ⁻¹]
≤ 600	4.45
601-1200	4.01
> 1200	3.98

g) Carbon Stock of Afforestations (CC 11)

Growing stock and growth

The Swiss growing stock and growth rates are applied in Liechtenstein. The following paragraph gives some further explanations about the Swiss calculation of carbon stock changes.

Swiss methodology (excerpt from NIR CH, chpt. 7.3.2, FOEN 2007):

The average growing stock and growth of afforestations were empirically assessed with NFI I and II, specifically with those stands that were approximately 10 years old in the first NFI and 20 years old in the second NFI. The average growing stock of those 20 year old stands was derived from NFI II. The NFI data were therefore stratified for site quality. It was assumed that forest areas below 600 m show a good site quality, areas between 600 and 1200 m a moderate site quality, and forest areas above 1200 m show a poor site quality. The growing stock of forest stands on good sites was 90 m³ ha⁻¹. The growing stock on moderate sites was assumed to be one-third smaller than on good sites (60 m³ ha⁻¹), and two-third smaller on bad sites (30 m³ ha⁻¹). As trees below 12 cm DBH were not measured in the NFI, the growing stock of 10 year old stands on good sites was assumed to be 2 m³ ha⁻¹. Within the first few years of stand age, the growing stock was assumed to develop exponentially. The development of the growing stock on good sites between 10 and 20 years was therefore simulated by calibrating an exponential growth function. To simulate the development of growing stock on intermediate and poor sites, growing stock was assumed to develop one-third slower on intermediate, and two-third slower on poor sites. The annual growth was calculated as the difference between growing stocks of two following years. These assumptions are not valid for single stands, but can be applied as a rough simplification¹⁷.

¹⁷ As these assumptions stem from a modeling approach with a growth function (based on the LFI's), they cannot be used in a small scale, isolated observation, as for example for small patches of forest (single stands).

Table 7-22 shows the simulated growing stock and growth for all three site qualities.

Table 7-22 Estimated average growing stock and annual growth of forest stands in stemwood (defined in Table 24) up to 20 years (CC11) specified for altitude zone.

Stand age [yr]	≤ 600 m altitude		601 - 1200 m altitude		> 1200 m altitude	
	Growing stock [m ³ ha ⁻¹]	Growth [m ³ ha ⁻¹ year ⁻¹]	Growing stock [m ³ ha ⁻¹]	Growth [m ³ ha ⁻¹ year ⁻¹]	Growing stock [m ³ ha ⁻¹]	Growth [m ³ ha ⁻¹ year ⁻¹]
0-9	0	0	0	0	0	0
10	2	2	0	0	0	0
11	7	5	0	0	0	0
12	13	6	1	1	0	0
13	19	6	5	4	0	0
14	27	8	10	5	0	0
15	35	8	16	6	1	1
16	44	9	23	7	5	4
17	54	10	31	8	10	5
18	66	12	40	9	16	6
19	78	12	50	10	23	7
20	90	12	60	10	30	7

To convert the estimated growing stock and growth into carbon, the following equations were applied:

$$C \text{ stock in living biomass} = \text{Average growing stock} * \text{density} * \text{BEF} * \text{C-content}$$

$$\text{Growth of living biomass} = \text{Average growth} * \text{density} * \text{BEF} * \text{C-content}$$

In Table 7-23, abbreviations and units are explained. Table 7-24 shows the parameters and the converted values.

Table 7-23 Conversion of growing stock and growth to total carbon in biomass.

Name	Description	Value	Unit
Average growing stock	Average growing stock of stemwood over bark, without branches	See Table 7-24	m ³ ha ⁻¹
Average growth	Average growth per ha and year	See Table 7-24	m ³ ha ⁻¹ year ⁻¹
Density	Tree density averaged for coniferous and deciduous trees	0.47	t m ⁻³
BEF	Biomass expansion factor to convert stemwood over bark into total tree biomass (Burschel et al. 1993); averaged value for coniferous and deciduous trees.	1.45	-
C-content	Carbon to total biomass ratio (IPCC default)	0.5	-
C stock in living biomass	Carbon content in total above- and belowground biomass	See Table 7-24	t C ha ⁻¹
Growth of living biomass	Growth of carbon in t C per ha and year	See Table 7-24	t C ha ⁻¹ year ⁻¹

Table 7-24 Carbon stock in living biomass and growth of living biomass in afforestations (CC11) specified for altitude zone.

Altitude [m]	Average growing stock [m³ ha⁻¹]	Average growth [m³ ha⁻¹ year⁻¹]	Density [t m⁻³]	BEF	Carbon content	Carbon stock in living biomass [t C ha⁻¹]	Growth of living biomass [t C ha⁻¹ year⁻¹]
≤ 600	36.25	7.5	0.47	1.45	0.5	12.35	2.56
601-1200	19.67	5	0.47	1.45	0.5	6.70	1.70
> 1200	7.08	2.5	0.47	1.45	0.5	2.41	0.85

h) Soil carbon in Managed Forests (CC12), Unproductive Forests (CC13) and Afforestations (CC11)

According to a study of Perruchoud et al. (2000), a carbon stock of mineral forest soils of 76 t C ha⁻¹ in 0-30 cm topsoil is assumed for the pre-alpine region (which also covers the area of Liechtenstein).

The soil horizons L (litter), F (fermentation) and H (humus) were not included in the soil samples analyzed by Perruchoud et al. (2000). However, especially in forests, those horizons may contain substantial amounts of carbon and should be included in the estimation of forest soil carbon. In a study done by Moeri (2007) soil carbon of organic soil horizons on mineral soils were estimated. According to this study, the soil carbon in these soil horizons in the pre-alpine region, which is relevant for Liechtenstein, is 17.4 t C ha⁻¹. Further details are displayed in Table 7-25.

Table 7-25 Soil organic carbon of mineral forest soils (CC12, CC13) in organic soil horizons in t C ha⁻¹ in the pre-alpine region. The average values ± standard deviation are given.

	L Horizon	F Horizon	H Horizon	Total
Soil carbon (in t C ha⁻¹)	4.4 (± 3.2)	6.4 (± 9.4)	6.6 (± 19.8)	17.4 (± 28.5)

Unlike stated in the GPG LULUCF (IPCC 2003), soil carbon of mineral forest soils in organic soil horizons was added to the soil carbon of the mineral layer for Swiss managed and unproductive forests (CC 12 and CC 13). According to IPCC (2003; Table 3.1.2) soil carbon of the organic soil horizons should be accounted as dead organic matter, together with dead wood.

For afforestations (CC 11), the amount of soil carbon in the soil organic horizons was assumed to be zero. Total soil carbon for afforested land was defined as soil carbon contained in the 0-30 cm mineral topsoil.

Due to following reasons it is assumed that in the years 1990 to 2010 forest soils in Switzerland as well as in Liechtenstein were no source of carbon:

- Within the last decades, no drastic changes of management practices in forests have been taken place due to restrictive forest laws.
- Fertilization of forests is prohibited in Liechtenstein. Drainage of forests is not common practice in Liechtenstein.
- As growing stock has increased since many years, soil carbon is assumed to increase due to increasing litter production.
- As shown in the study by Thürig et al. (2005), wind-throw may have a slightly increasing effect on soil carbon. However, this study neglected the effect of soil disturbances which could equalize those effects.

i) N₂O Emissions from N Fertilization and Drainage of Soils

Fertilization of forests is prohibited by law in Liechtenstein. Therefore, no emissions are reported in CRF Table 5(I).

Drainage of forests is not common practice in Liechtenstein. As a first guess drainage activity was set to zero, and no emissions are reported for forest land in CRF Table 5(II).

j) Emissions from Wildfires

Controlled burning of forests is not allowed in Liechtenstein. Wildfires affecting forest did not occur in Liechtenstein since 1985 as confirmed by Nigsch (2012). Therefore no emissions are reported for forest land in CRF Table 5 (V).

7.3.2.2 Land converted to Forest Land (5A2)

According to the land use statistic the areas switching to forest land are mainly areas that used to be grassland or woody biomass (Table 7-7, combination category 32) not fulfilling the definition of minimal forest density and area.

The carbon fluxes in case of land-use change comprising forest land are specified as follows:

According to the stock change approach, the growing stock of e.g. shrub vegetation (CC 32; living biomass and soil carbon) should be subtracted and the average growing stock of forests should be added. However, these forests are supposed to have a growing stock smaller than the growing stock of an average forest and adding the average growing stock of forest areas would possibly overestimate the carbon increase. In terms of IPCC good practice a conservative assumption was met (see also Chapter 7.2.1): The amount of living biomass (carbon stock in living biomass) on land changing from non-forest to forest was not increased but left unchanged. The annual increase of biomass (carbon flux) on these areas was approximated by the annual gross growth rate of the respective forest type (CC 11, 12 or 13). The change of soil carbon was not considered and was set to zero.

Cut and mortality was inferred from the Swiss land-use statistics NFI I and NFI II, applying the stock change approach on forest areas remaining forest. Thus, the total harvesting amount was already considered. To avoid double-counting of the harvesting amount on areas changing from non-forested to forested areas, no additional loss in terms of cut and mortality was accounted for, but the converted areas were only multiplied with the average annual gross growth of the respective spatial stratum.

The annual area of forest changing to other land use categories was also derived by land use statistics. To account for the "decrease of carbon", above- and belowground biomass, the amount of dead-wood and the amount of soil carbon of forest areas changing into other land use categories were subtracted. To account for the "increase of carbon", the carbon stock in biomass and soil of the new land use category was added.

7.3.3 Uncertainties and Time-Series Consistency

The uncertainty for the Key Category 5A1 is 5% for AD. For the EF (CO₂) it is 36% according to the Swiss National Inventory Report (FOEN 2011), see also chapter 1.7 for uncertainty evaluation. The uncertainty of gross growth, cut and mortality is assessed as low. In case of BEFs, the uncertainty is assessed as medium. In case of soil carbon pool, the uncertainty is assessed as medium (FOEN 2011).

Time series are consistent.

7.3.4 Source-Specific QA/QC and Verification

The source-specific QA/QC activities have been carried out as mentioned in sections 1.6.1.4 and 1.6.1.5 including also the triple check of the CRF tables (detailed comparison of latest with previous data for the base year, for 2010 and for the changing rates 2010/2011).

The LULUCF expert, the NIC and the NIR author report their QC activities in a checklist (see Annex 8).

7.3.5 Source-Specific Recalculations

All data 1990-2011 have been recalculated as follows: The area in 5A2 is now cumulated during 20 years (instead of 1 year). As a consequence, the areas are larger in 5A2 and smaller in 5A1 than before. Overall, the amount of losses is smaller because there is no harvesting in the young forests reported in 5A2.

7.3.6 Source-Specific Planned Improvements

No source-specific improvements are planned.

7.4 Source Category 5B – Cropland

7.4.1 Source Category Description

Key source 5B1

Emissions from 5B1 Cropland remaining Cropland are a key source by level. Source category 5B2 "Land converted to Cropland" is not a key source.

11% of Liechtenstein's total surface is cropland. Land use changes to cropland or from cropland are not very common. The most important changes are from grassland to cropland on the one hand and from cropland to grassland and settlements on the other hand. The total area of cropland decreased by 9.8% between 1990 and 2011.

Croplands in Liechtenstein belong to the cold temperate wet climatic zone. Carbon stocks in aboveground living biomass and carbon stocks in mineral and organic soils are considered. Croplands (CC 21) and include annual crops and leys in arable rotations.

7.4.2 Methodological Issues

7.4.2.1 Cropland remaining Cropland (5B1)

The activity data collection follows the methods described in chapter 7.2.2. Carbon stocks and carbon stock changes are taken from Switzerland. Details are described in the following paragraphs.

a) Carbon in Living Biomass

When cropland remains cropland, the carbon stocks of annual crops are not considered since they are harvested every year. Thus, there is no long-term carbon storage.

b) Carbon in Soils

The Swiss mean soil organic carbon stocks for cropland ($53.40 \pm 5 \text{ t C ha}^{-1}$) and for cultivated organic soils ($240 \pm 48 \text{ t C ha}^{-1}$) were applied in Liechtenstein. Both are based on studies from Leifeld et al. (2003) and Leifeld et al. (2005).

c) Changes in Carbon Stocks

Changes in carbon stocks in organic soil for cropland remaining cropland are due to a loss of 9.52 t C/ha/yr .

Carbon stock changes in soil for cropland due to changes from mineral to organic soil are not estimated in Liechtenstein since data on mineral and organic soils is only available for one year. Changes can therefore not be estimated.

d) Carbon Emissions from Agricultural Lime Application

Emissions from lime application are not occurring in Liechtenstein.

7.4.2.2 Land converted to Cropland (5B2)

The activity data collection follows the methods described in chapter 7.2.2.. Carbon factors are displayed in the following paragraphs.

a) Carbon in Living Biomass

When a conversion of a land to cropland occurs, carbon stocks of annual crops are taken into account. This is in line with the Good Practice Guidance LULUCF (IPCC 2003, p. 3.88, table 3.3.8).

The Swiss mean biomass stock for cropland of 5.66 t C ha^{-1} was applied in Liechtenstein. The value is based on area-weighted means of standing stocks at harvest for the seven most important annual crops (wheat, barley, maize, silage maize, sugar beet, fodder beet, potatoes; FOEN 2007).

b) Carbon in Soils

As mentioned under the source category "Cropland remaining cropland" the Swiss mean soil organic carbon stocks for cropland ($53.40 \pm 5 \text{ t C ha}^{-1}$) and for cultivated organic soils ($240 \pm 48 \text{ t C ha}^{-1}$) were applied in Liechtenstein.

c) N₂O Emissions from Land Use Conversion to Cropland

N₂O emissions as a result of the disturbance associated with land-use conversion to cropland are reported in CRF Table 5 (III). The emissions are calculated with default values proposed by IPCC (2003, following Equations 3.3.14 and 3.3.15, and Chapter 3.3.2.3.1.2):

$$\text{Emission (N}_2\text{O)} = -1 * \text{deltaC}_s * (1 / (\text{C:N})) * \text{EF1} * (44 / 28) \quad [\text{Gg N}_2\text{O}]$$

where:

deltaC_s: soil carbon difference in soils induced by land-use conversion to cropland
[Gg C]

C:N: IPCC default C:N ratio = 15 in forest or grassland soils

EF1: IPCC default emission factor = $0.0125 \text{ kg N}_2\text{O-N (kg N)}^{-1}$

Where negative emissions would occur (when the ΔC_s is positive), they are set to zero and “NO” is reported in the CRF (e.g. when Other Land is converted to Cropland).

7.4.3 Uncertainties and Time-Series Consistency

The uncertainty for the Key Category 5B1 is 30% for AD. For the EF (CO₂) it is 25% according to the Swiss National Inventory Report (FOEN 2011), see also chapter 1.7 for uncertainty evaluation.

Where available, uncertainties for soil carbon stocks are given together with the mean value in the text. The relative uncertainty in yield determination has been estimated at 13% for biomass carbon from agricultural land (Leifeld et. al. 2005). Data on biomass yields for different elevations and management intensities as published by FAL/RAC (2001) are based on many agricultural field experiments and have a high reliability.

The time-series are consistent.

7.4.4 Source-Specific QA/QC and Verification

The source-specific QA/QC activities have been carried out as mentioned in sections 1.6.1.4 and 1.6.1.5 including also the triple check of the CRF tables (detailed comparison of latest with previous data for the base year, for 2010 and for the changing rates 2010/2011).

The LULUCF expert, the NIC and the NIR author report their QC activities in a checklist (see Annex 8). No additional source-specific QA/QC activities have been carried out.

7.4.5 Source-Specific Recalculations

All data 1990-2011 have been recalculated as follows:

The area in 5B2 is now cumulated during 20 years (instead of 1 year). As a consequence, the areas are larger in 5B2 and smaller in 5B1 than before.

In the CRF tables, the areas and the emissions from organic soils are now reported separately. In former submissions, mineral and organic soils were reported only on an aggregated level.

An error in the formula for calculating the N₂O emissions as a result of the disturbance associated with land-use conversion to cropland (CRF Table 5(III)) was corrected. This correction lead to higher emissions.

7.4.6 Source-Specific Planned Improvements

No source-specific improvements are planned.

7.5 Source Category 5C – Grassland

7.5.1 Source Category Description

Key source 5C1 and 5C2

Emissions from 5C1 “Grassland remaining Grassland” are not a key source. Source category 5C2 “Land converted to Grassland” is a key source concerning level and trend.

31% of Liechtenstein’s total surface is grassland, whereof 85.9% is managed and 14.1% is unmanaged grassland. Conversion to grassland occurs mainly from cropland to grassland and from forest to grassland. These changes are however less important than the reverse

conversion from grassland to forest and from grassland to cropland. The total area of grassland decreased by 5.6% in 2011 compared to 1990.

Liechtenstein's grasslands belong to the cold temperate wet climatic zone. Carbon stocks in living biomass and carbon stocks in soils are considered. Grasslands include permanent grassland (CC 31), shrub vegetation (CC 32), vineyards, low-stem orchards ('Niederstammobst') and tree nurseries (CC 33), copse (CC 34), orchards ('Hochstammobst'; CC 35), stony grassland (CC 36), and unproductive grassland (CC 37). The combination categories CC 31-35 are considered as managed and CC 36-37 as unmanaged grasslands.

7.5.2 Methodological Issues

7.5.2.1 Grassland remaining Grassland (5C1)

The activity data collection follows the methods described in chapter 7.2.2. Carbon stocks are taken from Switzerland. Details are described in the following paragraphs.

a) Carbon in Living Biomass

Permanent Grassland (CC 31)

Permanent grasslands range in altitude from < 300 m to 3000 m above sea level. Because both biomass productivity and soil carbon rely on the prevailing climatic and pedogenic conditions, grassland stocks were calculated separately for three altitude zones (corresponding to those used in source category 5A - Forest Land).

Swiss values for carbon stock in living biomass of permanent grassland are applied (FOEN 2011). The estimation of carbon stocks is based on annual cumulative yield of differentially managed grasslands (FAL/RAC 2001) and on root biomass-C (Ammann et al. 2007). The values for the different altitude zones including roots are displayed in Table 7-26.

Table 7-26 Living biomass CI of permanent grassland (CC 31).

Altitude [m]	C _i [t C ha ⁻¹]
≤ 600	7.45
601-1200	6.26
>1200	4.45

Shrub Vegetation (CC 32) and Copse (CC 34)

Swiss values for living biomass in shrub vegetation and copse were applied (FOEN 2009). Due to a lack of more precise data, the living biomass of shrub vegetation and copse was assumed to correspond with brush forest described in section 7.3.2. Brush forest is assumed to contain 11.6 t C ha⁻¹.

Vineyards, Low-stem Orchards and Tree Nurseries (CC 33)

Swiss values for standing carbon stock of living biomass (CI) for CC 33 were applied (FOEN 2011). CI of vineyards is 3.61 t C ha⁻¹, CI of low-stem orchards is 12.25 t C ha⁻¹. For tree nurseries no stand densities are available. The weighted mean¹⁸ carbon stock of this combination category is 3.74 t C ha⁻¹.

¹⁸ Weighted by the area of orchards and vineyards

Orchards (CC 35)

Orchards are loosely planted larger fruit trees ('Hochstammobst') with grass understorey. Swiss values for the biomass stock of orchards were applied (FOEN 2011). The total biomass stock of this combination category (including the biomass of the grassland) is assumed to be 24.63 t C ha⁻¹.

Stony Grassland (CC 36)

Stony grassland is categorized as unmanaged grassland. Swiss values for carbon stock of stony grassland were applied (FOEN 2009). The carbon content is assumed to be 4.06 t C ha⁻¹.

Unproductive Grassland (CC 37)

Unproductive grassland is categorized as unmanaged grassland. The category includes grass and herbaceous plants at watersides of lakes and rivers including dams and other flood protection structures, constructions to protect against avalanches and rock slides, and alpine infrastructure. These areas are not used as grassland and are therefore categorised as unmanaged land.

The simple mean value for all altitude classes of grassland of 6.05 t C ha⁻¹ is applied, as for none of these land-use types, biomass data are currently available (FOEN 2009).

b) Carbon in Soils

Permanent Grassland (CC 31)

Carbon stocks in grassland soil refer to a depth of 0-30 cm.

Swiss values for carbon stocks in mineral and organic soils are applied (FOEN 2009). They are based on Leifeld et al. (2003) and Leifeld et al. (2005).

The mean carbon stock values for mineral soils are displayed in Table 7-27

Table 7-27 Mean carbon stocks under permanent grassland on mineral soils, ± represents the standard deviation.

Altitude [m]	C _s [t C ha ⁻¹ , 0-30 cm]
≤ 600	62.02 ± 13
601-1200	67.50 ± 12
>1200	75.18 ± 9
<i>Simple mean carbon stock value over altitude classes</i>	68.23

The mean soil organic carbon stock (0-30 cm) for organic soils is 240 ± 48 t C ha⁻¹.

Shrub Vegetation (CC 32)

Due to lack of data, the Swiss mean value of carbon stocks under permanent grassland on mineral soils (CC 31) of 68.23 t ha⁻¹ was used as the soil carbon default for this category (see Table 7-27) (FOEN 2009).

Vineyards, Low-stem Orchards and Tree Nurseries (CC 33)

Swiss soil carbon values for cropland were applied as it is supposed that these land-use types don't have grass undercover. These soil carbon values are 53.40 t C ha⁻¹ for mineral soils and 240 t C ha⁻¹ for organic soils (FOEN 2009).

Copse (CC 34)

Due to lack of data, the Swiss mean value of carbon stocks under permanent grassland on mineral soils (CC 31) of 68.23 t C ha⁻¹ was used as the soil carbon default for this category (see Table 7-27) (FOEN 2009).

Orchards (CC 35)

Swiss soil carbon values for grassland from the two lower altitude zones (≤ 1200 m) were taken as no specific orchard values were available. These are 64.76 t C ha⁻¹ for mineral soils and 240 t C ha⁻¹ for organic soils (FOEN 2009).

Stony Grassland (CC 36)

Swiss values for soil organic carbon under stony grassland were applied. These grasslands are mainly located at altitudes > 1200 m a.s.l. A carbon stock C_s of 26.31 t C ha⁻¹ is assumed for this combination category (FOEN 2009).

Unproductive Grassland (CC 37)

The category CC 37 'unproductive grasslands' includes grass and herbaceous plants at watersides of lakes and rivers including dams and other flood protection structures, constructions to protect against avalanches and rock slides, and alpine infrastructure.

Swiss mean value of carbon stocks under permanent grassland on mineral soils of 68.23 t C ha⁻¹ is applied (see Table 7-27), as for none of these land-use types, carbon soil data are currently available (FOEN 2009).

c) Changes in carbon stocks

Changes in carbon stock in organic soils are due to a loss of 9.52 t C/ha/y for grassland remaining grassland.

Carbon stock changes in soil for grassland due to changes from mineral to organic soil. are not estimated in Liechtenstein since data on mineral and organic soils is only available for one year. Changes can therefore not be estimated.

7.5.2.2 Land converted to Grassland (5C2)

The activity data collection follows the methods described in chapter 7.2.2..

The carbon stocks in living biomass and in soil are reported in detail under "Grassland remaining grassland" and are summarized as follows:

Table 7-28 Summary table of carbon stocks in grassland (CC 31-37)

Combination category	Carbon in living biomass	Carbon in soils	
		Mineral soils	Organic soils
Permanent grassland (CC 31)	4.45-7.45 t C ha ⁻¹	62.02-75.18 t C ha ⁻¹	240 t C ha ⁻¹
Shrub vegetation (CC 32)	11.6 t C ha ⁻¹	68.23 t C ha ⁻¹	
Vineyards, low-stem Orchards and Tree Nurseries (CC 33)	3.74 t C ha ⁻¹	53.4 t C ha ⁻¹	240 t C ha ⁻¹
Copse (CC 34)	11.6 t C ha ⁻¹	68.23 t C ha ⁻¹	
Orchards (CC 35)	24.63 t C ha ⁻¹	64.76 t C ha ⁻¹	240 t C ha ⁻¹
Stony Grassland (CC 36)	4.06 t C ha ⁻¹	26.31 t C ha ⁻¹	
Unproductive Grassland (CC 37)	6.05 t C ha ⁻¹	68.23 t C ha ⁻¹	

7.5.3 Uncertainties and Time-Series Consistency

The uncertainty for the Key Category 5C2 is 20% for AD. For the EF (CO₂) it is 50% according to the Swiss National Inventory Report (FOEN 2011), see also chapter 1.7 for uncertainty evaluation.

The relative uncertainty in yield determination has been estimated at 13% for biomass carbon from agricultural land (Leifeld et. al. 2005). Data on biomass yields for different elevations and management intensities as published by FAL/RAC (2001) are based on many agricultural field experiments and have a high reliability.

The time-series are consistent.

7.5.4 Source-Specific QA/QC and Verification

The source-specific QA/QC activities have been carried out as mentioned in sections 1.6.1.4 and 1.6.1.5 including also the triple check of the CRF tables (detailed comparison of latest with previous data for the base year, for 2010 and for the changing rates 2010/2011).

The LULUCF expert, the NIC and the NIR author report their QC activities in a checklist (see Annex 8). No additional source-specific QA/QC activities have been carried out.

7.5.5 Source-Specific Recalculations

All data 1990-2011 have been recalculated as follows:

The area in 5C2 is now cumulated during 20 years (instead of 1 year). As a consequence, the areas are larger in 5C2 and smaller in 5C1 than before.

In the CRF tables, the areas and the emissions from organic soils are now reported separately. In former submissions, mineral and organic soils were reported only on an aggregated level.

7.5.6 Source-Specific Planned Improvements

No further source-specific improvements are planned.

7.6 Source Category 5D – Wetlands

7.6.1 Source Category Description

2.3% of the total surface of Liechtenstein are wetlands. Land-use changes from and to wetlands are not very common and occur mainly from forest land to wetlands (e.g. in case of rivers with flood water). Wetlands consist of surface waters (CC 41) and unproductive wet areas such as shore vegetation and fens (CC 42) (Table 7-3). Both types of wetland are categorized as unmanaged.

7.6.2 Methodological Issues

Source categories 5D1 “Wetlands remaining Wetlands” and 5D2 “Land converted to Wetlands” are not key sources.

7.6.2.1 Wetlands remaining Wetlands (5D1)

The activity data collection follows the methods described in chapter 7.2.2. Carbon stocks are taken from Switzerland. Details are described in the following paragraphs.

a) Carbon in Living Biomass

Surface Waters (CC 41)

Surface waters have no carbon stocks by definition.

Unproductive Wetland (CC 42)

Swiss carbon contents for unproductive wetlands are applied (FOEN 2007). The combination category was stratified according to different tags (e.g. tree group on wetland, biotope, linear tree group on wetland, clear-cut on wetland) and each tag was assigned to a carbon content of a known combination category (e.g. tree group on wetland was assigned to the category unproductive forest). Using the percentages (according to occurrence) and the assigned carbon stock values, a weighted average for this combination category was calculated. This calculation led to an average carbon stock of 7.96 t C ha^{-1} .

b) Carbon in Soils

Land cover in CC 42 includes peatlands and reed. Swiss soil carbon stock values are applied (FOEN 2007). Since only data on peatlands are available (240 t C ha^{-1} as for organic soils), it is suggested that the soil carbon stock of unproductive wetlands is the arithmetic mean of grassland on mineral soils ($68.23 \text{ t C ha}^{-1}$) and organic soils (240 t C ha^{-1}), thus 154 t C ha^{-1} .

c) N₂O emissions from drainage of soils

Drainage of intact wetlands is very unlikely. Therefore, no N₂O emissions are reported in CRF Table 5 (II).

7.6.2.2 Land converted to Wetlands (5D2)

The activity data collection follows the methods described in chapter 7.2.2.. In the case of land-use change, the net changes in biomass and soil of both surface waters (CC 41) and unproductive wetland (CC 42) are calculated as described in chapter 7.2.1.

7.6.3 Uncertainties and Time-Series Consistency

The uncertainties for 5D1 and 5D2 are 25% for AD. For the EF (CO₂) it is 50% according to the Swiss National Inventory Report (FOEN 2011), see also chapter 1.7 for uncertainty evaluation.

The time series are consistent.

7.6.4 Source-Specific QA/QC and Verification

The source-specific QA/QC activities have been carried out as mentioned in sections 1.6.1.4 and 1.6.1.5 including also the triple check of the CRF tables (detailed comparison of latest with previous data for the base year, for 2010 and for the changing rates 2010/2011).

The LULUCF expert, the NIC and the NIR author report their QC activities in a checklist (see Annex 8). No additional source-specific QA/QC activities have been carried out.

7.6.5 Source-Specific Recalculations

All data 1990-2011 have been recalculated as follows:

The area in 5D2 is now cumulated during 20 years (instead of 1 year). As a consequence, the areas are larger in 5D2 and smaller in 5D1 than before.

7.6.6 Source-Specific Planned Improvements

No source-specific improvements are planned.

7.7 Source Category 5E – Settlements

7.7.1 Source Category Description

Key source 5E2

Emissions from 5E2 “Land converted to Settlements” is a key source by level. Source category 5E1 “Settlements remaining Settlements” is not a key source.

10.8% of Liechtenstein’s total surface are settlements. Between 1990 and 2011, 379 hectares were converted to settlements, which is an increase of 27.7%. Settlements consist of buildings/constructions (CC 51), herbaceous biomass in settlements (CC 52), shrubs in settlements (CC 53) and trees in settlements (CC 54) as shown in Table 7-3.

7.7.2 Methodological Issues

7.7.2.1 Settlements remaining Settlements (5E1)

The activity data collection follows the methods described in chapter 7.2.2. Carbon stocks are taken from Switzerland. As structure and density of Liechtenstein’s settlements are very similar to the settlements in Switzerland, there is no need to collect Liechtenstein specific

data on trees in settlements and the Swiss data for CC52, 53 and 54 can be used as they are sufficiently accurate. Details are described in the following paragraphs.

a) Carbon in Living Biomass

Buildings and Constructions (CC 51)

Buildings/constructions contain no carbon by default.

Herbaceous Biomass, Shrubs and Trees in Settlements (CC 52, 53, 54)

Swiss values for carbon stocks of herbaceous biomass, shrubs and trees in settlements are applied (FOEN 2007). The calculation of carbon stock is based on the average crown cover area based annual growth rate (IPCC default value, IPCC 2003; p. 3.297), the percentage of vegetation coverage for the respective combination category (herbaceous biomass or shrubs in settlements) and the estimated average age of trees in settlements (20 years). The combination category "Herbaceous Biomass in Settlement" (CC 52) is estimated to contain an average carbon stock of 5.8 t C ha⁻¹, and the combination category "Shrubs in Settlements" (CC 53) a carbon stock of 4.8 t C ha⁻¹. Due to a lack of data, the carbon content of the combination category "Trees in Settlements" (CC 54) was also used for CC 54 (4.8 t C ha⁻¹).

b) Carbon in Soils

Swiss values for soil carbon in settlements are applied (FOEN 2011).

The carbon stock in soil for the combination category "Buildings and Construction" (CC 51) was set to zero. However, a weighting factor of 0.5 (Leifeld et. al. 2003) was applied to soil carbon changes due to land-use changes involving CC 51 (see Chapter 7.2.1). The reason for this is that in general the soil organic matter on construction sites is stored temporarily and later used for replanting the surroundings or it is used to vegetate dumps for example. The oxidative carbon loss due to the disturbance of the soil structure may reach 50%.

The carbon stock in soil for CC 52, 53 and 54 is 53.40 t C ha⁻¹ (0-30 cm, same value as for cropland).

7.7.2.2 Land converted to Settlements (5E2)

The activity data collection follows the methods described in chapter 7.2.2. Carbon factors are reported as described in chapter 7.2.5 for "Settlements remaining Settlements" (CC categories 51-54).

7.7.3 Uncertainties and Time-Series Consistency

The uncertainties for 5E1 and 5E2 are 20% for AD. For the EF (CO₂) it is 50% according to the Swiss National Inventory Report (FOEN 2011), see also chapter 1.7 for uncertainty evaluation.

The time series are consistent.

7.7.4 Source-Specific QA/QC and Verification

The source-specific QA/QC activities have been carried out as mentioned in sections 1.6.1.4 and 1.6.1.5 including also the triple check of the CRF tables (detailed comparison of latest with previous data for the base year, for 2010 and for the changing rates 2010/2011).

The LULUCF expert, the NIC and the NIR author report their QC activities in a checklist (see Annex 8). No additional source-specific QA/QC activities have been carried out.

7.7.5 Source-Specific Recalculations

All data 1990-2011 have been recalculated as follows:

The area in 5E2 is now cumulated during 20 years (instead of 1 year). As a consequence, the areas are larger in 5E2 and smaller in 5E1 than before.

7.7.6 Source-Specific Planned Improvements

No source-specific improvements are planned.

7.8 Source Category 5F – Other Land

7.8.1 Source Category Description

Source category 5F1 “Other Land remaining Other Land” is not a key source. Source category 5F2 “Land converted to Other Land” is a key source by trend.

6.4% of Liechtenstein’s total surface are summarized in “Other Land”. Between 1990 and 2011 the area of “Other Land” has remained rather stable (-0.5%). As shown in Table 7-3 other land (CC 61) covers non-vegetated areas such as glaciers, rocks and shores.

7.8.2 Methodological Issues

By definition, other land has no carbon stocks. In the case of land-use change, the net changes in biomass and soil are calculated as described in chapter 7.2.1.

7.8.3 Uncertainties and Time-Series Consistency

The uncertainties for 5F are 20% for the Activity Data. For the EF (CO₂) it is 50% according to the Swiss National Inventory Report (FOEN 2011), see also chapter 1.7 for uncertainty evaluation.

The time series are consistent

7.8.4 Source-Specific QA/QC and Verification

The source-specific QA/QC activities have been carried out as mentioned in sections 1.6.1.4 and 1.6.1.5 including also the triple check of the CRF tables (detailed comparison of latest with previous data for the base year, for 2010 and for the changing rates 2010/2011).

The LULUCF expert, the NIC and the NIR author report their QC activities in a checklist (see Annex 8). No additional source-specific QA/QC activities have been carried out.

7.8.5 Source-Specific Recalculations

All data 1990-2011 have been recalculated as follows:

The area in 5F2 is now cumulated during 20 years (instead of 1 year). As a consequence, the areas are larger in 5F2 and smaller in 5F1 than before.

7.8.6 Source-Specific Planned Improvements

No source-specific improvements are planned.

8 Waste

8.1 Overview GHG Emissions

Within the waste sector emissions from four source categories are considered:

- 6A “Solid Waste Disposal on Land”
- 6B “Wastewater Handling”
- 6C “Waste Incineration”
- 6D “Others”.

Figure 8-1 depicts Liechtenstein’s greenhouse gas emissions in the waste sector between 1990 and 2011 according to the four source categories 6A-D. Additionally Table 8-1 lists the GHG emissions of this sector by gas in CO₂ equivalent (Gg) for the years 1990 - 2011.

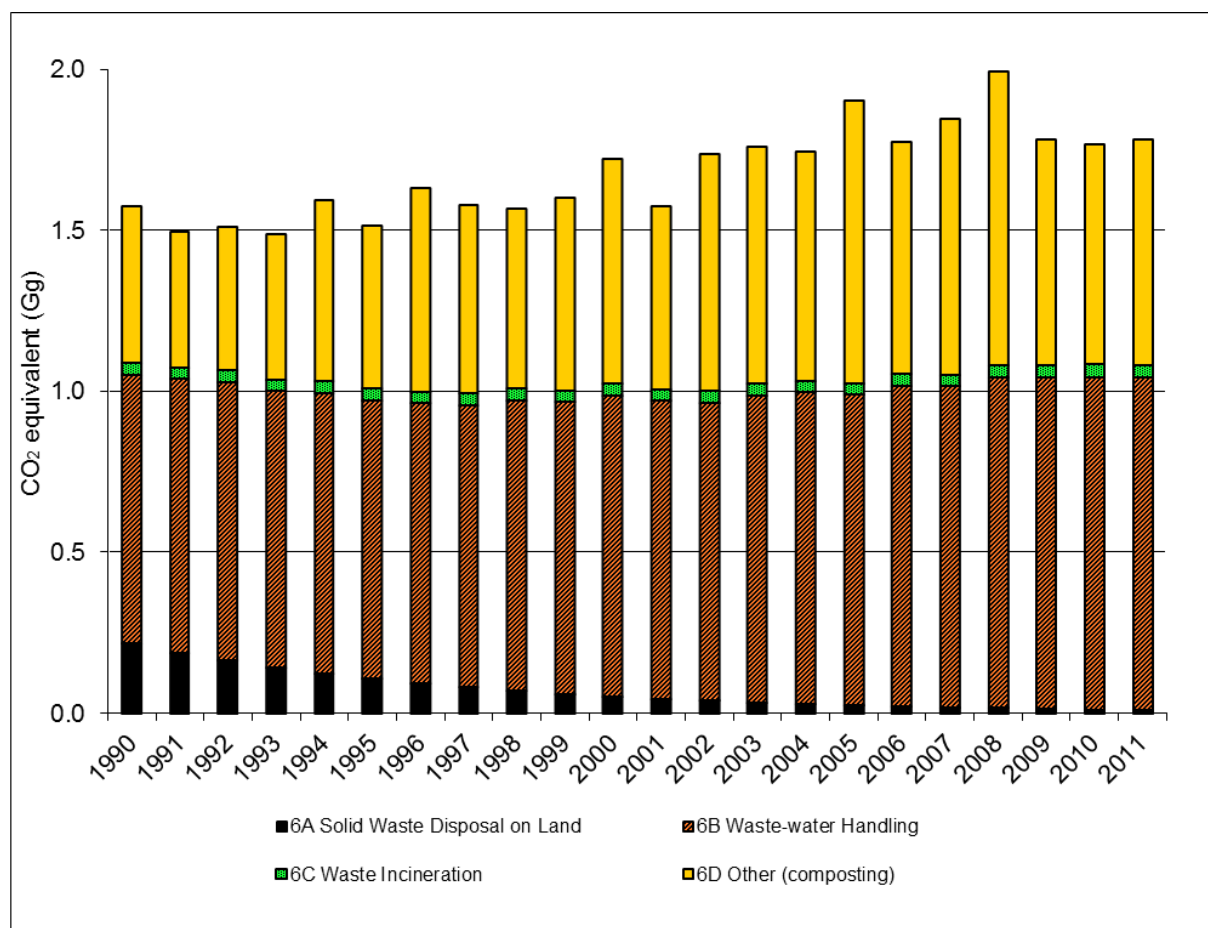

Figure 8-1 Liechtenstein’s greenhouse gas emissions in the waste sector 1990 - 2011.

Table 8-1 GHG emissions of source category 6 Waste by gas in CO₂ equivalent (Gg), 1990 - 2011.

Gas	1990	1991	1992	1993	1994	1995	1996	1997	1998	1999
CO ₂ equivalent (Gg)										
CO ₂	0.03	0.03	0.03	0.03	0.03	0.03	0.03	0.03	0.03	0.03
CH ₄	0.67	0.59	0.59	0.57	0.65	0.58	0.68	0.62	0.60	0.63
N ₂ O	0.87	0.87	0.89	0.89	0.91	0.90	0.93	0.92	0.94	0.95
Sum	1.58	1.50	1.51	1.49	1.60	1.52	1.63	1.58	1.57	1.61

Gas	2000	2001	2002	2003	2004	2005	2006	2007	2008	2009
CO ₂ equivalent (Gg)										
CO ₂	0.03	0.03	0.03	0.03	0.03	0.03	0.03	0.03	0.03	0.03
CH ₄	0.70	0.59	0.72	0.71	0.69	0.82	0.69	0.76	0.85	0.67
N ₂ O	0.99	0.96	0.99	1.02	1.03	1.05	1.05	1.06	1.11	1.08
Sum	1.72	1.58	1.74	1.76	1.75	1.91	1.78	1.85	2.00	1.78

Gas	2010	2011	1990-2011
	CO ₂ eq (Gg)	CO ₂ eq (Gg)	%
CO ₂	0.03	0.03	9.1
CH ₄	0.65	0.66	-1.6
N ₂ O	1.09	1.09	24.7
Sum	1.77	1.78	13.16

In the waste sector a total of 1.78 Gg CO₂ equivalents of greenhouse gases were emitted in 2011. 0.7% of the total emissions stem from 6A "Solid Waste Disposal on Land", 57.9% from 6B "Wastewater Treatment", 2.2% from 6C "Waste Incineration" and 39.2% from the source category 6D "Others" (composting).

The total greenhouse gas emissions show an increase from 1990 until 2011 by +13%.

8.2 Source Category 6A – Solid Waste Disposal on Land

8.2.1 Source Category Description

Source category 6A "Solid Waste Disposal on Land" is **not a key category**.

The source category 6A "Solid Waste Disposal on Land" comprises all emissions from handling of solid waste on landfill sites.

There are no managed waste disposal sites reported in Liechtenstein. Therefore emissions from the source category 6A1 "Managed Waste Disposal Sites" are not occurring.

Liechtenstein has historic unmanaged landfills. During the 1960ies, Liechtenstein stopped disposing of municipal solid waste on landfill sites and instead exported it for incineration to Switzerland. This transition was concluded in 1974, when the last municipality in the country stopped land-filling.

The landfills in Liechtenstein were unmanaged (in the definition of IPCC GPG), because municipal solid waste (MSW) was disposed off on the landfills by users directly (only on 3 of over 30 landfill sites a temporary control by landfill staff was executed). No mechanical compacting or levelling of waste has been carried out. No collection or treatment of leachate took place which caused environmental pollution¹⁹. Landfills are all less than 5m deep²⁰.

¹⁹ Source: E-mail Helmut Kindle/OEP of June 24, 2007.

No landfill gas was collected for flaring or energy recovery.

Category 6A3 "Others" does not occur in Liechtenstein. Therefore, all emissions from landfills are reported under category 6A2 "Unmanaged Waste Disposal Sites".

Table 8-2 Specification of source category 6A "Solid Waste Disposal on Land".

6A1	Managed Waste Disposal on Land	Not occurring in Liechtenstein	-
6A2	Unmanaged Waste Disposal Sites	Emissions from handling of solid waste on unmanaged landfill sites	EF: FOEN 2012 AD: OEP 2007c
6A3	Others	Not occurring in Liechtenstein	-

8.2.2 Methodological Issues

8.2.2.1 Solid Waste Disposal on Unmanaged Waste Disposal Sites (6A2)

8.2.2.2 Methodology

A Tier 2 approach is chosen. The rate of CH₄ generation over time is based on the First Order Decay model (FOD) according to IPCC (IPCC 1997a-c). The following equation is applied to calculate the CH₄ generation in the year t:

$$\text{CH}_4 \text{ generated in the year } t \text{ [Gg/year]} = \sum_x [A \cdot k \cdot M(x) \cdot L_0(x) \cdot e^{-k(t-x)}] \cdot (1-OX)$$

where

t =	current year
x =	the year of waste input, $x \leq t$
A =	$(1-k)/k$, norm factor (fraction)
k =	methane generation rate [1/yr]
M(x) =	the amount of waste disposed in year x
L ₀ (x) =	methane generation potential ($MCF(x) \cdot DOC(x) \cdot DOC_F \cdot F \cdot 16/12$) [Gg CH ₄ / Gg waste]
MCF(x) =	methane correction factor (fraction)
DOC(x) =	degradable organic carbon [Gg C/ Gg waste]
DOC _F =	fraction of DOC, that is converted to landfill gas (fraction)
F =	fraction of CH ₄ in landfill gas (fraction)
16/12 =	factor to convert C to CH ₄ .
OX =	oxidation factor (fraction)

The following general assumptions are made:

$MCF(x) = 0.4$ = constant for all years (default value according to IPCC for unmanaged solid waste disposal sites of less than 5 m depth)

$OX = 0$ (default value according to IPCC 1997a-c)

$DOC_F = 0.6$ (default value according to IPCC 1997a-c)

$F = 0.5$ (default value according to IPCC 1997a-c)

The degradable organic carbon (DOC) is calculated based on the default values from IPCC 1997a-c and based on country specific data on waste composition for MSW in Switzerland

²⁰ Source: Email Helmut Kindle/OEP of June 12, 2007, based on research in internal files on old landfills of OEP.

for 1993 (source EMIS 2012 1A1a & 6A1 Kehrichtdeponien). It is assumed that the Swiss MSW composition is representative for the situation in Liechtenstein.

Table 8-3 Calculation of DOC for Liechtenstein (Source DOC: IPCC 1997a-c, source waste fractions: EMIS 2012/1A1a & 6A1, Quantities of 1993)

	Waste Fraction	DOC
Paper and Textile and Cardboard %	28	0.4
Garden waste and non-food organic putrescible %	5	0.17
Food waste %	22	0.15
Wood and Straw %	0	0.3
Other materials (glass, metals plastic, minerals, etc.with no contributions to methan generation) %	45	0
Resulting DOC		0.154

For the calculation of CH₄ generation from unmanaged landfilling of MSW the k factor is based on FOEN 2012 (Table 8-4). The Swiss NIR assumes a half-life of 5 years, for which k = 0.139 y⁻¹ results.

8.2.2.3 Emission Factors

The emissions are directly calculated in the FOD-model as described above and no country specific emission factor was used.

8.2.2.4 Activity data

Activity data for unmanaged MSW Disposal on Land (6A2) have been estimated by OEP (OEP 2007c). The estimates are based on internal (unpublished) research done at OEP from 1985 - 1990 that analysed the development of waste quantities in the last century for the elaboration of a national waste strategy.

Based on this work, the following MSW quantities are assumed to have been landfilled from 1930 until the closure of the last landfill in 1974:

Table 8-4 Amount of MSW landfilled in Liechtenstein (OEP 2007c)

Year	MSW/cap [kg/a]	Inhabitants (average)	MSW [t/a]
1930-39	150	10500	1575
1940-49	100	12300	1230
1950-59	200	15200	3040
1960-69	300	18500	5550
1970-75	MSW declines linearly to 0		

Because the transition from landfilling in the country to exporting MSW to Switzerland for incineration took place gradually, it is assumed that the amount of MSW landfilled declines linearly after 1970 to zero tons in 1975.

8.2.2.5 Emissions

The following Table 8-5 provides the results of the emission calculation based on the FOD-modeling as well as the waste quantities that have been annually disposed of.

Table 8-5 CH₄ emissions from MSW landfilled in Liechtenstein 1930 – 2012 (Result of FOD model calculation)

Year	Annual Deposition Tons/Year	Emissions t CH ₄	Emissions t CO ₂ eq	Year	Annual Deposition Tons/Year	Emissions t CH ₄	Emissions t CO ₂ eq
1930	1575	5.0	105.4	1970	5550	120.5	2531.1
1931	1575	9.4	197.2	1971	4440	119.0	2499.8
1932	1575	13.2	277.0	1972	3330	114.2	2398.3
1933	1575	16.5	346.5	1973	2220	106.5	2235.7
1934	1575	19.4	406.9	1974	1110	96.2	2019.8
1935	1575	21.9	459.5	1975	0	83.7	1757.7
1936	1575	24.1	505.3	1976	0	72.8	1529.6
1937	1575	26.0	545.1	1977	0	63.4	1331.1
1938	1575	27.6	579.8	1978	0	55.2	1158.4
1939	1575	29.0	610.0	1979	0	48.0	1008.0
1940	1230	29.2	613.2	1980	0	41.8	877.2
1941	1230	29.3	615.9	1981	0	36.4	763.4
1942	1230	29.4	618.3	1982	0	31.6	664.3
1943	1230	29.5	620.4	1983	0	27.5	578.1
1944	1230	29.6	622.2	1984	0	24.0	503.1
1945	1230	29.7	623.8	1985	0	20.8	437.8
1946	1230	29.8	625.2	1986	0	18.1	381.0
1947	1230	29.8	626.4	1987	0	15.8	331.5
1948	1230	29.9	627.4	1988	0	13.7	288.5
1949	1230	29.9	628.3	1989	0	12.0	251.1
1950	3040	35.7	750.2	1990	0	10.4	218.5
1951	3040	40.8	856.4	1991	0	9.1	190.1
1952	3040	45.2	948.7	1992	0	7.9	165.5
1953	3040	49.0	1029.1	1993	0	6.9	144.0
1954	3040	52.3	1099.0	1994	0	6.0	125.3
1955	3040	55.2	1159.8	1995	0	5.2	109.0
1956	3040	57.8	1212.8	1996	0	4.5	94.9
1957	3040	59.9	1258.9	1997	0	3.9	82.6
1958	3040	61.9	1299.0	1998	0	3.4	71.9
1959	3040	63.5	1333.9	1999	0	3.0	62.5
1960	5550	73.0	1532.2	2000	0	2.6	54.4
1961	5550	81.2	1704.9	2001	0	2.3	47.4
1962	5550	88.3	1855.1	2002	0	2.0	41.2
1963	5550	94.6	1985.8	2003	0	1.7	35.9
1964	5550	100.0	2099.6	2004	0	1.5	31.2
1965	5550	104.7	2198.6	2005	0	1.3	27.2
1966	5550	108.8	2284.7	2006	0	1.1	23.6
1967	5550	112.4	2359.7	2007	0	1.0	20.6
1968	5550	115.5	2425.0	2008	0	0.9	17.9
1969	5550	118.2	2481.7	2009	0	0.7	15.6
				2010	0	0.6	13.6
				2011	0	0.6	11.8
				2012	0	0.5	10.3

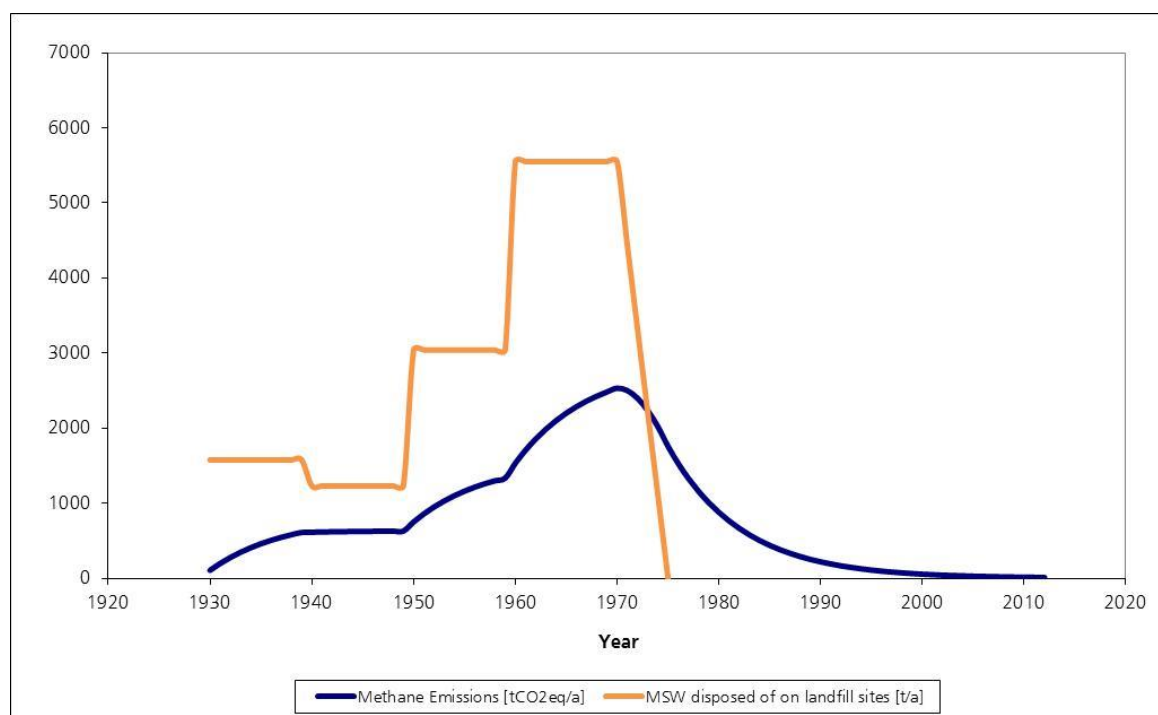

Figure 8-2 MSW disposed of on landfill sites and corresponding emissions of CH₄ in Gg CO₂ equivalents.

8.2.3 Uncertainties and Time-Series Consistency

A preliminary uncertainty assessment based on expert judgment results in low confidence in emission estimates.

The time series is consistent.

8.2.4 Source-Specific QA/QC and Verification

The source-specific QA/QC activities have been carried out as mentioned in sections 1.6.1.4 and 1.6.1.5 including also the triple check of the CRF tables (detailed comparison of latest with previous data for the base year, for 2010 and for the changing rates 2010/2011).

8.2.5 Source-Specific Recalculations

No recalculations have been carried out.

8.2.6 Source-Specific Planned Improvements

No source-specific improvements are planned.

8.3 Source Category 6B – Wastewater Handling

8.3.1 Source Category Description

Source category 6B “Wastewater Handling” is **not a key source**.

Source category 6B1 "Industrial Waste Water" comprises all emissions from the handling of liquid wastes and sludge from industrial processes such as food processing and metal processing industry²¹. Emissions from source category 6B1 are included in source category 6B2 "Domestic and Commercial Waste Water". This is motivated by the fact that a higher amount of industrial waste water is pre-treated and not treated on-site, and is then processed in the municipal waste water treatment plants considered under 6B2.

Source category 6B2 "Domestic and Commercial Waste Water" comprises all emissions from handling of liquid wastes and sludge from housing and commercial sources (including gray water and night soil).

Table 8-6 Specification of source category 6B "Wastewater Handling".

6B	Source	Specification	Data Source
6B1	Industrial Waste Water	Emissions from handling of liquid wastes and sludge from industrial processes (included in 6B2)	-
6B2	Domestic and Commercial Waste Water	Emissions from handling of liquid wastes and sludge from housing and commercial sources	AD: OEP 2009d (sewage gas production), AZV 2011 (sewage waste quantities) EF: FOEN 2012, IPCC 1997c
6B3	Others	Not occurring in Liechtenstein	-

8.3.2 Methodological Issues

8.3.2.1 Methodology

In Liechtenstein waste water treatment plants are equipped to collect sewage sludge. The sludge is processed in a digester to produce biogas. The biogas is used for co-generation of heat and power on-site.

For CH₄ emissions from domestic and commercial waste water treatment (6B2), a country specific method is used, in line with the method used in the Swiss NIR (FOEN 2012). The CH₄ emissions are calculated by multiplying the amount of biogas produced in the digesters times the emission factor.

N₂O emissions are calculated based on the IPCC default method (IPCC 1997c).

The emissions from the energy generation in the co-generation units itself are reported under 1A1 Energy Industries.

8.3.2.2 Emission Factors

For CH₄ it is assumed that 0.75% of the biogas (volume) is emitted as leakage (SFOE 2002). This value corresponds to the leakage rate used in FOEN 2012 (see EMIS 2012 6B2

²¹ There is one large food producer which pre-treats its effluents that are then further treated in the treatment plant Bendern. It accounts for the major share of industrial waste water. There are however two metal processors which, by now, treat their effluents on-site. As those industrial treatment plants are obsolete, it is planned to conduct a industrial pre-treatment only with a post treatment in Bendern. (According to Egon Hilbe, Amt für Umwelt, LIE, 5.1.2012)

Kommunale Kläranlagen). Based on actual measurements in wastewater treatment plants in Switzerland, a methane content of the biogas by volume of 65% is assumed. With this a country specific emission factor of $0.0049\text{m}^3 \text{CH}_4$ per m^3 of biogas results.

N_2O is derived based on the IPCC-default method. For this submission, specific numbers for protein consumption were used. Total protein consumption in Switzerland raised from 237 t in 1990 to 256 t N_2O in 2006 (Swiss Farmer's Union 2006). Values are now available for more recent years.. Hence, protein consumption factors range from 34.8 to 32.2 kg/inhabitant and year. We assume that similar conditions prevail in Liechtenstein. According to previous submissions, an N fraction of 0.16 kg N per kg protein (FracNPR; IPCCdefault) was used. Emission factors differ from year to year, and range around 84.9 g N_2O per inhabitant²²,

8.3.2.3 Activity Data

Activity data for CH_4 emissions from Domestic and Commercial Waste Water (6B2) are the total amount of gas resulting from waste water treatment in Liechtenstein. In 1990 three waste water treatment plants had been operational. In 2004, two plants remained, and since 2005 all waste water of the principality is treated in one plant in Bendern.

Table 8-7 Activity data in 6B2 "Domestic and Commercial Waste Water": Amount of waste water treatment gas produced by the three treatment plants in Liechtenstein (OEP 2009d, AZV 2011).

Gas production		1990	1991	1992	1993	1994	1995	1996	1997	1998	1999
Total gas production	m3	675'944	708'444	750'015	749'887	813'691	736'949	786'301	800'429	866'294	932'935
Balzers	m3	44'256	44'785	42'284	46'055	42'709	43'540	48'964	50'090	48'538	49'206
Vaduz	m3	66'024	55'745	58'464	64'464	64'436	57'713	47'703	0	0	0
Bendern	m3	565'664	607'914	649'267	639'368	706'546	635'696	689'634	750'339	817'756	883'729

Gas production		2000	2001	2002	2003	2004	2005	2006	2007	2008	2009
Total gas production	m3	941'707	905'828	868'172	899'829	939'399	903'804	978'237	1'053'052	1'086'338	1'026'834
Balzers	m3	54'321	53'834	51'144	45'723	5'715	0	0	0	0	0
Vaduz	m3	0	0	0	0	0	0	0	0	0	0
Bendern	m3	887'386	851'994	817'028	854'106	933'684	903'804	978'237	1'053'052	1'086'338	1'026'834

Gas production		2010	2011
Total gas production	m3	965'254	976'295
Balzers	m3	0	0
Vaduz	m3	0	0
Bendern	m3	965'254	976'295

Activity data for N_2O emissions from Domestic and Commercial Waste Water (6B2) are the number of inhabitants (total, i.e. connected and non-connected) in Liechtenstein (provided in Section 4.2.2).

8.3.3 Uncertainties and Time-Series Consistency

A preliminary uncertainty assessment based on expert judgment results in low confidence in emission estimates.

The time series is consistent.

²² Calculation: $33.86 * 0.16 * 0.01 * 44/28$ (According to the molecular weight of N_2O) = 0.0851 kg N_2O per inhabitant.

8.3.4 Source-Specific QA/QC and Verification

The source-specific QA/QC activities have been carried out as mentioned in sections 1.6.1.4 and 1.6.1.5 including also the triple check of the CRF tables (detailed comparison of latest with previous data for the base year, for 2010 and for the changing rates 2010/2011).

8.3.5 Source-Specific Recalculations

Recalculations on CH₄ emissions have been done on the whole time series as the calculations, by mistake, were made on the density of waste water treatment gas (0.66 kg/m³) instead of the density of methane (1.03 kg/m³).

Recalculations on N₂O emissions have been done for the years 2007-2010 as the protein consumption as a mistake had been calculated with a constant intake for those years.

8.3.6 Source-Specific Planned Improvements

No source-specific improvements are planned.

Regarding numbers for protein consumption, values for more recent years are available (Swiss Farmer's Union). In future submissions is planned to use year specific values for 2007 - 2009 as well.

8.4 Source Category 6C – Waste Incineration

8.4.1 Source Category Description

Source category 6C "Waste Incineration" is **not a key source**.

There are no waste incineration plants in Liechtenstein. Since the beginning of 1975 all municipal solid waste from Liechtenstein is exported to Switzerland for incineration.

Therefore, source category 6C includes only emissions from the illegal incineration of gardening and household wastes, and of wastes on construction sites open burning.

8.4.2 Methodological Issues

8.4.2.1 Methodology

For the calculation of the greenhouse gas emissions from illegal incineration of wastes a country specific Tier 2 method is used, based on CORINAIR, adapted from the Swiss NIR (FOEN 2012).

GHG emissions are calculated by multiplying the estimated amount of illegally incinerated waste by emission factors.

8.4.2.2 Emission Factors

It is assumed that the waste mix in illegal waste incineration is the same as the one for municipal solid waste incineration in Switzerland (FOEN 2012), i.e. 40% of the waste mix is of fossil origin. The main source of fossil CO₂ emissions are plastics.

Country specific emission factors for CO₂, N₂O and CH₄ are adopted from the Swiss NIR (FOEN 2012). The following table presents the emission factors used in source category 6C:

Table 8-8 Emission Factors for 6C "Waste Incineration" (FOEN 2012).

6C Waste Incineration				
Source	CO₂ biogen kg/t	CO₂ fossil kg/t	CH₄ kg/t	N₂O kg/t
Illegal waste incineration	706	510	6	0.15

8.4.2.3 Activity Data

The activity data for Waste Incineration are the quantities of waste incinerated illegally. This amount is calculated from the total amount of municipal solid waste generated in Liechtenstein by assuming that waste incinerated illegally represents 0.5% of waste generated²³ (OS 2012c, OEP 2009c).

Table 8-9 Activity data for source category 6C "Waste Incineration". Source of amount of municipal solid waste (MSW) generated OS 2012c, OEP 2009c.

		1990	1991	1992	1993	1994	1995	1996	1997	1998	1999
MSW generated	t/a	8'000	8'020	8'040	8'060	8'080	8'100	8'120	8'140	8'160	8'180
Fraction incinerated illegally		0.5%	0.5%	0.5%	0.5%	0.5%	0.5%	0.5%	0.5%	0.5%	0.5%
Waste incinerated illegally	t/a	40.0	40.1	40.2	40.3	40.4	40.5	40.6	40.7	40.8	40.9

		2000	2001	2002	2003	2004	2005	2006	2007	2008	2009
MSW generated	t/a	8'200	8'220	8'240	8'260	8'280	8'038	8'267	8'338	8'460	8'560
Fraction incinerated illegally		0.5%	0.5%	0.5%	0.5%	0.5%	0.5%	0.5%	0.5%	0.5%	0.5%
Waste incinerated illegally	t/a	41.0	41.1	41.2	41.3	41.4	40.2	41.3	41.7	42.3	42.8

		2010	2011
MSW generated	t/a	8'662	8'728
Fraction incinerated illegally		0.5%	0.5%
Waste incinerated illegally	t/a	43.3	43.6

8.4.3 Uncertainties and Time-Series Consistency

A preliminary uncertainty assessment based on expert judgment results in low confidence in emissions estimates.

The time series is consistent.

8.4.4 Source-Specific QA/QC and Verification

The source-specific QA/QC activities have been carried out as mentioned in sections 1.6.1.4 and 1.6.1.5 including also the triple check of the CRF tables (detailed comparison of latest with previous data for the base year, for 2010 and for the changing rates 2010/2011).

²³ This assumption is based on a Swiss study that showed that illegal incineration in private gardens and stoves are of the order of magnitude of 1% of total MSW generation. Assuming that no illegal incineration in gardens takes place in Liechtenstein, a value of 0.5% for illegal incineration in stoves is estimated.

8.4.5 Source-Specific Recalculations

Recalculations for fossile and biogen CO₂ emissions have been done for the whole time series. The reason was a misinterpretation of the emission data from the Swiss NIR (FOEN 2012) which serves as basis for the emission factors for Liechtenstein for illegal waste incineration. The recalculations lead to higher CO₂ emissions for waste incineration.

8.4.6 Source-Specific Planned Improvements

No source-specific improvements are planned.

8.5 Source Category 6D – Other

8.5.1 Source Category Description

Source category 6D "Other" is **not a key category**.

Source category 6D "Other" comprises the GHG emissions from composting of organic waste. Composting covers the GHG emissions from larger centralized composting plants as well as from backyard composting.

Emissions from the application of compost to agricultural land are reported under category 4 "Agriculture".

There are no shredding plants in Liechtenstein, therefore emissions from car shredding are not occurring.

Table 8-10 Specification of source category 6D "Other".

6D	Source	Specification	Data Source
	Composting	Emissions from composting of organic waste	AD: OS 2012c, OEP 2009c EF: FOEN 2012

8.5.2 Methodological Issues

8.5.2.1 Methodology

For the CH₄ and N₂O emissions from composting a country specific method is used, based on the Swiss NIR (FOEN 2012). The GHG emissions are calculated by multiplying the quantity of composted wastes by the emission factors. For all years the same constant country specific emission factors have been applied.

N₂O emissions from the product of composting that arise after their application in agriculture are reported under source category 4D4.

8.5.2.2 Emission Factors

Emission factors for composting have been adopted from the Swiss NIR (FOEN 2012): 5 kg CH₄/t of composted waste and 0.07 kg N₂O/t of composted waste. They are based on measurements and expert estimates, documented in the Swiss EMIS database (EMIS 2012/6D)

8.5.2.3 Activity data

The Office of Environmental Protection provides data on the amount of waste treated in centralized compost plants. In order to account for the numerous small compost sites in people's backyards, backyard composting has been estimated by an expert estimate²⁴: it is estimated to amount to 8% in 1990 and 5% in 2005 and following years compared to the waste composted in centralized compost plants (in the years in between, the factor is linearly interpolated). The expert guess has been re-confirmed by OEP (2012a).

Table 8-11 Activity data in 6D "Other".

Waste composting		1990	1991	1992	1993	1994	1995	1996	1997	1998	1999
Composted centrally	t/a	3'567	3'078	3'287	3'311	4'143	3'734	4'686	4'316	4'167	4'460
Additionally in backyard		8.0%	7.8%	7.6%	7.4%	7.2%	7.0%	6.8%	6.6%	6.4%	6.2%
Composted total	t/a	3'852	3'318	3'537	3'556	4'441	3'995	5'005	4'601	4'433	4'737

Waste composting		2000	2001	2002	2003	2004	2005	2006	2007	2008	2009
Composted centrally	t/a	5'210	4'247	5'501	5'508	5'345	6'614	5'442	5'981	6'859	5'258
Additionally in backyard		6.0%	5.8%	5.6%	5.4%	5.2%	5.0%	5.0%	5.0%	5.0%	5.0%
Composted total	t/a	5'522	4'494	5'809	5'806	5'623	6'945	5'714	6'280	7'202	5'521

Waste composting		2010	2011
Composted centrally	t/a	5'154	5'260
Additionally in backyard		5.0%	5.0%
Composted total	t/a	5'411	5'523

In 2008, there was a significant increase of composted waste quantities. The peak can be related to the clearing of a forest area in the community of Eschen for environmental restoration²⁵. Already in 2009, the total amount of composted material falls back to similar levels as previous years. The peak is also the reason for the sudden decrease in CH₄ and N₂O emission in 2009 compared to 2008.

8.5.3 Uncertainties and Time-Series Consistency

A preliminary uncertainty assessment based on expert judgment results in low confidence in emissions estimates.

The time series is consistent.

8.5.4 Source-Specific QA/QC and Verification

The source-specific QA/QC activities have been carried out as mentioned in sections 1.6.1.4 and 1.6.1.5 including also the triple check of the CRF tables (detailed comparison of latest with previous data for the base year, for 2010 and for the changing rates 2010/2011).

²⁴ Source: Andreas Gstoehl, OEP, email to J. Beckbissinger, Acontec, of August 16th, 2006.

²⁵ Source: Hr. Bürzle, AfU, oral communication to J. Beckbissinger, acontec, of November 23, 2010

8.5.5 Source-Specific Recalculations

No source-specific recalculations have been carried out.

8.5.6 Source-Specific Planned Improvements

Composting: Liechtenstein reported CH₄ and N₂O emissions from composting. The amount of composting in small compost sites was estimated as a proportion of the amount of composting in centralized compost plants; this estimate was based on expert judgement. The proportion is 8 per cent in 1990 and 5 per cent in 2005.

9 Other

No other sources or sinks are occurring in Liechtenstein.

9.1.1 Source-Specific Recalculations

The indirect CO₂ emissions due to atmospheric decomposition of NMVOC from source category 3 Solvent and Other Product Use was moved back into chapter 5. For the rationale behind this reallocation see last year's submission (OEP 2012b).

Due to the re-allocation, recalculations have been done on the whole time series.

10 Recalculations

10.1 Explanations and Justifications for Recalculations

The recalculations have been described in the respective subsections of the preceding chapters for all sectors. Furthermore the overview in Chapter 1.3.3 depicts the issues of the review team that have been incorporated into this new submission.

The recalculations are summarised below.

10.1.1 GHG Inventory

1 Energy

1A: For 2010, the difference with respect to Submission 2011 is 0.25 Gg CO₂ eq (+0.12%). This is due to several minor recalculations. This is due to minor recalculations in the source categories 1A3b (Road Transport) and 1A4a-c (Other Sectors: Commercial/Industrial, Residential, Agriculture/Forestry/Fisheries).

1A3b: The N₂O emission factors for diesel and petrol were updated based on the new Swiss emission factors (FOEN 2012), which affects the time series from 1991 to 2009. For 2010, CH₄ and N₂O emission factors were updated based on the Swiss submission (FOEN 2012).

1A4b/1A4c: Based on a first detailed census of alkylate gasoline consumption a more reliable consumption figure for 2011 was available; consequently the time series from 2001 to 2010 was linearly interpolated since otherwise a 44% increase from 2010 to 2011 would have resulted. This affected CO₂, CH₄ and N₂O emissions. Furthermore, the consumption figure for liquid gas for 2010 was corrected by the Office of Statistics from 87 t to 116 t, which affected CO₂, CH₄ and N₂O emissions for 2010.

2 Industrial Processes

2A5/ 2A6/ 2F1: Preliminary data on the Swiss inhabitants for the year 2010 has been adjusted according to the definite data published in SFOE 2012.

3 Solvent and other Product Use

3D: The indirect CO₂ emissions due to atmospheric decomposition of NMVOC from source category 3 Solvent and Other Product Use was moved back from chapter 9 into chapter 5. For the rationale behind this reallocation see last year's submission (OEP 2012b).

Due to the re-allocation, recalculations have been done on the whole time series.

4 Agriculture

In all source categories of the Agriculture sector, recalculations were necessary due to updated activity data. This reflects the fact that statistical data for the current year in a given submission are sometimes not available yet at the time the submission is being produced; only in the following year the updated information is available. This also explains any deviations from official statistics that may arise for the most recent year (in this case 2011).

4A: For 2010, the difference is 0.03 Gg CO₂ eq (+0.27%) compared to the figure for the same year in Submission 2012. It is due to updated data on milk production per head of mature dairy cattle, which had been estimated based on 2009 data for the 2012 submission (since the data for 2010 were not yet available at the time).

4B: There is a difference in 2010 emissions of 0.21% or 0.007 Gg CO₂ eq. with regard to the figure for the same year in Submission 2012. This is due to updated data on milk production

per head of mature dairy cattle, which had been estimated based on 2009 data for the 2012 submission (since the data for 2010 were not yet available at the time). Since energy consumption and thus excretion is estimated based on milk production, emissions from manure management were also affected (compare Chapter 6.2.5).

4D: There is a difference in 2010 emissions of +1.61% or 0.14 Gg CO₂ eq. with regard to the value for the same year in Submission 2011. This is due to updated land use data that was not yet available for Submission 2011.

5 LULUCF

5: A conversion time of 20 years instead of 1 year was applied for all land-use changes (see Chapters 7.X.5). This improvement is a response to FCCC/ARR 2011, §65. For forests, this lead to a lower loss of carbon in living biomass (no harvesting on converted areas of 5A2). For grassland, the carbon loss due to land-use conversions from forest land to grassland 1997-2002 is smoothed and delayed (Figure 7-2).

5B, 5C: The areas and emissions of organic soils in 5B and 5C are now reported separately from mineral soils. This improvement is a response to FCCC/ARR 2011, §68, §70 and §74. Forests (5A) do not occur on organic soils.

5(III): An error in the formula for calculating the N₂O emissions as a result of the disturbance associated with land-use conversion to cropland (CRF Table 5(III)) was corrected. This correction lead to higher emissions.

6 Waste

6B2: Recalculations on CH₄ emissions have been done on the whole time series as the calculations, by mistake, were made on the density of waste water treatment gas (0.66 kg/m³) instead of the density of methane (1.03 kg/m³).

6B2: Recalculations on N₂O emissions have been done for the years 2007-2010 as the protein consumption as a mistake had been calculated with a constant intake for those years..

6C: Recalculations for fossil and biogenic CO₂ emissions have been done for the whole time series. The reason was a misinterpretation of the emission data from the Swiss NIR (FOEN 2012) which serves as basis for the emission factors for Liechtenstein for illegal waste incineration. The recalculations lead to higher CO₂ emissions for waste incineration.

7 Other

The indirect CO₂ emissions due to atmospheric decomposition of NMVOC from source category 3 Solvent and Other Product Use was moved back into chapter 5. For the rational behind this reallocation see last year's submission (OEP 2012b). Due to this re-allocation, recalculations have been done on the whole time series.

10.1.2 KP-LULUCF

A calculation error causing too high areas of afforestation was corrected. This lead to lower carbon sinks under A.1.1 in all years. This correction was already included in the response to the Saturday Paper (FCCC/ARR 2012) in November 2012.

The correction of a calculation error lead to small changes in the area of deforestations (A.2).

10.2 Implications for Emission Levels 1990 and 2010

10.2.1 GHG Inventory

Table 10-1 shows the recalculation results for the base year 1990. The recalculations have the following effect on the emissions in 1990 in comparison with the submitted emissions of the previous year: they difference the national total emissions by -0.315 Gg CO₂ eq (-0.137%) without emissions/removals from LULUCF. Including LULUCF the difference is -1.571 Gg CO₂ eq or -0.706%.

Table 10-1 Overview of implications of recalculations on 1990 data. Emissions are shown before the recalculation according to the previous submission in 2012 "Prev." (OEP 2012b) and after the recalculation according to the present submission "Latest". The differences "Differ." are defined as latest minus previous submission. Where differences appear, cells are highlighted in grey.

Recalculation	CO ₂			CH ₄			N ₂ O			Sum (CO ₂ , CH ₄ and N ₂ O)		
	Prev.	Latest	Differ.	Prev.	Latest	Differ.	Prev.	Latest	Differ.	Prev.	Latest	Differ.
Emissions for 1990												
Source and Sink Categories	CO ₂ equivalent (Gg)									CO ₂ equivalent (Gg)		
1 Energy	201.5	201.5	0.00	1.1	1.1	0.00	1.1	1.1	0.00	203.8	203.8	0.00
2 Ind. Processes (without syn. gases)	NO	NO		NO	NO		NO	NO				
3 Solvent and Other Product Use	0.1	1.5	1.46				0.5	0.5	0.00	0.6	2.0	1.46
4 Agriculture				14.3	12.6	-1.77	10.4	10.4	0.00	24.7	23.0	-1.77
5 LULUCF	-8.2	-9.5	-1.26	NO	NO		NO	0.0		-8.2	-9.5	-1.26
6 Waste	0.0	0.0	0.02	0.7	0.7	-0.03	0.9	0.9	0.00	1.6	1.6	0.00
Sum (without synthetic gases)	193.4	193.6	0.23	16.2	14.4	-1.80	12.9	12.9	0.00	222.4	220.9	-1.57
Recalculation	HFC			PFC			SF₆			Sum (synthetic gases)		
Emissions for 1990	Prev.	Latest	Differ.	Prev.	Latest	Differ.	Prev.	Latest	Differ.	Prev.	Latest	Differ.
Source and Sink Categories	CO ₂ equivalent (Gg)									CO ₂ equivalent (Gg)		
2 Ind. Processes (only syn. gases)	0.00	0.00	0.00	NA,NO	NA,NO		NA,NO	NA,NO		0.0	0.0	0.00
Recalculation										Sum (all gases)		
Emissions for 1990										Prev.	Latest	Differ.
Source and Sink Categories										CO ₂ equivalent (Gg)		
Total CO₂ eq Em. with LULUCF										222.43	220.86	-1.571
										100.00%	99.29%	-0.706%
Total CO₂ eq Em. without LULUCF										230.65	230.33	-0.315
										100.00%	99.86%	-0.137%

For 2010, the recalculations result in a small increase of the total emissions in CO₂ equivalents of 0.950 Gg CO₂ eq (0.407%) without emissions/removals from LULUCF. Including LULUCF the recalculations led to a decrease with a difference of -0.195 Gg CO₂ eq (-0.086%).

Table 10-2 Overview of implications of recalculations on 2010 data. Emissions are shown before the recalculation according to the previous submission in 2012 "Prev." (OEP 2012b) and after the recalculation according to the present submission "Latest". The differences "Differ." are defined as latest minus previous submission. Where differences appear, cells are highlighted in grey.

Recalculation	CO ₂			CH ₄			N ₂ O			Sum (CO ₂ , CH ₄ and N ₂ O)		
	Prev.	Latest	Differ.	Prev.	Latest	Differ.	Prev.	Latest	Differ.	Prev.	Latest	Differ.
Emissions for 2010												
Source and Sink Categories	CO ₂ equivalent (Gg)									CO ₂ equivalent (Gg)		
1 Energy	198.7	198.8	0.11	2.0	2.0	-0.01	0.9	1.1	0.15	201.6	201.9	0.25
2 Ind. Processes (without syn. gases)	NO	NO		NO	NO		NO	NO				
3 Solvent and Other Product Use	0.3	0.7	0.45				0.3	0.3	0.01	0.5	1.0	0.46
4 Agriculture				12.4	12.5	0.03	10.1	10.3	0.14	22.6	22.7	0.18
5 LULUCF	-6.0	-7.2	-1.15	NO	NO		0.0	0.0	0.01	-6.0	-7.1	-1.14
6 Waste	0.01	0.03	0.02	0.7	0.7	-0.04	1.0	1.1	0.07	1.7	1.8	0.06
Sum (without synthetic gases)	193.0	192.4	-0.57	15.1	15.1	-0.01	12.3	12.7	0.38	220.4	220.2	-0.20

Recalculation	HFC			PFC			SF ₆			Sum (synthetic gases)		
	Prev.	Latest	Differ.	Prev.	Latest	Differ.	Prev.	Latest	Differ.	Prev.	Latest	Differ.
Emissions for 2010												
Source and Sink Categories	CO ₂ equivalent (Gg)									CO ₂ equivalent (Gg)		
2 Ind. Processes (only syn. gases)	6.6	6.7	0.01	0.1	0.1	0.00	0.0	0.0	0.00	6.7	6.7	0.01

Recalculation	Sum (all gases)		
	Prev.	Latest	Differ.
Emissions for 2010			
Source and Sink Categories	CO ₂ equivalent (Gg)		
Total CO₂ eq Em. with LULUCF	227.17	226.98	-0.195
	100.00%	99.91%	-0.086%
Total CO₂ eq Em. without LULUCF	233.17	234.12	0.950
	100.00%	100.41%	0.407%

10.2.2 KP-LULUCF

Table 10-3 shows the differences in the KP-LULUCF tables on emissions/removals in 2010.

Table 10-3 Overview of implications of recalculations on 2010 data for KP-LULUCF. Emissions are shown before the recalculation according to the previous submission in 2012 "Prev." (OEP 2012b) and after the recalculation according to the present submission "Latest".

Source and Sink Categories	CO ₂ equivalent (Gg)		
	Previous	Latest	Difference
A.1.1 Afforestation	-3.257	-0.199	3.057
A.2 Deforestation	0.143	0.141	-0.002
Total emission/removal	-3.114	-0.059	3.055

10.3 Implications for Emissions Trends, including Time Series Consistency

10.3.1 GHG Inventory

Due to recalculations, the emission trend 1990–2010 reported in the 2012 submission has marginally changed. Compared to 1990, 2010 emissions (national total without emissions/removals from LULUCF) showed an increase of 1.10% before recalculation (previous submission). After recalculation, the increase turns out to be slightly higher: 1.65% (latest submission).

Table 10-4 Change of the emission trend 1990–2010 due to recalculations.

Recalculation	1990		2010		change 1990/2010	
	previous	latest	previous	latest	previous	latest
Submission						
	CO ₂ eq (Gg)				%	
Total excl. LULUCF	230.65	230.33	233.17	234.12	1.10%	1.65%

All time series in the present submission are consistent.

10.3.2 KP-LULUCF

The recalculations shown in Table 10-3 (year 2010) lead to similar results also for 2008, 2009 and 2011.

10.4 *Recalculations in Response to the Review Process and Planned Improvements*

10.4.1 GHG Inventory

See Chapter 10.1.1 and Chapter 1.3.3, Incorporated issues according to ERT recommendations from FCCC/ARR 2012.

10.4.2 KP-LULUCF

See Chapter 10.1.2

Part 2

Supplementary Information Required under Article 7, Paragraph 1

11 KP – LULUCF

11.1 *General Information*

The information in this chapter is provided in accordance with Decision 15/CP.10 (FCCC/CP/2004/10/Add.2) and based on the information given in Liechtenstein's Initial Report (OEP 2006a) and the Corrigendum to the Initial Report of 19 Sep 2007 (OEP 2007b).

Liechtenstein has chosen to account annually for emissions and removals from the KP-LULUCF sector (see Chapter 7 of the Initial Report OEP 2006a). The decision remains fixed for the entire first commitment period. Liechtenstein submits data for the fourth mandatory submission year 2011 in this submission.

Table 11-1 shows the activity coverage and the pools reported for the activities under Article 3, paragraph 3 and Forest Management under paragraph 4 of the Kyoto Protocol. The Area change between the previous and the current inventory year is shown in Table 11-2.

Table 11-1 The table contains information of country specific activities under Article 3.3 (KP(LULUCF) NIR 1)

TABLE NIR 1. SUMMARY TABLE**Activity coverage and other information relating to activities under Article 3.3 and elected activities under Article 3.4**

Activity		Change in carbon pool reported ⁽¹⁾					Greenhouse gas sources reported ⁽²⁾						
		Above-ground biomass	Below-ground biomass	Litter	Dead wood	Soil	Fertilization ⁽³⁾	Drainage of soils under forest management	Disturbance associated with land-use conversion to croplands	Liming	Biomass burning ⁽⁴⁾		
							N ₂ O	N ₂ O	N ₂ O	CO ₂	CO ₂	CH ₄	N ₂ O
Article 3.3 activities	Afforestation and Reforestation	R	IE	NR	NR	R	NO			NO	NO	NO	NO
	Deforestation	R	IE	R	R	R			NO	NO	NO	NO	NO
Article 3.4 activities	Forest Management	NA	NA	NA	NA	NA	NA	NA		NA	NA	NA	NA
	Cropland Management	NA	NA	NA	NA	NA			NA	NA	NA	NA	NA
	Grazing Land Management	NA	NA	NA	NA	NA			NA	NA	NA	NA	NA
	Revegetation	NA	NA	NA	NA	NA			NA	NA	NA	NA	NA

⁽¹⁾ Indicate R (reported), NR (not reported), IE (included elsewhere) or NO (not occurring), for each relevant activity under Article 3.3 or elected activity under Article 3.4. If changes in a carbon pool are not reported, it must be demonstrated in the NIR that this pool is not a net source of greenhouse gases. Indicate NA (not applicable) for each activity that is not elected under Article 3.4. Explanation about the use of notation keys should be provided in the text.

⁽²⁾ Indicate R (reported), NE (not estimated), IE (included elsewhere) or NO (not occurring) for greenhouse gas sources reported, for each relevant activity under Article 3.3 or elected activity under Article 3.4. Indicate NA (not applicable) for each activity that is not elected under Article 3.4. Explanation about the use of notation keys should be provided in the text.

⁽³⁾ N₂O emissions from fertilization for Cropland Management, Grazing Land Management and Revegetation should be reported in the Agriculture sector. If a Party is not able to separate fertilizer applied to Forest Land from Agriculture, it may report all N₂O emissions from fertilization in the Agriculture sector.

⁽⁴⁾ If CO₂ emissions from biomass burning are not already included under changes in carbon stocks, they should be reported under biomass burning; this also includes the carbon component of CH₄. Parties that include CO₂ emissions from biomass burning in their carbon stock change estimates should report IE (included elsewhere).

Table 11-2 KP(LULUCF) NIR 2 - Land Transition Matrix 2011.

Areas and changes in areas between the previous and the current inventory year ^{(1), (2), (3)}

To current inventory From previous inventory year		Article 3.3 activities		Article 3.4 activities				Other ⁽⁵⁾	Total area at the beginning of the current inventory year ⁽⁶⁾
		Afforestation and Reforestation	Deforestation	Forest Management (if elected)	Cropland Management (if elected)	Grazing Land Management (if elected)	Revegetation (if elected)		
		(kha)							
Article 3.3 activities	Afforestation and Reforestation	0.03	NO						0.03
	Deforestation		0.02						0.02
Article 3.4 activities	Forest Management (if elected)		0.00	NA					0.00
	Cropland Management ⁽⁴⁾ (if elected)	NA	NA		NA	NA	NA		NA
	Grazing Land Management ⁽⁴⁾ (if elected)	NA	NA		NA	NA	NA		NA
	Revegetation ⁽⁴⁾ (if elected)	NA			NA	NA	NA		NA
Other ⁽⁵⁾		0.00	NA	NA	NA	NA	NA	NA	0.00
Total area at the end of the current inventory year		0.04	0.02	NA	NA	NA	NA	NA	0.06

⁽¹⁾ This table should be used to report land area and changes in land area subject to the various activities in the inventory year. For each activity it should be used to report area change between the previous year and the current inventory year. For example, the total area of land subject to Forest Management in the year preceding the inventory year

⁽²⁾ Some of the transitions in the matrix are not possible and the cells concerned have been shaded.

⁽³⁾ In accordance with section 4.2.3.2 of the IPCC good practice guidance for LULUCF, the value of the reported area subject to the various activities under Article 3.3 and 3.4 for the inventory year should be that on 31 December of that year.

⁽⁴⁾ Lands subject to Cropland Management, Grazing Land Management or Revegetation which, after 2008, are subject to activities other than those under Article 3.3 and 3.4, should still be tracked and reported under Cropland Management, Grazing Land Management or Revegetation, respectively.

⁽⁵⁾ "Other" includes the total area of the country that has not been reported under an Article 3.3 or an elected Article 3.4 activity.

⁽⁶⁾ The value in the cell of row "Total area at the end of the current inventory year" corresponds to the total land area of a country and is constant for all years.

Table 11-3 KP(LULUCF) NIR 3 – Key Categories.

TABLE NIR 3. SUMMARY OVERVIEW FOR KEY CATEGORIES FOR LAND USE, LAND-USE CHANGE AND FORESTRY ACTIVITIES UNDER THE KYOTO PROTOCOL

KEY CATEGORIES OF EMISSIONS AND REMOVALS	GAS	CRITERIA USED FOR KEY CATEGORY IDENTIFICATION			COMMENTS ⁽³⁾
		Associated category in UNFCCC inventory ⁽¹⁾ is key (indicate which category)	Category contribution is greater than the smallest category considered key in the UNFCCC inventory ^{(1),(4)} (including LULUCF)	Other ⁽²⁾	
Specify key categories according to the national level of disaggregation used ⁽¹⁾					
Afforestation and Reforestation	CO2	Conversion to forest land	No	Quantitative criteria for key	Level and Trend Assessment following IPCC 1997 and IPCC LULUCF GPG 2003.
Deforestation	CO2	Conversion to grassland	No	Quantitative criteria for key	Level and Trend Assessment following IPCC 1997 and IPCC LULUCF GPG 2003.

⁽¹⁾ See section 5.4 of the IPCC good practice guidance for LULUCF.

⁽²⁾ This should include qualitative consideration as per section 5.4.3 of the IPCC good practice guidance for LULUCF or any other criteria.

⁽³⁾ Describe the criteria identifying the category as key.

⁽⁴⁾ If the emissions or removals of the category exceed the emissions of the smallest category identified as key in the UNFCCC inventory (including LULUCF), Parties should indicate YES. If not, Parties should indicate NO.

Table 11-4 Overview on net CO₂ equivalent emissions (positive sign) and removals (negative sign) for activities under Article 3, paragraph 3 of the Kyoto Protocol in 2011.

Activity	Area (cumulated 1990-2011) kha	Net CO ₂ emission/removal
		2011 Gg CO ₂
Afforestation	0.03	-0.18
Deforestation	0.02	0.39
Total net CO₂ emission/removal		0.21

The afforested area caused removals of -0.182 Gg CO₂ in 2011. Deforestation occurring 1992-2011 emitted 0.393 Gg CO₂ in 2011. Therefore net emissions of 0.211 Gg CO₂ are resulting. In previous submissions net removals resulted from the calculations, but with the new methodological approach this has changed now.

11.1.1 Definition of Forest and any other Criteria

11.1.1.1 Definition of Forest

For activities under Article 3, paragraphs 3 and 4 of the Kyoto Protocol, the Marrakech Accords (in the annex to decision 16/CMP.1) list the definitions to be specified by Parties. Liechtenstein's definitions for Forest, Afforestation and Deforestation are specified in the corrigendum to Liechtenstein's Initial Report (OEP 2007b, see there in Chapter 4) and summarized below. Liechtenstein applies the forest definition of the Swiss Land Use Statistics (AREA) of the Swiss Federal Statistical Office. AREA provides an excellent data base to derive accurate, detailed information of not only forest areas, but all types of land use and land cover. Thus, AREA offers a comprehensive, consistent and high quality data set to estimate the surface area of the different land use categories in reporting under the Kyoto Protocol. For Liechtenstein, the Land Use Statistics has been built up identically to Switzerland (same method and data structures, same realisation)

- minimum area of land: 0.0625 hectares (with a minimum width of 25 m)
- minimum crown cover: 20 per cent

- minimum height of the dominant trees: 3 m (dominant trees must have the potential to reach 3 m at maturity in situ)

In Liechtenstein's Initial Report, the following precisions are stated (OEP 2006a, p.20f.):

The following forest areas are not subject to the criterion of minimum stand height: shrub forest consisting of dwarf pine (*Pinus mugo prostrata*) and alpine alder (*Alnus viridis*).

The following forest areas are not subject of the criteria of minimum stand height **and** minimum crown cover, but must have the potential to achieve both criteria:

- a) afforested area on land not under forest cover for 50 years (afforestations);
- b) regenerated forest, as well as burned, cut or damaged areas situated on land classified as forest.

Although orchards, parks, camping grounds, open tree formations in settlements, gardens, cemeteries, sports and parking fields may fulfil the (quantitative) forest definition, they are not considered as forests.

The definitions given below refer exclusively to **directly human-induced** activities:

11.1.1.2 Afforestation

Definition: Afforestation is the conversion to forest of an area not fulfilling the definition of forest for a period of at least 50 years if

- (a) the definition of forest in terms of minimum area (625 m²) is fulfilled, and
- (b) the conversion is a direct human-induced activity.

Natural forest regeneration due to abandonment of agricultural land use land is not considered to be a direct human-induced activity.

The area of forest land reported for Afforestation under the Kyoto Protocol is equal to the area reported for Land use changes to forests (see Chapter 7.3.2.2). Afforestations in Liechtenstein are identified

- by aerial photographs which form the basis of Liechtenstein's Land-Use Statistics. In afforestations, the trees are planted in regular patterns, which may easily be recognised in the identification process. This procedure is carried out for all afforestations that happened before 2002 where the latest land-use photographs were taken.
- The afforestations which are identified by aerial photographs by method referred to above are compared with the administrative registers on afforestations endorsed by the Office of Forest, Nature and Landscape since 1990. Through this cross check the consistency of the two data sources are verified.
- Afforestations in the period after 2003 will be identified referring to the administrative registers on afforestations endorsed by the Office of Forest, Nature and Landscape. Since afforestations need legal authorisation (Art. 12 and Art 24 of Forest Law), every afforestation is documented in a proper project containing information on geographic location, area, appointed time etc. Since subsidies are granted for afforestations, they are also documented in the national finances. After being afforested, an area is also legally characterised as forest.
- To ensure that the total area of forest does not decrease (Forest law Art. 1), areas affected by direct human-induced activities have to be compensated (Forest law Art. 7), mainly by afforestation of the same spatial extent. Natural forest regeneration due to higher temperatures (rising of timberline) or the abandonment of agricultural land use,

mainly occurring in the Alpine area, is not counted as afforestation and is therefore not counted under Article 3, paragraph 3 of the Kyoto Protocol.

Afforestations since 1990 were not subject to harvesting or clear cutting, since there are no forests with such short rotation lengths. For reporting under the Kyoto Protocol, afforested areas always remain in the “afforestation” category. Therefore, the area of afforestations is increasing since 1990.

11.1.1.3 Deforestation

Definition: Deforestation is the permanent conversion of areas fulfilling the definition of forest in terms of minimum forest area (625 m²) to areas not fulfilling the definition of forest as a consequence of direct human influence.

Deforestation is prohibited by the National Law on Forests with article 6 (Government 1991). Exceptions need governmental authorisation. The authorisation documents are collected by the Office of Forest, Nature and Landscape (OFNLM) and are annually reported to the Parliament. To ensure that the total area of forest does not decrease, areas affected by direct human-induced deforestation have to be compensated, mainly by afforestation of the same spatial extent but not at the same location. Natural forest regeneration due to abandonment of land, mainly occurring in the Alpine area, is not counted as afforestation and is therefore not counted under Article 3, paragraph 3 of the Kyoto Protocol.

In Liechtenstein, human-induced deforestation is subject to authorisation as mentioned above. Authorisations include the obligation to regenerate the forest area within a few years as part of substitute measures in other areas. Nevertheless such land-use change is classified as permanent deforestation and accordingly accounted for under Article 3, paragraph 3 of the Kyoto Protocol.

The area of forest land reported for Deforestation under the Kyoto Protocol is equal to the sum of deforested areas each with a minimal extension of 625 m² and for which authorisation has been granted by the Government of Liechtenstein (that means that deforestations with an area smaller than 625 m² are not reported under the Kyoto Protocol). Every single authorisation is documented including information on area as well as schedule and maps in the “Rodungsstatistik” (see Table 11-5).

The area reported for KP-LULUCF differs from the area of deforested land reported in the UNFCCC greenhouse gas inventory (Chapters 7.2.2 and 7.2.4) due to the required distinction in the KP-LULUCF Inventory between human-induced deforestation and not human-induced deforestation.

11.1.1.4 Reforestation

Reforestation does not occur in Liechtenstein (see Sect. 11.4.1).

11.1.1.5 Information used for completing Kyoto tables

The spatial assessment unit for the submission of the Kyoto Protocol LULUCF tables 2011 covers the entire territory of Liechtenstein.

Since all forests in Liechtenstein are subject to forest management, the area of managed forest corresponds to the forest area derived from the Liechtenstein’s Land Use Statistics (EDI/BFS 2009).

11.1.2 Elected Activities under Article 3, paragraph 4, of the Kyoto Protocol

Liechtenstein has elected to not account for LULUCF activities under Article 3.4 during the first commitment period²⁶, as stated in its Initial Report (OEP 2006b, p.22).

11.1.3 Description of how the definitions of each activity under Article 3.3 have been implemented and applied consistently over time

See Chapter 11.1.1.1. All time-series are consistent.

11.1.4 Precedence Conditions / Hierarchy, Determination among Article 3.4. activities

Liechtenstein has decided not to account for activities under Article. 3.4.

11.2 Land-related Information

11.2.1 Spatial Assessment Unit used for determining the Area of the units of Land

The spatial assessment unit for the submission of the KP LULUCF tables 2011 covers the entire territory of Liechtenstein.

11.2.2 Methodology used to develop the Land transition Matrix

The methodology used to develop the land transition matrix is described in detail in Chapter 7.2.4.

11.2.3 Maps / Database to identify the geographical Locations and the system of identification Codes for the geographical Locations

See Chapter 11.1.1.1 and also Figure 7-3, Table 7-3 and Table 7-4 in Chapter 7.2.

11.3 Activity-specific Information

11.3.1 Methods for Carbon Stock Change and GHG Emission and Removal estimates

11.3.1.1 Description of the Methodologies and the underlying Assumptions used

Afforestations

Gross growth of living biomass (carbon stock change in above and below ground biomass) was calculated with the growth rates of land-use category CC11 given in Table 7-8.

²⁶ Regierung des Fürstentums Liechtenstein: Kyoto-Protokoll – Initial Report – Anrechnung von Senken, RA 2006/2168-8642, Vaduz, 05.09.2006

In Liechtenstein, afforestations mostly occur on grasslands. Therefore, the changes in soil carbon are based on the difference in soil carbon stocks between permanent grasslands (CC31) and afforestations (CC11) for the three altitude zones z1, z2 and z3 (≤ 600 m, 601-1200 m, > 1200 m) and the soil type mineral soil (Table 7-8). The resulting increase in soil carbon was evenly distributed over the IPCC default conversion time of 20 years, giving an evenly distributed yearly change in soil carbon stock to move from the soil carbon stock level of grasslands to the level of productive forests.

The afforested areas (CC11) were calculated by the methods shown in Chapter 7.2.2. The areas of afforestation are given in the land-use change-matrices (Table 7-7, Table A-7 and A-8). Table 11-5 summarises all values per year and the cumulative areas used for calculating carbon fluxes under this activity.

Table 11-5 Area and cumulative area of afforestations (CC11) 1990-2012. The cumulative area is calculated over 20 years since 1990.

Year	altitude zone			total	cumulated 20 years
	z1	z2	z3		
1990	1.00	0.08	2.08	3.17	3.17
1991	1.00	0.08	2.08	3.17	6.33
1992	1.00	0.08	2.08	3.17	9.50
1993	1.00	0.08	2.08	3.17	12.66
1994	1.00	0.08	2.08	3.17	15.83
1995	1.00	0.08	2.08	3.17	19.00
1996	1.00	0.08	2.08	3.17	22.16
1997	0.50	0.50	0.50	1.50	23.66
1998	0.50	0.50	0.50	1.50	25.17
1999	0.50	0.50	0.50	1.50	26.67
2000	0.50	0.50	0.50	1.50	28.17
2001	0.50	0.50	0.50	1.50	29.67
2002	0.50	0.50	0.50	1.50	31.17
2003	0.00	0.17	0.33	0.50	31.68
2004	0.00	0.17	0.33	0.50	32.18
2005	0.00	0.17	0.33	0.50	32.68
2006	0.00	0.17	0.33	0.50	33.18
2007	0.00	0.17	0.33	0.50	33.68
2008	0.00	0.17	0.33	0.50	34.18
2009	0.00	0.17	0.17	0.33	34.51
2010	0.00	0.17	0.17	0.33	31.68
2011	0.00	0.17	0.17	0.33	28.85
2012	0.00	0.17	0.17	0.33	26.02

Deforestations

Change in total carbon stock of living biomass, litter and dead wood is modelled by using the deforested area in the respective year (see Table 11-7) and the carbon stocks per altitude zone of land-use category CC12 from Table 7-8. I.e. in the case of deforestation, all the carbon in living biomass, dead wood and litter is immediately removed in the same year..

For calculating the loss in soil carbon pool a conversion time of 20 years is applied. Accordingly, the cumulated areas as shown in Table 11-7 are used. It is assumed (Covington 1981, Rusch et. al. 2009) that the soil carbon content of CC12 (92.7 t ha^{-1} , see Table 7-8) is reduced by 50% within this time.

The deforested areas per altitude zone (Table 11-7) are calculated on the basis of the deforestation events (Table 11-6) registered by the Office of Forests, Nature and Land Management.

Table 11-6 Deforestation data 1990-2011 communicated by the Office of Forests, Nature and Land Management (OFNLM) to Office of Environmental Protection (OEP) per altitude zone z1, z2, z3 (≤ 600 m, 601-1200 m, > 1200 m)

Year	Owner	Cause, location	Area (m ²)	z1	z2	z3
1990	Gemeinde Vaduz	Regierungsviertel	3'350	x		
1992	Gemeinde Triesenberg	Wohncontainer (!)	1'095		x	
1994	Gemeinde Eschen	Deponie Rheinau	62'000	x		
1995	Gemeinde Ruggell	Erweiterung Industriezone	5'160	x		
1995	Gemeinde Triesen	Regenüberlaufbecken Leitawies	900	x		
1996	Gemeinde Vaduz	Erweiterung Tennisplätze	1'330	x		
1998	Gemeinde Schaan	Deponie Ställa	3'320	x		
1998	Gemeinde Triesenberg	Werkhöfe Guferwald	2'350		x	
2000	Gemeinde Gamprin	ARA, Bendern	10'500	x		
2000	Gemeinde Ruggell	Erweiterung Steinbruch	5'000	x		
2001	Gemeinde Schaan	Deponie Ställa	18'000	x		
2002	Gemeinde Schaan	Deponie Ställa	10'100	x		
2002	Gemeinde Triesen	Erweiterung Sportplatz T'berg	9'850		x	
2003	Gemeinde Gamprin	Betonwerk Wilhelm Büchel	950	x		
2003	Gemeinde Triesen	Deponie Säga	6'000	x		
2003	Gemeinde Vaduz	Deponie Rain	8'000	x		
2004	Gemeinde Gamprin	Erstellung Trottoir "Kehla"	735	x		
2004	Gemeinde Schaan	Deponie Ställa	18'800	x		
2004	Gemeinde Triesenberg	Arealerweiterung Leitawies	3'995	x		
2005	Gemeinde Vaduz	Deponie Rain	9'000	x		
2005	Gemeinde Vaduz	Fussballplatzausbau	1'510	x		
2006	Gemeinde Ruggell	Erweiterung Steinbruch	7'200	x		
2006	Gemeinde Vaduz	Bergbahnen Malbun	7'630			x
2006	Gemeinde Triesenberg	Aussiedlungsbetriebe Studa	1'710		x	
2007	Gemeinde Triesen	Erweiterung Motocrosspiste	1'200	x		
2008	Gemeinde Balzers	Unterhaltungsweg Rheindamm	1'000	x		
2008	Gemeinde Schaan	Erstellung Dampfleitung	2'210	x		
2009	Gemeinde Ruggell	Gewerbezone "Flandera"	4'470	x		
2011	Gemeinde Mauren	Projekt Egelsee	1'810	x		
2011	Gemeinde Schaan	Projekt Pfarrmeder	760	x		
2011	Gemeinde Eschen	Recyclingplatz Deponie	1'240	x		

Table 11-7 Area and cumulative area (ha) of deforestations per year and per altitude zone 1990-2011. The cumulative area* is calculated over 20 years since 1990.

Year	cumulated		cumulated		cumulated		total cumulated area*
	z1	area*	z2	area*	z3	area*	
1990	0.34	0.34		0.00		0.00	0.34
1991		0.34		0.00		0.00	0.34
1992		0.34	0.11	0.11		0.00	0.44
1993		0.34		0.11		0.00	0.44
1994	6.20	6.54		0.11		0.00	6.64
1995	0.61	7.14		0.11		0.00	7.25
1996	0.13	7.27		0.11		0.00	7.38
1997		7.27		0.11		0.00	7.38
1998	0.33	7.61	0.24	0.34		0.00	7.95
1999		7.61		0.34		0.00	7.95
2000	1.55	9.16		0.34		0.00	9.50
2001	1.80	10.96		0.34		0.00	11.30
2002	1.01	11.97	0.99	1.33		0.00	13.30
2003	1.50	13.46		1.33		0.00	14.79
2004	2.35	15.81		1.33		0.00	17.14
2005	1.05	16.87		1.33		0.00	18.19
2006	0.72	17.59	0.17	1.50	0.76	0.76	19.85
2007	0.12	17.71		1.50		0.76	19.97
2008	0.32	18.03		1.50		0.76	20.29
2009	0.45	18.47		1.50		0.76	20.74
2010		18.14		1.50		0.76	20.40
2011	0.38	18.52		1.50		0.76	20.78

11.3.1.2 Justification when omitting any Carbon Pool or GHG Emissions/Removals from Activities

KP-LULUCF Table NIR 1 (see Table 11-2) summarizes the activity coverage and the pools reported.

When using the conservative Tier 1 approach (IPCC 2003, Sect. 3.1.5) assuming a specific carbon pool to be in carbon balance, the carbon pool is indicated as reported (R).

The pool "above ground biomass" always reflects the total living biomass, which was calculated by applying the BEF factor (see Chapter 7.3.2.1). The BEF includes the total biomass of the wood pool as described in Thürig et. al (2005). Round wood over bark was expanded to total biomass by applying allometric single tree functions to all trees measured. Since we cannot separate the above and below ground biomass carbon pool, below ground biomass is included in the above ground biomass pool and therefore always marked as "included elsewhere" (IE). This methodology is in line with the Swiss methodology (FOEN 2010) which underwent in-country review in 2010 and was approved to be in line with the guidelines.

On Grasslands there is no litter and no dead wood and mostly a lower carbon stock level than in forests. Because an increase of carbon in these pools is expected after a conversion from grasslands to forests (afforestations) (compare Table 7-8 of the NIR) a Tier 1 approach has been considered in terms of IPCC good practice (IPCC 2003, Sect. 3.1.5) and no changes (NR) in the litter and dead wood pools for afforestations has been reported.

Fertilisation, drainage of soils, disturbance associated with land-use conversion to croplands, liming and biomass burning are not occurring (NO)

Thus, for Liechtenstein only the two lines (rows) with „Articles 3.3 activities“ apply (Table 11-2).

11.3.1.3 Information on whether or not indirect and natural GHG Emissions and Removals have been factored out

No anthropogenic greenhouse gas emissions and removals resulting from LULUCF activities under Article 3, paragraph 3 and 4 have been factored out.

11.3.1.4 Changes in Data and Methods since the previous Submission (Recalculations)

Data for afforestation and deforestation were recalculated due to corrections of calculation errors (see Chapters 10.1.2 and 10.2.2).

11.3.1.5 Uncertainty Estimates

The uncertainties for afforestation and deforestation are estimated as follows:

Afforestation:

AD uncertainty is 20% and EF uncertainty is 36% according to Table 1-6. 5A2 "Land converted to Forest Land". The combined total uncertainty for afforestation is therefore 21.9%. Thus the net CO₂ removal by afforestation is – 0.18 Gg CO₂ ± 0.04 Gg CO₂.

Deforestation:

AD uncertainty is estimated to be 1% due to the very exact data on deforestations in Liechtenstein (Rodungsstatistik), where every single deforestation has to be authorised.

EF uncertainty of 50% is taken from the uncertainty estimate for 5E2 "Land converted to settlements" (see Table 1-6) as this is the main reason for conversion of forest land.

The combined total uncertainty for deforestation is therefore 32.5%. The net CO₂ emissions by deforestations are 0.39 Gg CO₂ ± 0.13 Gg CO₂.

Total combined uncertainty:

The total combined uncertainty of afforestation and deforestation is 63.5%. The net CO₂ emissions are therefore 0.21 Gg CO₂ ± 0.13 Gg CO₂.

11.3.1.6 Other methodological Issues

Time series are consistent.

11.4 Article 3.3.

Table NIR 1

Table NIR 1 (see Table 11-1) of the KP-LULUCF Inventory lists all the relevant Article 3.3 data.

Table NIR 2

The change in area related to Activities under Article 3, paragraph 3 between the previous and current inventory year is listed in Table 11-2 (Table NIR 2). For Liechtenstein, only columns with „Articles 3.3 activities“ apply. Area changes from afforestation to deforestation did not occur with the period 1990-2011 as explained above in Chapter 11.1.1.1.

- Afforestation:

- The cumulated area of afforestation 1990-2010 is reported in the cell from “Afforestation and reforestation” to “Afforestation and reforestation”. Calculation is based on values presented in Table 11-5.
- The area change between the previous and the current inventory year, 2010 and 2011 respectively, is reported in the cell from “Other” to “Afforestation and Reforestation”.
- Deforestation:
 - The cumulated area of deforestation 1990-2010 is reported in the cell from “Deforestation” to “Deforestation”. Calculation is based on values presented in Table 11-7.
 - The area change between the previous and the current inventory year, 2010 and 2011 respectively, is reported in the cell from “Forest management” to “Deforestation”. If no deforestation has occurred in the specific year, “NO” is reported. Even though Liechtenstein has decided not to account for Article 3.4. activities this figure has to be reported under Art. 3.4. activities, being relevant for Art. 3.3. activity deforestation.

Table NIR 3

The table summarizes information on key categories (Table 11-3). See comments in Chapter 11.6.1.

Further Kyoto tables 5(KP)A

- 5(KP-I)A.1.1 Afforestation: Change in carbon stock is modelled as explained in Chapter 11.3.1.1
- 5(KP-I)A.1.2 Afforestation: there are no units of land afforested later than 1990 and harvested subsequently.
- 5(KP-I)A.2 Deforestation: Change in carbon stock is modelled as explained in Chapter 11.3.1.1. Note that the overview table NIR-2 of the KP-LULUCF tables shows the cumulated area of deforested land since 1990. In contrary, calculation of carbon stock change in soils is based on the cumulative deforested area over a conversion period of 20 years.

Since carbon from living biomass is immediately removed after clear-cutting, Deforestations can be considered as a “quick carbon-losing process” (except for soil carbon). In contrast, due to the slow increase of living biomass, Afforestations are a “more slow process with increasing importance” in terms of carbon accumulation.

11.4.1 Information that demonstrates that Activities under Article 3.3. began on or after 1 January 1990 and before December 2012 and are direct Human-induced

Liechtenstein’s definitions of afforestation and deforestation only consider directly human-induced activities.

Reforestation

For more than 100 years, the area of forest in Liechtenstein has been increasing, and a decrease in forest area as a result of deforestation is prohibited by the National Law on Forests with article 6 (Government 1991). Therefore, reforestation of areas not forested for a

period of at least 50 years does not occur in Liechtenstein. Liechtenstein therefore, only has to consider afforestation and deforestation under Article 3, paragraph 3.

Afforestation

The annual rate of Afforestation since 1990 is assessed by AREA (see Chapter 7.3.2.2). For reporting under the Kyoto Protocol, afforested areas always remain in the “afforestation” category. Therefore, the area of Afforestations is increasing since 1990.

Afforestations since 1990 were not subject to harvesting or clear cutting, since there are no forests with such short rotation lengths.

Deforestation

Deforestation is prohibited by the National Law on Forests with article 6 (Government 1991) and exceptions need governmental authorisation. The authorisation documents are collected by the Office of Forest, Nature and Landscape (OFNLM) and are annually reported to the Parliament. Therefore data on Deforestation is very detailed (area of the forest, reason for deforestation). Only deforestations carried out after 1 January 1990 are considered.

11.4.2 Information on how Harvesting or Forest Disturbance that is followed by the Re-Establishment of Forest is distinguished from Deforestation

Liechtenstein’s definition for deforestation only covers permanent conversions from forest land into non-forest land and thus implicitly distinguishes between permanent conversions and transient situations like harvesting or forest disturbance.

11.4.3 Information on the Size and Geographical Location of Forest Areas that have lost Forest Cover but which are not yet classified as Deforested

There is a discrepancy between the directly human-induced deforest area retrieved from the “Rodungsstatistik” (Table 11-6) on the one hand and the area which changes from a forest-land combination category to a non-forest land combination category displayed in the Land-Transition Matrix, as determined by AREA (see also Chapter 7.3.2.2), on the other hand.

To investigate these differences between both data bases a study was initiated in Switzerland in autumn 2009 (Rihm et al. 2010, FOEN 2010d). The results show that a major part of the conversions from a forest-land combination category to a non-forest land combination category is due to the management of forest edges or the management of open forests on agricultural areas (so called “Wytweiden”). These management practices are part of the sustainable management of Swiss forests. A temporal decline in tree cover can lead to the conversion in a non-forest land category (e.g. CC32 grassland with perennial woody biomass) according to the AREA classification. These results hold also true for Liechtenstein as the same methodology was applied and therefore, we consider these conversions also as temporal and therefore do not report these changes as “deforestation”.

11.5 Article 3.4

Liechtenstein has decided not to account for activities under Article. 3.4

11.6 Other Information

11.6.1 Key Category Analysis for Article 3.3. activities

As stated in the IPCC Good Practice Guidance for LULUCF (IPCC 2003), the basis for assessment of key categories under Articles 3.3 and 3.4 of the Kyoto Protocol is the same as the assessment made for the UNFCCC inventory. Note that Liechtenstein has elected to not account for LULUCF activities under Article 3.4 during the first commitment period (OEP 2006a). Therefore only the categories afforestation/reforestation and deforestation are reported for the KP Inventory.

Among the key categories from the LULUCF sector in the UNFCCC inventory, there are three categories which have a relationship to afforestation/reforestation or deforestation, according to table 5.4.4 in the IPCC Good Practice Guidance for LULUCF:

- 5C2 Land converted to Grassland: related to deforestation
- 5D2 Land converted to Wetlands: related to deforestation
- 5E2 Land converted to Settlements: related to deforestation

Afforestation occurs in more than one category of the UNFCCC inventory. As recommended by the IPCC Good Practice Guidance for LULUCF, in this case the total emissions and removals from the activity are considered for purposes of the key category analysis. The total from the activity afforestation in 2011, as reported with the present submission, is a removal of 0.18 Gg CO₂. The smallest category that is identified as key in the UNFCCC inventory (combined KCA without and with LULUCF categories) is 4D3 Indirect Emissions from Agricultural Soils with 2.59 Gg CO₂ emissions. This means that the total for afforestation is smaller than the emissions from the smallest category that is identified as key in the UNFCCC inventory. Therefore Afforestation is not considered to be a key category. While deforestation on the other hand with 0.39 Gg CO₂ emissions is greater than the emissions from 4D3 and therefore considered as key category.

11.7 Information Relating to Article 6

Liechtenstein currently does not host projects under the Joint Implementation Mechanism.

12 Accounting on Kyoto Units

12.1 Background Information

The standard electronic format (SEF) is part of the submission under Article 7.1 of the Kyoto Protocol in accordance with decisions 11/CP.4, 14/CMP.1 and 15/CMP.1. The SEF Tables have been developed to facilitate the reporting and the review of Kyoto Protocol units by Annex-I Parties.

Additionally several reports for the Standard Independent Assessment Report (SIAR) have to be submitted by a Party, matching the requirements of Decision 14/CMP.1 and 15/CMP.1

12.2 Summary of Information Reported in the SEF Tables

The tables of the Standard Electronic Format (SEF) providing all necessary information on Kyoto units (AAU, CER, ERU, tCER, ICER and RMU) for 2011 have been submitted together with this report (NIR 2012). Details are disclosed in the corresponding file SEF_LI_2013_1_13-22-40 8-4-2013.

12.3 Discrepancies and Notifications

The following information on Kyoto units are covered by the Annex of Decision 15/CMP.1 Part I.E para 12 to 17:

Para. 12: No discrepant transactions occurred in 2012

Para. 13/14: No CDM notifications occurred in 2012.

Para. 15: No non-replacements occurred in 2012.

Para. 16: No invalid units exist as at 31 December 2012.

Para. 17: Necessary actions have been undertaken to correct any problem causing a discrepancy in the reporting year 2012. All relevant transactions were terminated.

12.4 Publicly Accessible Information

Pursuant to paragraphs 44 to 48 in section I.E of the annex to decision 13/CMP.1, Liechtenstein makes non-confidential information available to public using Registry Homepage and/or user interface. In Liechtenstein the following information is considered as non-confidential and publicly accessible on website <http://ec.europa.eu/environment/ets/>.

13/CMP.1 annex II paragraph 45

Account information

The requested information is publicly available for all accounts. The data of operator holding accounts can be viewed online at:

<http://ec.europa.eu/environment/ets/account.do?languageCode=en&account.registryCodes=LI&account.accountFullTypeCodes=100-0-7&identifierInReg=&accountHolder=&search=Search&searchType=account¤tSortSettings=http://ec.europa.eu/environment/ets/account.do?languageCode=en&account.registryCodes=LI&account.accountFullTypeCodes=100-0-7&identifierInReg=&accountHolder=&search=Search&searchType>

	<p>=account&currentSortSettings=</p> <p>The data of all accounts can be viewed online at:</p> <p>http://ec.europa.eu/environment/ets/account.do?languageCode=en&account.registryCodes=LI&identifierInReg=&accountHolder=&search=Search&searchType=account&currentSortSettings=</p> <p>Representative name and contact information is classified as confidential due to Article 83 paragraph 8 and 9 Registry Regulation No. 1193/2011.</p>
<p>13/CMP.1 annex II paragraph 46</p> <p>Joint implementation project information</p>	<p>This information is available on the website:</p> <p>http://www.llv.li/amtsstellen/llv-aus-emissionshandel_en/llv-aus-emissionshandelsregister_flexible_mechanismen_en/llv-aus-emissionshandel-genehmigte_projekte_en.htm</p>
<p>13/CMP.1 annex II paragraph 47</p> <p>Unit holding and transaction information</p>	<p>The information requested in (a), (d), (f) and (l) is classified as confidential due to Article 83 paragraph 1 Registry Regulation No. 1193/2011 as well as national data protection law and therefore not publicly available. Transactions of units within the most recent five year period are also classified as confidential, therefore the transactions provided are only those completed more than five years in the past.</p> <p>The information requested in (b), (c), (e), (g), (h), (i), (j) and (k) is publicly available at</p> <p>(b) In 2012 there was no issuance of AAU.</p> <p>(c) In 2012 no ERUs were issued.</p> <p>(e) No RMU was issued in the reported year.</p> <p>(g) No RMU was cancelled on the basis of activities under Article 3, paragraph 3 and 4 in the reported year.</p> <p>(h) No ERU, CER, AAU and RMU were cancelled on the basis of activities under Article 3, paragraph 1 in the reported year.</p> <p>(i) In 2012, no AAU, no ERU and no CER were voluntary cancelled. No RMU was cancelled.</p> <p>(j) In 2012, no ERU, no CER, no AAU, and no RMU, tCER, ICER were retired.</p> <p>(k) There was no carry over of ERU, CER, AAU or RMU from the previous commitment period.</p>
<p>13/CMP.1 annex II paragraph 48</p> <p>Authorized legal entities information</p>	<p>The following legal entities are authorized by the Member State to hold Kyoto units:</p>

	Legal entities authorised by Liechtenstein to hold units
AAU	Federal Government, TA
ERU	Each account holder of OHA, PHA, TA and NHA
CER	Each account holder of OHA, PHA, TA and NHA
RMU	Federal Government only, TA
tCER	Federal Government only, TA
ICER	Federal Government only, TA

OHA: Operator Holding Account (installation and aircraft)

PHA: Person Holding Account

TA: Trading Account

NHA: National Holding Account

Additionally all required information on Article 6 projects (JI) would be available on the internet website of the Office of Environment (OE) if there would be such a project in Liechtenstein. So far, there are no JI projects in Liechtenstein.;

http://www.llv.li/amtstellen/llv-aus-emissionshandel_en/llv-aus-emissionshandelsregister_flexible_mechanismen_en/llv-aus-emissionshandel-genehmigte_projekte_en.htm). These informations comprise name of projects, host counties, available documents and dates.

Personalized data and some information of individual holding accounts are considered as business secrets and the disclosure may prejudice their competitiveness. Information on acquiring and transferring accounts of legal entities (companies) is therefore regarded as personal data. According to article 20 of the national Act on Data Protection (Datenschutzgesetz vom 14. März 2002, LGBl Nr.55) enacts that public authorities may disclose personal data if there is a legal basis or if there is an overriding public interest. Neither case is fulfilled and therefore the registry of Liechtenstein can not make the information on acquiring and / or transferring accounts publicly available. All related information is considered as **confidential** and therefore paragraphs 44-40 of the Annex to Decision 13/CMP.1 are not applicable.

12.5 Calculation of the Commitment Period Reserve (CPR)

No changes compared to submission 2012. According to the Annex of decision 11/CMP.1, each Party included in Annex I shall maintain, in its national registry, a commitment period reserve which should not drop below 90 per cent of the Party's assigned amount calculated

pursuant to Article 3, paragraphs 7 and 8, of the Kyoto Protocol, or 100 per cent of five times its most recently reviewed inventory, whichever is lowest. In line with these specifications, Liechtenstein reported its commitment period reserve to be 950.061 Gg CO₂ eq based on the assigned amount, which is consistent with the initial review report 2006 (FCCC/IRR 2007).

Liechtenstein considers that the „most recently reviewed inventory“ refers to the inventory 2007 presented in the current NIR.

In order to determine which of the two methods to calculate the commitment period reserve results in the lower value, the results of both methods are indicated in Table 12-1.

Table 12-1 Calculation of Liechtenstein's commitment period reserve 2011.

Method 1		Method 2	
Assigned amount calculated pursuant to Art. 3, para. 7 and 8 of the Kyoto protocol (five times 92% of 1990 emissions), see OEP (2007b) [Gg CO ₂ equivalent]	1'055.623	2011 emissions without LULUCF, see Table 2-1 [Gg CO ₂ equivalent]	222.00
90% of the assigned amount [Gg CO ₂ equivalent]	950.061	100% of five times the 2011 emissions without LULUCF [Gg CO ₂ equivalent]	1110.00

The CPR remains unchanged since method 1 still results in the lower value and is therefore used to calculate the minimum amount of the CPR. **The commitment period reserve of Liechtenstein should therefore not drop below 950.061 Gg CO₂ equivalent (0.950061 million tonnes CO₂ equivalent).**

12.6 KP-LULUCF Accounting

Liechtenstein does not account for KP LULUCF. Therefore the inventory is understood to be calculated without LULUCF emissions/removals.

13 Changes in National System

The National System remained unchanged in the inventory cycle 2010.

14 Information on changes in national registry

Directive 2009/29/EC adopted in 2009, provides for the centralization of the EU ETS operations into a single European Union registry operated by the European Commission as well as for the inclusion of the aviation sector. At the same time, and with a view to increasing efficiency in the operations of their respective national registries, the EU Member States who are also Parties to the Kyoto Protocol (25) plus Iceland, Liechtenstein and Norway decided to operate their registries in a consolidated manner in accordance with all relevant decisions applicable to the establishment of Party registries - in particular Decision 13/CMP.1 and decision 24/CP.8.

With a view to complying with the new requirements of Commission Regulation 920/2010 and Commission Regulation 1193/2011, in addition to implementing the platform shared by the consolidating Parties, the registry of EU has undergone a major re-development. The consolidated platform which implements the national registries in a consolidated manner (including the registry of EU) is called Consolidated System of EU registries (CSEUR) and was developed together with the new EU registry on the basis the following modalities:

- (1) Each Party retains its organization designated as its registry administrator to maintain the national registry of that Party and remains responsible for all the obligations of Parties that are to be fulfilled through registries;
- (2) Each Kyoto unit issued by the Parties in such a consolidated system is issued by one of the constituent Parties and continues to carry the Party of origin identifier in its unique serial number;
- (3) Each Party retains its own set of national accounts as required by paragraph 21 of the Annex to Decision 15/CMP.1. Each account within a national registry keeps a unique account number comprising the identifier of the Party and a unique number within the Party where the account is maintained;
- (4) Kyoto transactions continue to be forwarded to and checked by the UNFCCC Independent Transaction Log (ITL), which remains responsible for verifying the accuracy and validity of those transactions;
- (5) The transaction log and registries continue to reconcile their data with each other in order to ensure data consistency and facilitate the automated checks of the ITL;
- (6) The requirements of paragraphs 44 to 48 of the Annex to Decision 13/CMP.1 concerning making non-confidential information accessible to the public would be fulfilled by each Party individually;
- (7) All registries reside on a consolidated IT platform sharing the same infrastructure technologies. The chosen architecture implements modalities to ensure that the consolidated national registries are uniquely identifiable, protected and distinguishable from each other, notably:
 - (a) With regards to the data exchange, each national registry connects to the ITL directly and establishes a distinct and secure communication link through a consolidated communication channel (VPN tunnel);
 - (b) The ITL remains responsible for authenticating the national registries and takes the full and final record of all transactions involving Kyoto units and other administrative processes such that those actions cannot be disputed or repudiated;

- (c) With regards to the data storage, the consolidated platform continues to guarantee that data is kept confidential and protected against unauthorized manipulation;
- (d) The data storage architecture also ensures that the data pertaining to a national registry are distinguishable and uniquely identifiable from the data pertaining to other consolidated national registries;
- (e) In addition, each consolidated national registry keeps a distinct user access entry point (URL) and a distinct set of authorisation and configuration rules.

Following the successful implementation of the CSEUR platform, the 28 national registries concerned were re-certified in June 2012 and switched over to their new national registry on 20 June 2012. During the go-live process, all relevant transaction and holdings data were migrated to the CSEUR platform and the individual connections to and from the ITL were re-established for each Party.

The following changes to the national registry of Liechtenstein have therefore occurred in 2012, as a consequence of the transition to the CSEUR platform:

In accordance to the SIAR Reporting Requirements and Guidance for Registries a high level description for each change should be provided as test plans, test reports and readiness documentation. The required documents are confidential and accessible for assessors only ("documentation annexed to this submission"). Therefore the documents which are mentioned in the below table are not available within this document.

Reporting Item	Description
15/CMP.1 annex II.E paragraph 32.(a) Change of name or contact	We had a change in the national registry. The new register administrator is Heike Summer OFFICE OF THE ENVIRONMENT Department of Environmental Protection Climate Division Dr. Grass-Strasse 12 / Postfach 684 9490 Vaduz

Reporting Item	Description
<p>15/CMP.1 annex II.E paragraph 32.(b)</p> <p>Change regarding cooperation arrangement</p>	<p>The EU Member States who are also Parties to the Kyoto Protocol (25) plus Iceland, Liechtenstein and Norway have decided to operate their registries in a consolidated manner. The Consolidated System of EU registries was certified on 1 June 2012 and went to production on 20 June 2012.</p> <p>A complete description of the consolidated registry was provided in the common readiness documentation and specific readiness documentation for the national registry of EU and all consolidating national registries. This description includes:</p> <ul style="list-style-type: none"> • Readiness questionnaire • Application logging <p>Change management procedure</p> <p>Disaster recovery</p> <ul style="list-style-type: none"> • Manual Intervention • Operational Plan • Roles and responsibilities • Security Plan • Time Validation Plan • Version change Management <p>The documents above are provided as an appendix to this document.</p> <p>A new central service desk was also set up to support the registry administrators of the consolidated system. The new service desk acts as 2nd level of support to the local support provided by the Parties. It also plays a key communication role with the ITL Service Desk with regards notably to connectivity or reconciliation issues.</p>

Reporting Item	Description
<p>15/CMP.1 annex II.E paragraph 32.(c)</p> <p>Change to database structure or the capacity of national registry</p>	<p>In 2012, the EU registry has undergone a major redevelopment with a view to comply with the new requirements of Commission Regulation 920/2010 and Commission Regulation 1193/2011 in addition to implementing the Consolidated System of EU registries (CSEUR).</p> <p>The complete description of the consolidated registry was provided in the common readiness documentation and specific readiness documentation for the national registry of EU and all consolidating national registries. The documentation is annexed to this submission.</p> <p>During certification, the consolidated registry was notably subject to connectivity testing, connectivity reliability testing, distinctness testing and interoperability testing to demonstrate capacity and conformance to the Data Exchange Standard (DES). All tests were executed successfully and lead to successful certification on 1 June 2012.</p>
<p>15/CMP.1 annex II.E paragraph 32.(d)</p> <p>Change regarding conformance to technical standards</p>	<p>The overall change to a Consolidated System of EU Registries triggered changes the registry software and required new conformance testing. The complete description of the consolidated registry was provided in the common readiness documentation and specific readiness documentation for the national registry of EU and all consolidating national registries. The documentation is annexed to this submission.</p> <p>During certification, the consolidated registry was notably subject to connectivity testing, connectivity reliability testing, distinctness testing and interoperability testing to demonstrate capacity and conformance to the DES. All tests were executed successfully and lead to successful certification on 1 June 2012,</p>
<p>15/CMP.1 annex II.E paragraph 32.(e)</p> <p>Change to discrepancies procedures</p>	<p>The overall change to a Consolidated System of EU Registries also triggered changes to discrepancies procedures, as reflected in the updated manual intervention document and the operational plan. The complete description of the consolidated registry was provided in the common readiness documentation and specific readiness documentation for the national registry of EU and all consolidating national registries. The documentation is annexed to this submission..</p>

Reporting Item	Description
<p>15/CMP.1 annex II.E paragraph 32.(f)</p> <p>Change regarding security</p>	<p>The overall change to a Consolidated System of EU Registries also triggered changes to security, as reflected in the updated security plan. The complete description of the consolidated registry was provided in the common readiness documentation and specific readiness documentation for the national registry of EU and all consolidating national registries. The documentation is annexed to this submission.</p>
<p>15/CMP.1 annex II.E paragraph 32.(g)</p> <p>Change to list of publicly available information</p>	<p>Since June 2012 the publicly available information can be accessed via the European Union Transaction Log home page as specified in paragraph 12.4 of this report.</p>
<p>15/CMP.1 annex II.E paragraph 32.(h)</p> <p>Change of Internet address</p>	<p>The new internet address of the LI registry is:</p> <p>https://ets-registry.webgate.ec.europa.eu/euregistry/LI/index.xhtml</p>
<p>15/CMP.1 annex II.E paragraph 32.(i)</p> <p>Change regarding data integrity measures</p>	<p>The overall change to a Consolidated System of EU Registries also triggered changes to data integrity measures, as reflected in the updated disaster recovery plan. The complete description of the consolidated registry was provided in the common readiness documentation and specific readiness documentation for the national registry of EU and all consolidating national registries. The documentation is annexed to this submission.</p>
<p>15/CMP.1 annex II.E paragraph 32.(j)</p> <p>Change regarding test results</p>	<p>On 2 October 2012 a new software release (called V4) including functionalities enabling the auctioning of phase 3 and aviation allowances, a new EU ETS account type (trading account) and a trusted account list went into Production. The trusted account list adds to the set of security measures available in the CSEUR. This measure prevents any transfer from a holding account to an account that is not trusted.</p>
<p>The previous Annual Review recommendations</p> <p>Report IAR/2011/LIE/2/2 for 23/07/2012</p> <p>Ref2.3.4</p> <p>Ref 2.3.6</p> <p>P2.4.1.1</p>	<p>As there was a change in the national registry the description given in Chapter 14.</p> <p>This information is now described in chapter 14.</p> <p>This information is now described in chapter 14.</p> <p>The public information can be found at http://ec.europa.eu/environment/ets/</p>

15 Minimization of Adverse Impacts in Accordance with Article 3, Paragraph 14

The Convention (Art. 4 §8 and §10) and its Kyoto Protocol (Art. 2 §3 and Art. 3 §14) commit Parties to strive to implement climate policies and measures in such a way as to minimize adverse economic, social and environmental impacts on developing countries when responding to climate change. The concrete assessment of potential impacts on developing countries is extremely complex and uncertain, as the effects are often indirect, potentially positive and negative in nature, displaced over time and interacting with other policies, including those applied in developing countries. Liechtenstein has implemented different instruments striving at minimizing potential adverse impacts of its climate change response measures.

Liechtenstein is implementing climate change response measures in all sectors and for different gases. The policies and measures are very much compatible and consistent with those of the European Union in order to avoid trade distortion, non-tariff barriers to trade and to set similar incentives. In accordance with international law, this approach strives at ensuring that Liechtenstein is implementing those climate change response measures, which are least trade distortive and do not create unnecessary barriers to trade.

Tax exemption in Switzerland and consequently also Liechtenstein (tax union) for biofuels is limited to fuels that meet ecological and social criteria. The conditions are set out in such a way that biofuels do not compete with food production and are not causing degradation of rainforests or other valuable ecosystems. The Swiss Centre for Technology Assessment (TA-Swiss) published a study on the assessment of social and environmental impacts of the use of second generation biomass fuels with the following result: "In summary, 2nd generation biofuels allow a more sustainable mobility than both fossil and 1st generation biofuels based on agriculture. Due to the limited availability of both waste feedstocks and cultivation area, however, sustainable bioenergy-based mobility is restricted to clearly less than 8% of individual mobility in Switzerland, if constant mobility and fleet efficiency is assumed. Nevertheless, 2nd generation biofuels may play a relevant complementary part in supplying our future mobility, in particular for long distance transport and aviation where electric mobility is less suitable." (TA-SWISS 2010).

The Swiss Academies of Arts and Sciences have started a project to assess possible conflicts and synergies between the expansion of renewable energy production and land management. Many forms of renewable energy (solar, wind, water, biomass, geothermal) require considerable floor space and lead to changes in land use, ecosystems, and the views of places and landscape. Large-scale use of areas for energy production thus have to be planned considering the maintenance of ecosystem services, protection of biodiversity, or natural sceneries which are important for tourism. A project report is expected at the end of 2010 (at the moment – February 2011 - not published yet).

An assessment of conflicts and synergies between policies and measures to mitigate climate change and biodiversity protection has been made by the biodiversity forum and ProClim in 2008 (SCNAT 2008). While there are several synergies in the area of ecosystem management and agriculture, conflicts exist concerning the use of renewable energies, be it the adverse effects of increased hydroelectricity generation on natural water flows or the impacts of other renewable energy systems on natural landscapes and ecosystems. The report gives recommendations on how to take advantage of synergies and how to detect conflicts in an early stage.

16 Other Information

No other information to be reported.

References

- Acontec 2006:** Greenhouse Gas Inventory Fürstentum Liechtenstein. Berechnungsmethoden. Acontec. Schaan [available in German only].
- Agrammon 2010:** The Swiss ammonia model, Federal Office of the Environment FOEN. Internet version in German, French and English:
<http://www.agrammon.ch/about-agrammon/> [20.12.2012]
Technical description for download (updated periodically):
<http://www.agrammon.ch/technical-description/>
- Agrar 2001:** Forschung Grundlagen für die Düngung im Acker- und Futterbau 2001 Juni 2001, p60.
- Ammann, C., Flechard, C., Leifeld, J., Neftel, A., Fuhrer, J. 2007:** The carbon budget of newly established temperate grassland depends on management intensity. Agriculture, Ecosystems and Environment. Vol 121, Issues 1-2, p. 5-20.
- ARE/SAEFL 2001:** Le paysage sous pression, suite 2. [Landschaft unter Druck, 2. Fortschreibung]. Federal Office for Spatial Development, Bern and Swiss Agency for the Environment, Forests and Landscape, Bern.
<http://www.are.admin.ch/themen/raumplanung/00246/03637/index.html?lang=fr>
[20.12.2012]
- ART 2008:** Uncertainty in agricultural CH₄ and N₂O emissions of Switzerland. Internal documentation by Bretscher, D. and Leifeld, J., Agroscope Reckenholz-Tänikon Research Station, Zürich.
<http://www.environment-switzerland.ch/climatereporting/00545/01913/index.html?lang=en>
[20.12.2012].
- AZV 2011:** Abwasserzweckverband der Gemeinden Liechtensteins. Geschäftsbericht 2010
<http://www.azv.li/info/downloads.html> [17.12.2012].
- Battelle 1994:** Methanfreisetzung bei der Erdgasnutzung in der Schweiz und Vergleich mit anderen Emittenten. Studie im Auftrag des Schweiz. Verein des Gas- und Wasserfaches SVGW. Battelle Ingenieurtechnik, Zürich.
- Braun, M., Hurni, P., Spiess, E. 1994:** Phosphor- und Stickstoffüberschüsse in der Landwirtschaft und Para-Landwirtschaft. Abschätzung für die Schweiz und das Rheineinzugsgebiet der Schweiz unterhalb der Seen. [Surplus de phosphore et d'azote dans l'agriculture et la para-agriculture : estimation pour la Suisse et pour le bassin versant hydrographique suisse du Rhin en aval des lacs]. Schriftenreihe der FAC Liebefeld 18. [in German, with English and French summary]
- Brassel, P., Brändli, U.-B. 1999:** Schweizerisches Landesforstinventar. Ergebnisse der Zweitaufnahme 1993-1995. [Results of the second Swiss national forest inventory 1993-1995]. Eidgenössische Forschungsanstalt für Wald, Schnee und Landschaft, Birmensdorf. Bundesamt für Umwelt, Wald und Landschaft, Bern. Haupt, Bern, Stuttgart, Wien. [available in German, French and Italian]
- Broggi, M.F. 1987:** Der Landschaftswandel im Talraum des Fürstentums Liechtenstein. Diss. Ed: Historischer Verein für das Fürstentum Liechtenstein.
- Burschel, P., Kürsten, E., Larson, B.C. 1993:** Die Rolle von Wald und Forstwirtschaft im Kohlenstoffhaushalt. Eine Betrachtung für Deutschland. Forstliche Forschungsberichte München 126.
- Carbotech 2012:** Swiss Greenhouse Gas Inventory 2010: PFCs, HFCs and SF₆ Emissions, Confidential report for internal use FOEN, 16.1.2012, Basel.
- CH2011 2011:** Swiss Climate Change Scenarios CH2011, published by C2SM, MeteoSwiss, ETH, NCCR Climate, and OcCC, Zurich Switzerland, 88p.

- Covington, W.W. 1981:** Changes in forest floor organic matter and nutrient content following clear cutting in northern hardwoods. *Ecology* 62(1): 41-48.
- De Keizer, C., Ramirez, A., van der Sluijs, J. 2007:** Uncertainty Ranges and Correlations Assumed in Tier 2 Studies of Several European Countries. In: Proceedings of the 2nd International Workshop on Uncertainties in Greenhouse Gas Inventories, 27-28 September 2007, Laxenburg, Austria: 35-39.
<http://www.ibspan.waw.pl/ghg2007/GHG-total.pdf> [20.12.2012]
- EAFV/BFL (eds.) 1988:** Schweizerisches Landesforstinventar. Ergebnisse der Erstaufnahme 1982-1986. Berichte Nr. 305. [Results of the first Swiss national forest inventory 1982-1986]. Eidgenössische Anstalt für das forstliche Versuchswesen.
- EDI/BFS 2009:** Arealstatistik Fürstentum Liechtenstein 1984-1996-2002-2008, Abteilung Raumentwicklung und Nachhaltigkeit, Schlussbericht Teil 1, Methoden, Neuchatel 25.11.2009, http://www.llv.li/pdf-llv-slp-arealstatistik_fl_resultate_84_96_02_08.pdf [20.12.2012]
- EEA 2010:** EMEP/EEA Emission Inventory Guidebook 2009, updated June 2010, Methodology for the calculation of exhaust emissions – SNAPs 070100-070500, NFRs 1A3bi-iv Passenger cars, light-duty trucks, heavy-duty vehicles including buses and motor cycles. <http://www.emisia.com/copert/> [20.12.2012]
- Eicher and Pauli 2006:** “Review of the National Greenhouse Gas Inventory, Categories Energy and Industrial Processes” Final Report 27 April 2006. The report may be downloaded from
<http://www.bafu.admin.ch/climatereporting/00545/01913/index.html?lang=en> [12.12.2012]
- EMIS 2012/(NFR-Code):** Comments to EMIS database. Internal documents. Federal Office of the Environment, Bern.
- EMPA 1999:** Written communication from Dr. H.W. Jäckle (EMPA, Dübendorf) to Andreas Liechti (FOEN, Bern), 09.03.1999.
www.environment-switzerland.ch/climatereporting/00545/01913/index.html?lang=en [15.11.2012]
- FAL/RAC 2001:** Grundlagen für die Düngung im Acker- und Futterbau 2001. Eidgenössische Forschungsanstalt für Agrarökologie und Landbau / Eidgenössische Forschungsanstalt für Pflanzenbau. Agrarforschung, June 2001, Zürich-Reckenholz / Nyon [also available in French]. <http://www.agroscope.admin.ch/shop/00015/00057/index.html?lang=de> [20.12.2012]
- FCCC 2003:** Guidelines for the Preparation of National Communications by Parties Included in Annex I to the Convention. Part I: UNFCCC Reporting Guidelines on Annual Inventories, FCCC/CP/2002/8.
- FCCC 2006:** Annotated outline of the National Inventory Report including reporting elements under the Kyoto Protocol. FCCC/SBSTA/2006/9.
- FCCC 2012:** Potential Problems and Further Questions from the ERT formulated in the course of the 2012 review of the greenhouse gas inventories of Liechtenstein submitted in 2012. For the ERT, Bonn, Germany, 29 September 2012 Ms. Kristina Saarinen, Mr. Sohyang Lee, Lead Reviewers
- FCCC/ARR 2007:** Report of the individual review of the greenhouse gas inventory of Liechtenstein submitted in 2006 (FCCC/ARR/2006/LIE), 18.11.2007
<http://unfccc.int/resource/docs/2007/arr/lie.pdf> [12.12.2012]
- FCCC/ARR 2009:** Report of the individual review of the annual submission of Liechtenstein submitted in 2009 (FCCC/ARR/2008/LIE), 1.4.2009
http://unfccc.int/national_reports/annex_i_ghg_inventories/inventory_review_reports/items/4400.php [12.12.2012]

- FCCC/ARR 2010:** Report of the individual review of the annual submission of Liechtenstein submitted in 2010 (FCCC/ARR/2009/LIE), 19.3.2010
http://unfccc.int/national_reports/annex_i_ghg_inventories/inventory_review_reports/items/4704.php [12.12.2012]
- FCCC/ARR 2010a:** Report of the individual review of the annual submission of Liechtenstein submitted in 2010, (FCCC/ARR/2010/LIE) UNFCCC 7.12.2010
http://unfccc.int/national_reports/annex_i_ghg_inventories/inventory_review_reports/items/5687.php [12.12.2012]
- FCCC/ARR 2011:** Report of the individual review of the annual submission of Liechtenstein submitted in 2011 (FCCC/ARR/2011/LIE), 13.6.2012
http://unfccc.int/documentation/documents/advanced_search/items/6911.php?preref=600006953 [14.11.2012]
- FCCC/ARR 2012:** Report of the individual review of the annual submission of Liechtenstein submitted in 2012 (FCCC/ARR/2012/LIE),
http://unfccc.int/documentation/documents/advanced_search/items/6911.php?preref=600006953 [14.11.2012]
- FCCC/IRR 2007:** Report of the review of the initial report of Liechtenstein.
FCCC/IRR/2007/LIE 13 December 2007.
<http://unfccc.int/resource/docs/2007/irr/lie.pdf> [12.12.2012]
- Flisch, R., Sinaj, S., Charles, R., Richner, W. 2009:** Grundlagen für die Düngung im Acker- und Futterbau 2009. Forschungsanstalt Agroscope Changins-Wädenswil ACW und Agroscope Reckenholz-Tänikon ART, Agrarforschung 16 (2).
- FOEN 2006a:** Switzerland's Greenhouse Gas Inventory 1990-2004. National Inventory Report 2006. Submission to the United Nations Framework Convention on Climate Change. Swiss Federal Office for the Environment, Bern, 10 November 2006.
- FOEN 2006b:** Definition der Kombinationskategorien (CC) für die LULUCF-Berichterstattung auf der Basis der AREA-Landnutzungs- und Landbedeckungskategorien. Internes Dokument, Version vom 02.03.2006. [Definition of combination categories (CC) for LULUCF reporting based on AREA land-use/land-cover categories. Internal document. 02.03.2006.] Federal Office for the Environment, Bern. [in German]
<http://www.bafu.admin.ch/climatereporting/00545/01913/index.html?lang=en> [20.12.2012]
- FOEN 2007:** Switzerland's Greenhouse Gas Inventory 1990-2005. National Inventory Report 2007. Submission to the United Nations Framework Convention on Climate Change. Swiss Federal Office for the Environment, Bern, 13 April 2007.
- FOEN 2008:** Switzerland's Greenhouse Gas Inventory 1990-2006. National Inventory Report 2008. Submission under the United Nations Framework Convention on Climate Change and under the Kyoto Protocol. Swiss Federal Office for the Environment, Bern, 15 April 2008.
www.bafu.admin.ch/climatereporting/00545/06033/index.html?lang=en [20.12.2012]
- FOEN 2009:** Switzerland's Greenhouse Gas Inventory 1990-2007. National Inventory Report 2007. Submission under the United Nations Framework Convention on Climate Change and under the Kyoto Protocol. Swiss Federal Office for the Environment, Bern, 15 April 2009.
<http://www.bafu.admin.ch/climatereporting/00545/07651/index.html?lang=en> [20.12.2012]
- FOEN 2010:** Switzerland's Greenhouse Gas Inventory 1990-2008. National Inventory Report 2008. Submission under the United Nations Framework Convention on Climate Change and under the Kyoto Protocol. Swiss Federal Office for the Environment, Bern, 15 April 2010.
<http://www.bafu.admin.ch/climatereporting/00545/10195/index.html?lang=en> [15.11.2012]

- FOEN 2010d:** Deforestations in Switzerland as reported under the Kyoto Protocol Art. 3.3. Forest Division, Federal Office for the Environment, Bern. <http://www.environment-switzerland.ch/climatereporting/00545/01913/index.html?lang=en>
- FOEN 2012:** Switzerland's Greenhouse Gas Inventory 1990-2010. National Inventory Report 2010. Submission under the United Nations Framework Convention on Climate Change and under the Kyoto Protocol. Swiss Federal Office for the Environment, Bern, 15 April 2012.
<http://www.bafu.admin.ch/climatereporting/00545/11894/index.html?lang=en> [15.11.2012]
- GHFL 2007:** Letter from Genossenschaft für Heizöl-Lagerhaltung im Fürstentum Liechtenstein (GHFL; Cooperative society for the storage of gas oil in the Principality of Liechtenstein; Ms. Helga Faritsch) to Mr. J. Beckbissinger/Acontec AG, 20.09.2007.
- GHFL 2008:** Telephone from Genossenschaft für Heizöl-Lagerhaltung im Fürstentum Liechtenstein (GHFL; Cooperative society for the storage of gas oil in the Principality of Liechtenstein; Ms. Helga Faritsch) to Mr. J. Beckbissinger/Acontec AG, 15.07.2008.
- Government 1980:** Währungsvertrag zwischen der Schweizerischen Eidgenossenschaft und dem Fürstentum Liechtenstein. 0.951.951.4. Vaduz/Bern.
<http://www.admin.ch/ch/d/sr/i9/0.951.951.4.de.pdf> [12.12.2012]
- Government 1986:** Government of the Principality of Liechtenstein. Luftreinhaltegesetz (LRG) 20. November 1985.
- Government 2003:** Government of the Principality of Liechtenstein. Luftreinhaltegesetz (LRG) vom 18. Dezember 2003.
- Hadorn, R., Wenk, C. 1996:** Effect of different sources of dietary fibre on nutrient and energy utilization in broilers. 2. Energy and N-balance as well as whole body composition. Archiv für Geflügelkunde 60: 22-29.
- IBK 2007:** Auswirkungen des Klimawandels und mögliche Anpassungsstrategien, AWEL Zürich and Commission for Environment (Platform climate protection and energy) of the International Bodensee Conference, Zürich December 2007 (available in German only). Download in PDF format from:
http://www.bodenseekonferenz.org/31786/Handlungsfelder/Umwelt/Plattform-Klimaschutz-und-Energie/index_v2.aspx [20.12.2012]
- INFRAS 2004:** Luftschadstoff-Emissionen des Strassenverkehrs 1980-2030. Bundesamt für Umwelt, Wald und Landschaft / INFRAS. Schriftenreihe Umwelt Nr. 355, Bern (available in German only). Download in PDF format from <http://www.hbefa.net/> [13.12.2012]
- INFRAS 2008:** Treibstoffverbrauch und Schadstoffemissionen des Offroad-Sektors. Studie für die Jahre 1980–2020. Umwelt-Wissen Nr. 0828. INFRAS im Auftrag des Bundesamts für Umwelt, Bern.
www.bafu.admin.ch/publikationen/publikation/01003/index.html?lang=de [12.12.2012]
- INFRAS 2010:** The Handbook Emission Factors for Road Transport (HBEFA), version 3.1 (MS AccessXP runtime application and report). INFRAS in cooperation with further editors: FOEN/Switzerland; Umweltbundesamt Dessau/Germany; Umweltbundesamt Wien/Austria; Swedish Road Administration, ADEME/France; SFT/Norway. Bern. 30.01.2010. <http://www.hbefa.net/e/index.html> [13.12.2012]
- INFRAS 2011 (forthcoming):** Handbuch Emissionsfaktoren des Strassenverkehrs 3.1. Dokumentation. Bern. <http://www.hbefa.net/e/index.html> [20.12.2012]
- Intertek 2008:** Bestimmung der Heizwerte und CO₂-Emissionsfaktoren von Brenn- und Treibstoffen. Untersuchungsbericht Nr. 170375. Intertek Caleb Brett im Auftrag des Bundesamts für Umwelt BAFU. FOEN internal document. Schlieren/Bern.
<http://www.environment-switzerland.ch/climatereporting/00545/01913/index.html?lang=en> [15.11.2012]

- IPCC 1996:** Greenhouse Gas Inventory Reference Manual. IPCC Guidelines for National Greenhouse Gas Inventories. Volume 1, Annex 1, Managing Uncertainties, IPCC WG I Technical Support Unit, Bracknell, U.K.
- IPCC 1997a:** Greenhouse Gas Inventory Reference Manual. Revised 1996 IPCC Guidelines for National Greenhouse Gas Inventories. Volume 1, Reporting Instructions, Intergovernmental Panel on Climate Change a.o., IPCC WG I Technical Support Unit, Bracknell, U.K.
<http://www.ipcc-nggip.iges.or.jp/public/gl/invs1.htm> [12.12.2012]
- IPCC 1997b:** Greenhouse Gas Inventory Reference Manual, Revised 1996 IPCC Guidelines for National Greenhouse Gas Inventories. Volume 2, Workbook, Intergovernmental Panel on Climate Change a.o., IPCC WG I Technical Support Unit, Bracknell, U.K.
<http://www.ipcc-nggip.iges.or.jp/public/gl/invs1.htm> [12.12.2012]
- IPCC 1997c:** Greenhouse Gas Inventory Reference Manual, Revised 1996 IPCC Guidelines for National Greenhouse Gas Inventories. Volume 3, Reference Manual, Intergovernmental Panel on Climate Change a.o., IPCC WG I Technical Support Unit, Bracknell, U.K.
<http://www.ipcc-nggip.iges.or.jp/public/gl/invs1.htm> [12.12.2012]
- IPCC 2000:** Good Practice Guidance and Uncertainty Management in National Greenhouse Gas Inventories (IPCC GPG)
<http://www.ipcc-nggip.iges.or.jp/public/gp/gpgaum.htm> [12.12.2012]
- IPCC 2003:** Good Practice Guidance for Land Use, Land-Use Change and Forestry (IPCC GPG LULUCF).
<http://www.ipcc-nggip.iges.or.jp/public/gp/lulucf/gp/lulucf.htm> [12.12.2012]
- IPCC 2006:** Guidelines for National Greenhouse Gas Inventories. Prepared by the National Greenhouse Gas Inventories Programme, Eggleston, H.S., Buendia, L., Miwa, K., Ngara, T. and Tanabe K. <http://www.ipcc-nggip.iges.or.jp/public/2006gl/index.html> [13.12.2012]
- IPCC 2009:** Annotated outline of the National Inventory Report including reporting elements under the Kyoto Protocol
http://unfccc.int/files/national_reports/annex_i_ghg_inventories/reporting_requirements/application/pdf/annotated_nir_outline.pdf [12.12.2012]
- Kaufmann, E. 2001:** Estimation of standing timber, growth and cut. In: Brassel, P., Lischke, H. (eds.): Swiss National Forest Inventory: Methods and Models of the Second Assessment. Swiss Federal Research Institute WSL, Birmensdorf: 162-196.
- Leifeld, J., Bassin, S., Fuhrer, J. 2003:** Carbon stocks and carbon sequestration potentials in agricultural soils in Switzerland. Schriftenreihe der FAL 44. Zürich-Reckenholz.
- Leifeld, J., Bassin, S., Fuhrer, J. 2005:** Carbon stocks in Swiss agricultural soils predicted by land-use, soil characteristics, and altitude. Agriculture, Ecosystems & Environment 105 (1/2): 255-266.
- LGV 2012:** Annual Report of Liechtenstein's Gas Utility (Geschäftsbericht 2012 der Liechtensteinischen Gasversorgung; in German).
<http://www.lgv.li/content.aspx?auswahl=2928&mid=2928> [15.11.2012]
- LKW 2010:** Email from Jürg Tinner, Liechtensteinische Kraftwerke to Acontec AG on 11 October 2010 (in German).
- Menzi, H., Frick, R., Kaufmann, R. 1997:** Ammoniak-Emissionen in der Schweiz: Ausmass und technische Beurteilung des Reduktionspotenzials. [Emissions d'ammoniac en Suisse: amplitude et évaluation technique du potentiel de réduction]. Schriftenreihe der FAL 26. Zürich-Reckenholz. [in German, with English and French summary]
- Moeri, A.C. 2007.:** Kohlenstoffvorräte in Schweizer Waldböden mit besonderer Berücksichtigung der organischen Auflage. Diplomarbeit bei der Eidgenössischen

Forschungsanstalt für Wald, Schnee und Landschaft (WSL). Geographisches Institut der Universität Zürich.

<http://www.bafu.admin.ch/climatereporting/00545/01913/index.html?lang=en&lang=en>
[20.12.2012]

- Nigsch, N. 2012:** No forest fires in Liechtenstein since 1985. Written communication from Norman Nigsch (Amt für Wald, Natur und Landschaft) to Patrick Insinna (Amt für Umweltschutz, Vaduz).
- North, N., Kljun, N., Kasser, F., Heldstab, J., Maibach, M., Reutimann, J., Guyer, M. 2007:** Klimaänderung in der Schweiz. Indikatoren zu Ursachen, Auswirkungen, Massnahmen. Umweltzustand Nr. 0728. Bundesamt für Umwelt, Bern. 77 pp.
<http://www.bafu.admin.ch/publikationen/publikation/00065/index.html?lang=de>
[24.10.201200]
- OA 2002:** Annual census on livestock numbers in agriculture. Data until 2002 edited by the Office of Agriculture (Landwirtschaftsamt). Data after 2002 edited by OFIVA. Published in „Statistisches Jahrbuch, Kap. 5.1 Land- und Forstwirtschaft“. Vaduz
http://www.llv.li/pdf-llv-avw-statistik-kapitel_5_wirtschaftsbereiche [20.12.2012]
- OcCC 2007:** Climate Change and Switzerland 2050. Expected Impacts on Environment, Society and Economy. The Advisory Body on Climate Change, Bern.
<http://www.proclim.ch/products/ch2050/ch2050-report.html> [09.01.2012]
- OcCC 2008:** Das Klima ändert – was nun? Der neue UN-Klimabericht (IPCC 2007) und die wichtigsten Ergebnisse aus Sicht der Schweiz. The Advisory Body on Climate Change, Bern. <http://www.proclim.ch/4dcgi/occc/de/Report?524>[24.10.2012]
- OEA 2000:** Publikationen zur Liechtensteinischen Volkszählung 2000, Band 4: Haushalte und Familien. Amt für Volkswirtschaft. Vaduz.
http://www.llv.li/pdf-llv-avw-statistik-haushalte_und_familien_teil1-analyse [20.12.2012]
- OEA 2012:** Energiestrategie 2020. Regierung des Fürstentums Liechtenstein, Resort Wirtschaft, Vaduz.
http://www.regierung.li/fileadmin/dateien/Downloads/Energiestrategie_Langfassung.pdf
[19.03.2013]
- OEA 2008:** Energy Efficiency Act: Gesetz über die Förderung von Energieeffizienz und der erneuerbaren Energien. Government of Liechtenstein. Liechtenstein Law Gazette. Year 2008, No. 116. Issue on 20. May 2008. Vaduz.
http://www.gesetze.li/get_pdf.jsp?PDF=2008116.pdf [12.12.2012]
- OEP 2002:** Strassenverkehrsemissionen im Fürstentum Liechtenstein 1990, 2000, 2010, Schlussbericht. Office of Environmental Protection (OEP) / INFRAS; Bern/Vaduz, 18. Januar 2002 [available in German only].
- OEP 2006:** Liechtenstein's Greenhouse Gas Inventory 1990–2004. National Inventory Report 2006. Submission of 22 December 2006 to the Framework Convention on Climate Change (UNFCCC). Office of Environmental Protection (OEP), Vaduz.
- OEP 2006a:** Liechtenstein's Initial Report under Article 7, paragraph 4 of the Kyoto Protocol. Office of Environmental Protection (OEP), Vaduz, 22 December 2006.
- OEP 2006b:** Heizölverbrauch 1990 Fürstentum Liechtenstein. Office of Environmental Protection (OEP) / Acontec; Vaduz/Schaan [available in German only].
- OEP 2006c:** Treibstoffabsatz 1990 FL. Fürstentum Liechtenstein. Office of Environmental Protection (OEP) / Acontec; Vaduz/Schaan [available in German only].
- OEP 2006d:** Map of Liechtenstein showing altitude class and soil types, Vaduz.
- OEP 2007:** Liechtenstein's Greenhouse Gas Inventory 1990–2005. CRF Tables and National Inventory Report 2006. Submission of 10 May 2007 to the Framework Convention on Climate Change (UNFCCC). Office of Environmental Protection (OEP), Vaduz.

- OEP 2007a:** Liechtenstein's Greenhouse Gas Inventory 1990-2004. In-Country Review of the Initial Report and the National Inventory Report, 11-15 June 2007. Response by Party to potential problems identified by the UNFCCC Expert Review Team (ERT). Revised version 9 August 2007. Office of Environmental Protection (OEP), Vaduz.
- OEP 2007b:** Liechtenstein's Initial Report under Article 7, paragraph 4 of the Kyoto Protocol. Corrigendum, 19 September 2007. Office of Environmental Protection (OEP), Vaduz.
- OEP 2007c:** Email by Helmut Kindle/OEP to Ernst Basler + Partner on July 2, 2007.
- OEP 2007d:** Nationale Klimaschutzstrategie für das Fürstentum Liechtenstein. Vaduz. http://www.llv.li/pdf-llv-aus-nationale_klimaschutzstrategie_07.pdf [12.12.2012]
- OEP 2007e:** Action Plan Air. Massnahmenplan Luft des Fürstentums Liechtenstein. Vaduz. http://www.llv.li/pdf-llv-aus-massnahmenplan_luft_200709.pdf [12.12.2012]
- OEP 2008:** Liechtenstein's Greenhouse Gas Inventory 1990–2006. CRF Tables and National Inventory Report 2008. Submission of 29 February 2008 under the United Nations Framework Convention on Climate Change and under the Kyoto Protocol. Office of Environmental Protection (OEP), Vaduz
- OEP 2008a:** Expert estimates. Several personal communications from experts within OEP:
- E-mail 4 July 2008 from A. Gstöhl to J. Beckbissinger: Daten Kompost, Klärgas, Treibstoffabsatz (data on composting, sewage gas, fuel consumption)
 - E-mail 7 July 2008 from P. Insinna to J. Beckbissinger: Treibstoffabsatz 2007 (fuel consumption 2007)
 - E-mail 21 August 2008 from A. Gstöhl to J. Beckbissinger: Abfalldaten: KVA und Datenkorrektur Grüngut (data on waste, correction of composting statistics)
- OEP 2008b:** Emissions Trading Act (EHG). Liechtenstein Law Gazette. Year 2008, No. 10, issue on 15th January 2008. Vaduz. http://www.llv.li/pdf-llv-aus-emissionshandelsgesetz_final_en.pdf [12.12.2012]
- OEP 2008c:** CO₂-Act: Gesetz über die Erhebung einer CO₂-Abgabe auf fossilen Energieträgern (CO₂-Gesetz). Liechtenstein Law Gazette. Year 2008, No. 19. Issue on 01. February 2008. Vaduz. http://www.gesetze.li/get_pdf.jsp?PDF=2010019.pdf. [12.12.2012]
- OEP 2008d:** Environmental Protection Act. Liechtenstein Law Gazette. Year 2008, No. 199. Issue on 28. July 2008. Vaduz. http://www.gesetze.li/get_pdf.jsp?PDF=2008199.pdf. [12.12.2012]
- OEP 2009a:** Liechtenstein's Greenhouse Gas Inventory 1990–2007. CRF Tables and National Inventory Report 2009. Submission of 2 April 2009 under the United Nations Framework Convention on Climate Change and under the Kyoto Protocol. Office of Environmental Protection (OEP), Vaduz.
- OEP 2009b:** Time series for alkylate gasoline data. E-mail communication (data file attached: Offroad_Emissionen LI.xls) from P. Insinna (OEP) to J. Heldstab (INFRAS) on 22.10.2009.
- OEP 2009c:** E-mail 2 September 2009 from P. Insinna to J. Beckbissinger: Menge Siedlungsabfall im 2008 (data on municipal solid waste 2008)
- OEP 2009d:** E-mail 7 July 2009 from P. Insinna to J. Beckbissinger: Daten Inventar (data on composting, sewage gas, fuel consumption)
- OEP 2010b:** Liechtenstein's Greenhouse Gas Inventory 1990–2008. CRF Tables and National Inventory Report 2010. Submission of 11 of March 2010 under the United Nations Framework Convention on Climate Change and under the Kyoto Protocol. Office of Environmental Protection (OEP), Vaduz

- OEP 2010c:** Liechtenstein's Greenhouse Gas Inventory 1990–2008. Updated KP-LULUCF Tables of October 2010 due to the review process (Saturday Paper). Submission of 15 of October 2010 under the United Nations Framework Convention on Climate Change and under the Kyoto Protocol. Office of Environmental Protection (OEP), Vaduz
- OEP 2011a:** Liechtenstein's Greenhouse Gas Inventory 1990–2009. CRF Tables and National Inventory Report 2010. Submission of 11 of March 2011 under the United Nations Framework Convention on Climate Change and under the Kyoto Protocol. Office of Environmental Protection (OEP), Vaduz.
- OEP 2011b:** Recalculation of the agricultural greenhouse gas emissions of Liechtenstein, original title: „Neuberechnung der landwirtschaftlichen Treibhausgasemissionen von Liechtenstein“, Daniel Bretscher, Zürich 23.12.2011, by order and for account of OEP. A detailed MS-EXCEL background calculation sheet is part of this recalculation
- OEP 2011c:** Results of census about diesel and gasoline sales. Email communication (data file attached: Offizielle Daten Treibstoffhebungen AFU.xls) from P. Insinna (AFU) to J. Beckbissinger (Acontec) on 10.10.2011
- OEP 2012:** Liechtenstein's submission under the UNECE Convention on Long-range Transboundary Air Pollution (CLRTAP), Inventory 1990–2010. Office of Environmental Protection (OEP), Vaduz, 2012
<http://www.ceip.at/submissions-under-clrtap/> [20.12.2012]
- OEP 2012a:** E-mail from A. Gstohel (OEP) to J. Heldstab (INFRAS) confirming that the share of backyard composting assumed so far is the most precise estimate available. Vaduz. 12.01.2012.
- OEP 2012b:** Liechtenstein's Greenhouse Gas Inventory 1990–2010. CRF Tables and National Inventory Report 2011. Submission of 11 of March 2012 under the United Nations Framework Convention on Climate Change and under the Kyoto Protocol. Office of Environmental Protection (OEP), Vaduz.
- OEP 2012c:** Results of census about diesel and gasoline sales. E-Mail communication from P. Insinna (OEP) to J. Beckbissinger (Acontec) on 16.08.2012
- OE 2013:** Liechtenstein's submission under the UNECE Convention on Long-range Transboundary Air Pollution (CLRTAP), Inventory 1990–2011. Office of Environmental Protection (OEP), Vaduz, 2013
<http://www.ceip.at/overview-of-submissions-under-clrtap/> [20.12.2012]
- OFIVA/OA 2011:** Tierbestand, Erhebungen des Tierseuchenfonds für das Jahr 2010; Amt für Lebensmittelkontrolle und Veterinärwesen in Zusammenarbeit mit Landwirtschaftsamt, Vaduz, 2011.
For the previous years 2002-2009 there are corresponding statistics available by the same Offices Office of Food Inspection and Veterinary Affairs, OFIVA, and the Office of Agriculture, OA. All data are published in "Statistisches Jahrbuch, Kap 5.1 Land- und Forstwirtschaft". Vaduz
http://www.llv.li/llv-as-statistisches_jahrbuch [23.11.2012]
- OFIVA/OA 2012:** Tierbestand, Erhebungen des Tierseuchenfonds für das Jahr 2011; Amt für Lebensmittelkontrolle und Veterinärwesen in Zusammenarbeit mit Landwirtschaftsamt, Vaduz, 2012.
- OS 2011b:** Beschäftigungsstatistik 2010 Fürstentum Liechtenstein. Office of Statistics (Amt für Statistik), Vaduz 2011.
http://www.llv.li/il-pdf-llv-as-beschaefigungsstatistik_2010_vers.2 [12.12.2012]
- OS 2011e:** Bevölkerungsstatistik 31. Dezember 2011. Fürstentum Liechtenstein. Office of Statistics, Vaduz 2011. <http://www.llv.li/amtstellen/llv-as-publikationsarchiv/llv-as-publikationen-bevoelkerung.htm> [20.12.2012]

- OS 2012a:** Energiestatistik 2011 Fürstentum Liechtenstein. Office of Statistics (Amt für Statistik), Vaduz 2012.
<http://www.llv.li/amtstellen/llv-as-publikationsarchiv/llv-as-publikationen-energie.htm>
[16.11.2012]
- OS 2012b:** Beschäftigungsstatistik 2011 Fürstentum Liechtenstein. Office of Statistics (Amt für Statistik), Vaduz 2012.
http://www.llv.li/llv-as-beschaefigte_und_arbeitsplaetze [03.12.2012]
- OS 2012c:** Statistisches Jahrbuch Liechtensteins 2012. Fürstentum Liechtenstein. Office of Statistics, Vaduz 2012.
http://www.llv.li/llv-as-statistisches_jahrbuch [03.12.2012]
- OS 2012d:** Bevölkerungsstatistik. 31. Dezember 2011. Fürstentum Liechtenstein. Office of Statistics, Vaduz 2012.
<http://www.llv.li/llv-as-bevoelkerung> [03.12.2012]
- Ostluft 2011:** Luftqualität in der Ostschweiz und in Liechtenstein 2009
<http://www.ostluft.ch/index.php?id=78> [12.12.2012]
- Perruchoud, D., Walthert, L., Zimmermann, S., Lüscher, P. 2000:** Contemporary carbon stocks of mineral forest soils in the Swiss Alps. *Biogeochemistry* 50: 111-136.
<http://www.springerlink.com/content/h3738727514800r3/> [20.12.2012]
- Prasuhn, V., Braun, M. 1994:** Abschätzung der Phosphor- und Stickstoffverluste aus diffusen Quellen in die Gewässer des Kantons Bern. [Estimation des pertes en phosphore et en azote dans les eaux du canton de Berne à partir de sources diffuses]. Schriftenreihe der FAC Liebefeld 17. [in German, with English and French summary]
- Prasuhn, V., Mohni, R. 2003:** GIS-gestützte Abschätzung der Phosphor- und Stickstoffeinträge aus diffusen Quellen in die Gewässer des Kantons Bern. FAL, interner Bericht z.H. Amt für Gewässerschutz und Abfallwirtschaft, Kanton Bern/Zürich-Reckenholz.
<http://www.agroscope.admin.ch/gewaesserschutz-stoffhaushalt/04047/04055/index.html>
[20.12.2012]
- RAP 1999:** Fütterungsempfehlungen und Nährwerttabellen für Wiederkäuer. Landwirtschaftliche Lehrmittelzentrale, Zollikofen.
online version available
<http://www.agroscope.admin.ch/publikationen/einzelpublikation/index.html?lang=de&aid=13952&pid=17716> [20.12.2012]
- Rhein Helikopter 2006:** Written communication from Manfred Nipp to Jürgen Beckbissinger. Acontec on 19 September 2006, Subject: Kerosinverbrauch 1994.
- Rhein Helikopter 2007:** e-mail communication (kerosene consumption in data file attached: "Flugminuten Acontec.xls") from Rhein Helikopter AG to J. Beckbissinger (Acontec) on 16 February 2007. Subsequent telephone communication Ms Riedi (Rhein Helikopter AG) with J. Beckbissinger (Acontec) to complete the data with the share of domestic/ international on 14 March 2007.
- Rhein Helikopter 2008:** e-mail communication (kerosene consumption in data file attached: "Flugminuten Acontec.xls") from Rhein Helikopter AG to J. Beckbissinger (Acontec) on 12 August 2008.
- Rhein Helikopter 2009:** e-mail and telephone communication from Rotex Helicopter (Zinsmeister) and Rhein Helikopter AG (Forrer) respectively, to J. Beckbissinger (Acontec) on 3 August 2009.
- Rhein Helikopter 2010:** e-mail communication from Rotex Helicopter (Zinsmeister) and Rhein Helikopter AG (Forrer) respectively, to J. Beckbissinger (Acontec) on 23 August 2010.

- Rhein Helikopter 2011:** e-mail communication from Rotex Helicopter (Zinsmeister) and Rhein Helikopter AG (Forrer) respectively, to J. Beckbissinger (Acontec) on 11. Mai 2011.
- Rhein Helikopter 2012:** e-mail communication from Rotex Helicopter (Zinsmeister) and Rhein Helikopter AG (Forrer) respectively, to J. Beckbissinger (Acontec) on 09. Mai 2012.
- Rihm, B., et. al. 2010:** Waldflächen-Veränderungen im Rahmen des Kyoto-Protokolls – Abklärungen betreffend AREA-Daten. [Analysis of forest-land changes in the AREA survey.] In preparation.
- Rusch, S., Hagedorn, F., Zimmermann, S., Lüscher, P. 2009:** Bodenkohlenstoff nach Windwurf – eine CO₂-Quelle? [Soil carbon after wind throw – a source of CO₂?]. Report on behalf of the Federal Office for the Environment, 36 p. [German]
<http://www.environment-switzerland.ch/climatereporting/00545/01913/index.html?lang=en>
[20.12.2012]
- Rytec 2010:** National Greenhouse Gas Inventory of Switzerland, Review of the “waste sector”. Rytec - Waste Technology + Energy Concepts. Final report, Muensingen/Switzerland, 7 October 2010.
- SAEFL 2000a:** Handbuch Emissionsfaktoren für stationäre Quellen. Ausgabe 2000. Bundesamt für Umwelt, Wald und Landschaft, Reihe Vollzug Umwelt, Bern.
www.bafu.admin.ch/luft/00596/00597/00605/index.html?lang=en [12.12.2012]
- SAEFL 2005:** Arbeitsblatt Emissionsfaktoren Feuerungen. Stand Oktober 2005. Swiss Agency for the Environment, Forests and Landscape.
<http://www.bafu.admin.ch/climatereporting/00545/01913/index.html?lang=en>
[13.12.2012], [in German]
- SAEFL 2005b:** Wald und Holz. Jahrbuch 2005 [La forêt et le bois. Annuaire 2005]. Schriftenreihe Umwelt Nr. 386. Swiss Agency for the Environment, Forests and Landscape, Bern. [in German and French]
<http://www.bafu.admin.ch/climatereporting/00545/01913/index.html?lang=en> [20.12.2012]
- SBV 2006:** Schweizerischer Bauernverband (Swiss Farmer's Union). Gesamtübersicht über die Nahrungsmittelversorgung der Schweiz, 1980 - 2006. http://www.sbv-usb.ch/fileadmin/user_upload/bauernverband/Statistik/Ernaehrungsbilanz/se_0605.pdf
[20.12.2012]
- SBV 2009:** Statistiques et évaluations concernant l'agriculture et l'alimentation, 2007. [Statistische Erhebungen und Schätzungen über Landwirtschaft und Ernährung, 2007]. Swiss Farmers Union, Brugg. [available in German and French]
- Schmid, M., et al. 2000:** Lachgasemissionen aus der Schweizer Landwirtschaft. [Emissions de protoxyde d'azote de l'agriculture Suisse]. Schriftenreihe der FAL 33. Zürich-Reckenholz.
- SCNAT 2008:** Biodiversität und Klima – Konflikte und Synergien im Massnahmenbereich Ein Positionspapier der Akademie der Naturwissenschaften Schweiz (SCNAT), ISBN: 978-3-907630-31-0. Bern.
in German: http://www.biodiversity.ch/downloads/Bio_Klima_deutsch_leicht.pdf
in French: http://www.biodiversity.ch/downloads/Bio_Klima_franz_leicht.pdf [20.12.2012]
- SFOE 2001:** Schweizerische Gesamtenergiestatistik 2000. Statistique globale suisse de l'énergie 2000. Bundesamt für Energie, Bern. [in German and French]
http://www.bfe.admin.ch/themen/00526/00541/00542/00631/index.html?lang=de&dossier_id=00763) [15.11.2012]
- SFOE 2002:** Swiss Federal Office for Energy: Ökobilanz Klärgasverstromung. Projekt 41863 Verfügung 83688. Bern, November 2002.
<http://www.naturemade.ch/Dokumente/oekobilanzen/KI%C3%A4rgasverstromung%2017.11.02.pdf> [20.12.2012]

- SFOE 2011:** Schweizerische Gesamtenergiestatistik 2010. Statistique globale suisse de l'énergie 2010. Swiss Federal Office of Energy, Bern. [German and French]
http://www.bfe.admin.ch/themen/00526/00541/00542/00631/index.html?lang=de&dossier_id=00763 [12.12.2012]
- SFOE 2012:** Schweizerische Gesamtenergiestatistik 2011. Statistique globale suisse de l'énergie 2011. Swiss Federal Office of Energy, Bern. [German and French]
http://www.bfe.admin.ch/themen/00526/00541/00542/00631/index.html?lang=de&dossier_id=00763 [10.12.2012]
- SFSO 2006a:** Arealstatistik 2004/09 - Kategorienkatalog. Bodenbedeckung, Bodennutzung. Sektion Geoinformatik.
<http://www.bafu.admin.ch/climatereporting/00545/01913/index.html?lang=en>
[09.01.2012]
- SFSO 2006b:** Swiss Federal Statistical Office. Wood production in Switzerland 1975-2005.
<http://www.agr.bfs.admin.ch> [official text in German, English, French and Italian]
[20.12.2012]
- SFSO 2012a:** Haushalte nach Haushalttyp. Swiss Federal Statistical Office
<http://www.bfs.admin.ch/bfs/portal/de/index/themen/01/04/blank/key/haushaltstypen.html>
[3.12.2012].
- SFSO 2012b:** Erwerbstätigkeit und Arbeitszeit. Swiss Federal Statistical Office
<http://www.bfs.admin.ch/bfs/portal/de/index/themen/03/02/blank/data/02.html> [3.12.2012].
- SFSO 2012c:** Fahrzeuge Strasse – Bestand. Swiss Federal Statistical Office
http://www.bfs.admin.ch/bfs/portal/de/index/themen/11/03/blank/key/fahrzeuge_strasse/bestand.html [3.12.2012].
- SFSO 2012d:** Bevölkerung – Die wichtigsten Zahlen. Swiss Federal Statistical Office
<http://www.bfs.admin.ch/bfs/portal/de/index/themen/01/01/key.html> [3.12.2012].
- SIAR 2011:** Standard Independent Assessment Report, UNFCCC, 1.8.2011,
http://unfccc.int/kyoto_protocol/registry_systems/independent_assessment_reports/items/4061.php [12.11.2012].
- Soliva, C.R. 2006a:** Report to the attention of IPCC about the data set and calculation method used to estimate methane formation from enteric fermentation of agricultural livestock population and manure management in Swiss agriculture. On behalf of the Federal Office for the Environment, Bern. ETH Zurich, Institute of Animal Science.
<http://www.bafu.admin.ch/climatereporting/00545/01913/index.html?lang=en>
[12.12.2012]
- Soliva, C.R. 2006b:** Dokumentation der Berechnungsgrundlage von Methan aus der Verdauung und dem Hofdünger landwirtschaftlicher Nutztiere. Im Auftrag des Bundesamtes für Umwelt, Bern. ETH Zürich, Institut für Nutztierwissenschaften.
<http://www.bafu.admin.ch/climatereporting/00545/01913/index.html?lang=en>
[12.12.2012]
- TA-SWISS 2010:** Future Perspectives of 2nd Generation Biofuels. Rainer Zah, Claudia Binder, Stefan Bringezu, Jürgen Reinhard, Alfons Schmid, Helmut Schütz. vdf Hochschulverlag AG an der ETH Zürich. ISBN 978-3-7281-3334-2. Zentrum für Technologiefolgen-Abschätzung TA-SWISS 55/2010, Zürich.
- Thürig, E., Kaufmann, E., Frisullo, R., Bugmann, H. 2004:** Evaluation of the growth function of an empirical forest scenario model. Forest Ecology and Management 204 (2005), p. 51-66.
- Thürig, E., Palosuo, T., Bucher, J., Kaufmann, E. 2005:** The impact of windthrow on carbon sequestration in Switzerland: a model-based assessment. Forest Ecology and Management 210: 337-350.
http://www.sciencedirect.com/science?_ob=ArticleURL&_udi=B6T6X-4FR8PMC-

[3& user=10& rdoc=1& fmt=& orig=search& sort=d&view=c& acct=C000050221& version=1& urlVersion=0& userid=10&md5=92483bf9c1a1285d05e684f0267a7698](http://www.bafu.admin.ch/climatereporting/00545/01913/index.html?lang=en&lang=en)

[20.12.2012]

Thürig, E., Schmid, S. 2007: Jährliche CO₂ Flüsse im Wald. Berechnungsmethode für das Kyoto Protokoll. [Annual CO₂ fluxes in forests: Calculation method for the Kyoto Protocol]. Schweizerische Zeitschrift für Forstwesen. Submitted.

<http://www.bafu.admin.ch/climatereporting/00545/01913/index.html?lang=en&lang=en>

[20.12.2012]

UBA 2004: Nationales System Emissionsinventare. Zentrales System Emissionen (ZSE). Auszug aus der Datenbank ZSE (Inventar) für verschiedene Quellgruppen nach IPCC. Datenausspielung; U. Döring vom 20.04.2004. Umweltbundesamt, Berlin.

UBA 2005: Emissionen, Aktivitätsraten und Emissionsfaktoren von fluorierten Treibhausgasen (F-Gasen) in Deutschland für die Jahre 1995 – 2002. Texte: 14 / 05. Umwelt Bundes Amt. Berlin.

<http://www.umweltdaten.de/publikationen/fpdf-l/2902.pdf> [German] [03.12.2012]

Vorreiter, L. 1949: Holztechnisches Handbuch. Band I: Allgemeines, Holzkunde, Holzschutz und Holzverwertung. Verlag Georg Fromme & Co., Wien.

VTI 2010: Review of the LULUCF Sector of Switzerland's Greenhouse Gas Inventory 1990–2008. Johann Heinrich von Thünen-Institut Bundesinstitut für Ländliche Räume, Wald und Fischerei. Institut für Agrarrelevante Klimaforschung. Braunschweig/Germany.

Walther U., Menzi, H., Ryser, J.-P., Flisch, R., Jeangros, B., Maillard, A., Siegenthaler, A., Vuilloud, P.A. 1994: Grundlagen für die Düngung im Acker- und Futterbau (GRUDAF). Agrarforschung 1(7): 1-40.

http://www.agrarforschung.ch/de/inh_det.php?id=724 [20.12.2012]

Xinmin, J. 2004: Die Methanemissionen der Schweizer Gasindustrie. Abschätzung der Gasemissionen [Methane emissions from Swiss gas industry. Estimation of methane emissions]. Gas, Wasser, Abwasser 5/2004: 337-345.

<http://www.environment-switzerland.ch/climatereporting/00545/01913/index.html?lang=en>

[12.12.2011]

Annexes

Annex 1: Key Category Analysis

A1.1 Complete KCA 2011 without LULUCF categories

Table A - 1 Complete Key Category Analysis for 2011 without LULUCF categories (Level and Trend Assessment).

Level Assessment

IPCC Source Categories (and fuels if applicable)					Base Year	Current	Level	Cumulative	
Level Assessment					1990	Year			
					Direct Estimate	Estimate			
					GHG (Mt Carbon Equivalent) [Gg CO ₂ eq]	(Mt Carbon Equivalent) [Gg CO ₂ eq]	Assessment	Total Column E-L	
1A3b	1. Energy	A. Fuel Combustion	3. Transport; Road Transportation	Gasoline	CO ₂	60.53	44.33	0.20	0.200
1A3b	1. Energy	A. Fuel Combustion	3. Transport; Road Transportation	Diesel	CO ₂	14.77	31.17	0.14	0.340
1A4a	1. Energy	A. Fuel Combustion	4. Other Sectors; Commercial/Institution	Liquid Fuels	CO ₂	57.10	27.15	0.12	0.462
1A4b	1. Energy	A. Fuel Combustion	4. Other Sectors; Residential	Gaseous Fuels	CO ₂	2.51	22.78	0.10	0.565
1A4a	1. Energy	A. Fuel Combustion	4. Other Sectors; Commercial/Institution	Gaseous Fuels	CO ₂	8.70	19.17	0.09	0.651
4A	4. Agriculture	A. Enteric Fermentation			CH ₄	10.42	10.72	0.05	0.700
1A2	1. Energy	A. Fuel Combustion	2. Manufacturing Industries and Constru	Gaseous Fuels	CO ₂	16.48	10.35	0.05	0.746
1A4b	1. Energy	A. Fuel Combustion	4. Other Sectors; Residential	Liquid Fuels	CO ₂	18.74	8.97	0.04	0.787
1A2	1. Energy	A. Fuel Combustion	2. Manufacturing Industries and Constru	Liquid Fuels	CO ₂	18.74	8.96	0.04	0.827
2F	2. Industrial Proc.	F. Consumption of Halocarbons and SF ₆			HFC	0.00	8.73	0.04	0.866
4D1	4. Agriculture	D. Agricultural Soils; Direct Soil Emissions			N ₂ O	5.45	5.56	0.03	0.891
1A5	1. Energy	A. Fuel Combustion	5. Other	Liquid Fuels	CO ₂	2.36	3.92	0.02	0.909
1A3b	1. Energy	A. Fuel Combustion	3. Transport; Road Transportation	Gaseous Fuels	CO ₂	0.00	3.11	0.01	0.923
1A1	1. Energy	A. Fuel Combustion	1. Energy Industries	Gaseous Fuels	CO ₂	0.12	2.89	0.01	0.936
4D3	4. Agriculture	D. Agricultural Soils; Indirect Emissions			N ₂ O	2.72	2.59	0.01	0.948
4B	4. Agriculture	B. Manure Management			CH ₄	2.16	2.02	0.01	0.957
4B	4. Agriculture	B. Manure Management			N ₂ O	1.21	1.38	0.01	0.963
4D_o	4. Agriculture	D. Agricultural Soils without 4D1-N ₂ O & 4D3-N ₂ O			N ₂ O	0.99	1.10	0.00	0.968
1A4c	1. Energy	A. Fuel Combustion	4. Other Sectors; Agriculture/Forestry	Liquid Fuels	CO ₂	1.30	1.07	0.00	0.973
1B2	1. Energy	B. Fugitive Emissions from 2. Oil and Natural Gas			CH ₄	0.32	1.03	0.00	0.977
6B	6. Waste	B. Wastewater Handling			N ₂ O	0.79	0.97	0.00	0.982
3	3. Solvent and Other Product Use				CO ₂	1.55	0.73	0.00	0.985
1A4b	1. Energy	A. Fuel Combustion	4. Other Sectors; Residential	Biomass	CH ₄	0.13	0.61	0.00	0.988
6D	6. Waste	D. Other			CH ₄	0.40	0.58	0.00	0.990
1A3b	1. Energy	A. Fuel Combustion	3. Transport; Road Transportation	Gasoline	N ₂ O	0.73	0.51	0.00	0.993
3	3. Solvent and Other Product Use				N ₂ O	0.47	0.27	0.00	0.994
1A3a	1. Energy	A. Fuel Combustion	3. Transport; Civil Aviation		CO ₂	0.08	0.15	0.00	0.995
6D	6. Waste	D. Other			N ₂ O	0.08	0.12	0.00	0.995
1A3b	1. Energy	A. Fuel Combustion	3. Transport; Road Transportation	Gasoline	CH ₄	0.54	0.10	0.00	0.996
1A3b	1. Energy	A. Fuel Combustion	3. Transport; Road Transportation	Diesel	N ₂ O	0.03	0.09	0.00	0.996
1A4b	1. Energy	A. Fuel Combustion	4. Other Sectors; Residential	Gaseous Fuels	N ₂ O	0.01	0.08	0.00	0.996
1A1	1. Energy	A. Fuel Combustion	1. Energy Industries	Biomass	N ₂ O	0.05	0.08	0.00	0.997
2F	2. Industrial Proc.	F. Consumption of Halocarbons and SF ₆			PFC	NO	0.07	0.00	0.997
1A4a	1. Energy	A. Fuel Combustion	4. Other Sectors; Commercial/Institution	Liquid Fuels	N ₂ O	0.14	0.07	0.00	0.997
6B	6. Waste	B. Wastewater Handling			CH ₄	0.05	0.07	0.00	0.998
1A4a	1. Energy	A. Fuel Combustion	4. Other Sectors; Commercial/Institution	Biomass	N ₂ O	0.01	0.06	0.00	0.998
1A3b	1. Energy	A. Fuel Combustion	3. Transport; Road Transportation	Gaseous Fuels	CH ₄	0.00	0.06	0.00	0.998
1A4b	1. Energy	A. Fuel Combustion	4. Other Sectors; Residential	Gaseous Fuels	CH ₄	0.01	0.05	0.00	0.998
1A5	1. Energy	A. Fuel Combustion	5. Other	Liquid Fuels	N ₂ O	0.03	0.05	0.00	0.999
1A4a	1. Energy	A. Fuel Combustion	4. Other Sectors; Commercial/Institution	Gaseous Fuels	CH ₄	0.02	0.04	0.00	0.999
1A4b	1. Energy	A. Fuel Combustion	4. Other Sectors; Residential	Biomass	N ₂ O	0.01	0.04	0.00	0.999
6C	6. Waste	C. Waste Incineration			CO ₂	0.03	0.03	0.00	0.999
1A1	1. Energy	A. Fuel Combustion	1. Energy Industries	Gaseous Fuels	CH ₄	0.00	0.03	0.00	0.999
1A2	1. Energy	A. Fuel Combustion	2. Manufacturing Industries and Constru	Gaseous Fuels	CH ₄	0.04	0.02	0.00	0.999
1A4b	1. Energy	A. Fuel Combustion	4. Other Sectors; Residential	Liquid Fuels	N ₂ O	0.05	0.02	0.00	0.999
1A2	1. Energy	A. Fuel Combustion	2. Manufacturing Industries and Constru	Liquid Fuels	N ₂ O	0.05	0.02	0.00	0.999
1A4a	1. Energy	A. Fuel Combustion	4. Other Sectors; Commercial/Institution	Biomass	CH ₄	0.00	0.02	0.00	1.000
2F	2. Industrial Proc.	F. Consumption of Halocarbons and SF ₆			SF ₆	NO	0.01	0.00	1.000
6A	6. Waste	A. Solid Waste Disposal on Land			CH ₄	0.22	0.01	0.00	1.000
1A4c	1. Energy	A. Fuel Combustion	4. Other Sectors; Agriculture/Forestry	Liquid Fuels	N ₂ O	0.01	0.01	0.00	1.000
1A4a	1. Energy	A. Fuel Combustion	4. Other Sectors; Commercial/Institution	Gaseous Fuels	N ₂ O	0.00	0.01	0.00	1.000
1A4a	1. Energy	A. Fuel Combustion	4. Other Sectors; Commercial/Institution	Liquid Fuels	CH ₄	0.02	0.01	0.00	1.000
1A2	1. Energy	A. Fuel Combustion	2. Manufacturing Industries and Constru	Gaseous Fuels	N ₂ O	0.01	0.01	0.00	1.000
6C	6. Waste	C. Waste Incineration			CH ₄	0.01	0.01	0.00	1.000
1A4b	1. Energy	A. Fuel Combustion	4. Other Sectors; Residential	Solid Fuels	CO ₂	0.09	0.00	0.00	1.000
1A3b	1. Energy	A. Fuel Combustion	3. Transport; Road Transportation	Diesel	CH ₄	0.01	0.00	0.00	1.000
1A1	1. Energy	A. Fuel Combustion	1. Energy Industries	Biomass	CH ₄	0.00	0.00	0.00	1.000
1A4b	1. Energy	A. Fuel Combustion	4. Other Sectors; Residential	Liquid Fuels	CH ₄	0.01	0.00	0.00	1.000
1A2	1. Energy	A. Fuel Combustion	2. Manufacturing Industries and Constru	Liquid Fuels	CH ₄	0.01	0.00	0.00	1.000
1A3b	1. Energy	A. Fuel Combustion	3. Transport; Road Transportation	Biomass	N ₂ O	0.00	0.00	0.00	1.000
1A1	1. Energy	A. Fuel Combustion	1. Energy Industries	Gaseous Fuels	N ₂ O	0.00	0.00	0.00	1.000
1A3a	1. Energy	A. Fuel Combustion	3. Transport; Civil Aviation		N ₂ O	0.00	0.00	0.00	1.000
1A5	1. Energy	A. Fuel Combustion	5. Other	Liquid Fuels	CH ₄	0.00	0.00	0.00	1.000
1A4b	1. Energy	A. Fuel Combustion	4. Other Sectors; Residential	Solid Fuels	CH ₄	0.01	0.00	0.00	1.000
1A4c	1. Energy	A. Fuel Combustion	4. Other Sectors; Agriculture/Forestry	Liquid Fuels	CH ₄	0.00	0.00	0.00	1.000
6C	6. Waste	C. Waste Incineration			N ₂ O	0.00	0.00	0.00	1.000
1A4b	1. Energy	A. Fuel Combustion	4. Other Sectors; Residential	Solid Fuels	N ₂ O	0.00	0.00	0.00	1.000
1A3a	1. Energy	A. Fuel Combustion	3. Transport; Civil Aviation		CH ₄	0.00	0.00	0.00	1.000
1A1	1. Energy	A. Fuel Combustion	1. Energy Industries	Liquid Fuels	CO ₂	NO	NO	0.00	1.000
1A1	1. Energy	A. Fuel Combustion	1. Energy Industries	Solid Fuels	CO ₂	NO	NO	0.00	1.000
1A1	1. Energy	A. Fuel Combustion	1. Energy Industries	Other Fuels	CO ₂	NO	NO	0.00	1.000
1A1	1. Energy	A. Fuel Combustion	1. Energy Industries	Liquid Fuels	CH ₄	0.00	0.00	0.00	1.000
1A1	1. Energy	A. Fuel Combustion	1. Energy Industries	Solid Fuels	CH ₄	0.00	0.00	0.00	1.000
1A1	1. Energy	A. Fuel Combustion	1. Energy Industries	Other Fuels	CH ₄	0.00	0.00	0.00	1.000
1A1	1. Energy	A. Fuel Combustion	1. Energy Industries	Liquid Fuels	N ₂ O	0.00	0.00	0.00	1.000
1A1	1. Energy	A. Fuel Combustion	1. Energy Industries	Solid Fuels	N ₂ O	0.00	0.00	0.00	1.000
1A1	1. Energy	A. Fuel Combustion	1. Energy Industries	Other Fuels	N ₂ O	0.00	0.00	0.00	1.000
1A2	1. Energy	A. Fuel Combustion	2. Manufacturing Industries and Constru	Solid Fuels	CO ₂	NO	NO	0.00	1.000
1A2	1. Energy	A. Fuel Combustion	2. Manufacturing Industries and Constru	Other Fuels	CO ₂	NO	NO	0.00	1.000
1A2	1. Energy	A. Fuel Combustion	2. Manufacturing Industries and Constru	Solid Fuels	CH ₄	0.00	0.00	0.00	1.000
1A2	1. Energy	A. Fuel Combustion	2. Manufacturing Industries and Constru	Biomass	CH ₄	0.00	0.00	0.00	1.000

(Cont'd next page)

IPCC Source Categories (and fuels if applicable) Level Assessment				Base Year 1990 Estimate Direct GHG Equivalent [Gg CO2eq]	Current Year Estimate (Mt Carbon Equivalent) [Gg CO2eq]	Level Assessment	Cumulative Total Column E-L		
1A2	1. Energy	A. Fuel Combustion	2. Manufacturing Industries and Constru	Other Fuels	CH4	0.00	0.00	0.00	1.000
1A2	1. Energy	A. Fuel Combustion	2. Manufacturing Industries and Constru	Solid Fuels	N2O	0.00	0.00	0.00	1.000
1A2	1. Energy	A. Fuel Combustion	2. Manufacturing Industries and Constru	Biomass	N2O	0.00	0.00	0.00	1.000
1A2	1. Energy	A. Fuel Combustion	2. Manufacturing Industries and Constru	Other Fuels	N2O	0.00	0.00	0.00	1.000
1A3b	1. Energy	A. Fuel Combustion	3. Transport; Road Transportation	Biomass	CH4	0.00	0.00	0.00	1.000
1A3b	1. Energy	A. Fuel Combustion	3. Transport; Road Transportation	Gaseous Fuels	N2O	0.00	0.00	0.00	1.000
1A3e	1. Energy	A. Fuel Combustion	3. Transport; Other Transportation (milit;		0 CO2	NO	NO	0.00	1.000
1A3e	1. Energy	A. Fuel Combustion	3. Transport; Other Transportation (milit;		0 CH4	0.00	0.00	0.00	1.000
1A3e	1. Energy	A. Fuel Combustion	3. Transport; Other Transportation (milit;		0 N2O	0.00	0.00	0.00	1.000
1A4a	1. Energy	A. Fuel Combustion	4. Other Sectors; Commercial/Institution	Solid Fuels	CO2	NO	NO	0.00	1.000
1A4a	1. Energy	A. Fuel Combustion	4. Other Sectors; Commercial/Institution	Solid Fuels	CH4	0.00	0.00	0.00	1.000
1A4a	1. Energy	A. Fuel Combustion	4. Other Sectors; Commercial/Institution	Solid Fuels	N2O	0.00	0.00	0.00	1.000
1A4c	1. Energy	A. Fuel Combustion	4. Other Sectors; Agriculture/Forestry	Gaseous Fuels	CO2	NO	NO	0.00	1.000
1A4c	1. Energy	A. Fuel Combustion	4. Other Sectors; Agriculture/Forestry	Gaseous Fuels	CH4	0.00	0.00	0.00	1.000
1A4c	1. Energy	A. Fuel Combustion	4. Other Sectors; Agriculture/Forestry	Gaseous Fuels	N2O	0.00	0.00	0.00	1.000
1B2	1. Energy	B. Fugitive Emissions from 2. Oil and Natural Gas			CO2	NA,NO	NA,NO	0.00	1.000
1B2	1. Energy	B. Fugitive Emissions from 2. Oil and Natural Gas			N2O	NA,NO	NA,NO	0.00	1.000
2A	2. Industrial Proc.	A. Mineral Products			CO2	NO	NO	0.00	1.000
2A	2. Industrial Proc.	A. Mineral Products			CH4	NO	NO	0.00	1.000
2A	2. Industrial Proc.	A. Mineral Products			N2O	NO	NO	0.00	1.000
2B	2. Industrial Proc.	B. Chemical Industry			CO2	NO	NO	0.00	1.000
2B	2. Industrial Proc.	B. Chemical Industry			CH4	NO	NO	0.00	1.000
2B	2. Industrial Proc.	B. Chemical Industry			N2O	NO	NO	0.00	1.000
2C	2. Industrial Proc.	C. Metal Production			CO2	NO	NO	0.00	1.000
2C	2. Industrial Proc.	C. Metal Production			CH4	NO	NO	0.00	1.000
2C	2. Industrial Proc.	C. Metal Production			N2O	NO	NO	0.00	1.000
2D	2. Industrial Proc.	D. Other Production			CO2	NO	NO	0.00	1.000
2E	2. Industrial Proc.	E. Production of Halocarbons and SF6			CO2	0.00	0.00	0.00	1.000
2F	2. Industrial Proc.	F. Consumption of Halocarbons and SF6			CO2	0.00	0.00	0.00	1.000
2G	2. Industrial Proc.	G. Other			CO2	NO	NO	0.00	1.000
2G	2. Industrial Proc.	G. Other			CH4	NO	NO	0.00	1.000
2G	2. Industrial Proc.	G. Other			N2O	NO	NO	0.00	1.000
4C	4. Agriculture	C. Rice Cultivation			CH4	NA,NO	NA,NO	0.00	1.000
4D	4. Agriculture	D. Agricultural Soils			CH4	NA,NO	NA,NO	0.00	1.000
4E	4. Agriculture	E. Prescribed Burning of Savannas			CH4	NA	NA	0.00	1.000
4E	4. Agriculture	E. Prescribed Burning of Savannas			N2O	NA	NA	0.00	1.000
4F	4. Agriculture	F. Field Burning of Agricultural Residues			CH4	NA,NO	NA,NO	0.00	1.000
4F	4. Agriculture	F. Field Burning of Agricultural Residues			N2O	NA,NO	NA,NO	0.00	1.000
4G	4. Agriculture	G. Other			CH4	NA	NA	0.00	1.000
4G	4. Agriculture	G. Other			N2O	NA	NA	0.00	1.000
6A	6. Waste	A. Solid Waste Disposal on Land			CO2	NO	NO	0.00	1.000
6D	6. Waste	D. Other			CO2	NO	NO	0.00	1.000
TOTAL					<i>All</i>	230.33	222.04	1.00	1.000

Trend Assessment

IPCC Source Categories (and fuels if applicable) Trend Assessment					Base Year			Trend Assessment	Cumulative Total Col. F-T
					Direct GHG	1990 Estimate [Gg CO2eq]	Current Year Estimate [Gg CO2eq]		
1A4a	1. Energy	A. Fuel Combustion	4. Other Sectors; Commercial/Institutional	Liquid Fuels	CO2	57.10	27.15	0.130291	0.205
1A4b	1. Energy	A. Fuel Combustion	4. Other Sectors; Residential	Gaseous Fuels	CO2	2.51	22.78	0.095145	0.355
1A3b	1. Energy	A. Fuel Combustion	3. Transport; Road Transportation	Diesel	CO2	14.77	31.17	0.079126	0.480
1A3b	1. Energy	A. Fuel Combustion	3. Transport; Road Transportation	Gasoline	CO2	60.53	44.33	0.065496	0.583
1A4a	1. Energy	A. Fuel Combustion	4. Other Sectors; Commercial/Institutional	Gaseous Fuels	CO2	8.70	19.17	0.050382	0.663
1A2	1. Energy	A. Fuel Combustion	2. Manufacturing Industries and Construction	Liquid Fuels	CO2	18.74	8.96	0.042555	0.730
1A4b	1. Energy	A. Fuel Combustion	4. Other Sectors; Residential	Liquid Fuels	CO2	18.74	8.97	0.042497	0.797
2F	2. Industrial Proc.	F. Consumption of Halocarbons and SF6		HFC		0.00	8.73	0.040781	0.861
1A2	1. Energy	A. Fuel Combustion	2. Manufacturing Industries and Construction	Gaseous Fuels	CO2	16.48	10.35	0.025886	0.902
1A3b	1. Energy	A. Fuel Combustion	3. Transport; Road Transportation	Gaseous Fuels	CO2	0.00	3.11	0.014523	0.925
1A1	1. Energy	A. Fuel Combustion	1. Energy Industries	Gaseous Fuels	CO2	0.12	2.89	0.012970	0.945
1A5	1. Energy	A. Fuel Combustion	5. Other	Liquid Fuels	CO2	2.36	3.92	0.007663	0.958
3	3. Solvent and Other Product Use								
1B2	1. Energy	B. Fugitive Emissions from F2, Oil and Natural Gas			CO2	1.55	0.73	0.003559	0.963
					CH4	0.32	1.03	0.003390	0.969
4A	4. Agriculture	A. Enteric Fermentation			CH4	10.42	10.72	0.003171	0.974
1A4b	1. Energy	A. Fuel Combustion	4. Other Sectors; Residential	Biomass	CH4	0.13	0.61	0.002239	0.977
1A3b	1. Energy	A. Fuel Combustion	3. Transport; Road Transportation	Gasoline	CH4	0.54	0.10	0.001958	0.980
4D1	4. Agriculture	D. Agricultural Soils; Direct Soil Emissions			N2O	5.45	5.56	0.001405	0.982
4B	4. Agriculture	B. Manure Management			N2O	1.21	1.38	0.000994	0.984
6B	6. Waste	B. Wastewater Handling			N2O	0.79	0.97	0.000969	0.985
1A3b	1. Energy	A. Fuel Combustion	3. Transport; Road Transportation	Gasoline	N2O	0.73	0.51	0.000938	0.987
6A	6. Waste	A. Solid Waste Disposal on Land			CH4	0.22	0.01	0.000929	0.988
6D	6. Waste	D. Other			CH4	0.40	0.58	0.000888	0.990
3	3. Solvent and Other Product Use				N2O	0.47	0.27	0.000878	0.991
1A4c	1. Energy	A. Fuel Combustion	4. Other Sectors; Agriculture/Forestry	Liquid Fuels	CO2	1.30	1.07	0.000857	0.993
4D_o	4. Agriculture	D. Agricultural Soils without 4D1-N2O & 4D3-N2O			N2O	0.99	1.10	0.000660	0.994
1A4b	1. Energy	A. Fuel Combustion	4. Other Sectors; Residential	Solid Fuels	CO2	0.09	0.00	0.000389	0.994
1A3a	1. Energy	A. Fuel Combustion	3. Transport; Civil Aviation		CO2	0.08	0.15	0.000345	0.995
1A4a	1. Energy	A. Fuel Combustion	4. Other Sectors; Commercial/Institutional	Liquid Fuels	N2O	0.14	0.07	0.000323	0.995
1A4b	1. Energy	A. Fuel Combustion	4. Other Sectors; Residential	Gaseous Fuels	N2O	0.01	0.08	0.000322	0.996
4B	4. Agriculture	B. Manure Management			CH4	2.16	2.02	0.000293	0.996
1A3b	1. Energy	A. Fuel Combustion	3. Transport; Road Transportation	Diesel	N2O	0.03	0.09	0.000279	0.997
1A3b	1. Energy	A. Fuel Combustion	3. Transport; Road Transportation	Gaseous Fuels	CH4	0.00	0.06	0.000277	0.997
1A4a	1. Energy	A. Fuel Combustion	4. Other Sectors; Commercial/Institutional	Biomass	N2O	0.01	0.06	0.000227	0.997
1A4b	1. Energy	A. Fuel Combustion	4. Other Sectors; Residential	Gaseous Fuels	CH4	0.01	0.05	0.000218	0.998
6D	6. Waste	D. Other			N2O	0.08	0.12	0.000183	0.998
4D3	4. Agriculture	D. Agricultural Soils; Indirect Emissions			N2O	2.72	2.59	0.000161	0.998
1A4b	1. Energy	A. Fuel Combustion	4. Other Sectors; Residential	Biomass	N2O	0.01	0.04	0.000151	0.999
1A1	1. Energy	A. Fuel Combustion	1. Energy Industries	Gaseous Fuels	CH4	0.00	0.03	0.000124	0.999
1A1	1. Energy	A. Fuel Combustion	1. Energy Industries	Biomass	N2O	0.05	0.08	0.000119	0.999
1A4a	1. Energy	A. Fuel Combustion	4. Other Sectors; Commercial/Institutional	Gaseous Fuels	CH4	0.02	0.04	0.000115	0.999
1A4b	1. Energy	A. Fuel Combustion	4. Other Sectors; Residential	Liquid Fuels	N2O	0.05	0.02	0.000107	0.999
1A5	1. Energy	A. Fuel Combustion	5. Other	Liquid Fuels	N2O	0.03	0.05	0.000094	0.999
1A4a	1. Energy	A. Fuel Combustion	4. Other Sectors; Commercial/Institutional	Biomass	CH4	0.00	0.02	0.000077	1.000
1A2	1. Energy	A. Fuel Combustion	2. Manufacturing Industries and Construction	Gaseous Fuels	CH4	0.04	0.02	0.000059	1.000
1A4a	1. Energy	A. Fuel Combustion	4. Other Sectors; Commercial/Institutional	Liquid Fuels	CH4	0.02	0.01	0.000038	1.000
1A4a	1. Energy	A. Fuel Combustion	4. Other Sectors; Commercial/Institutional	Gaseous Fuels	N2O	0.00	0.01	0.000028	1.000
1A4b	1. Energy	A. Fuel Combustion	4. Other Sectors; Residential	Solid Fuels	CH4	0.01	0.00	0.000026	1.000
1A3b	1. Energy	A. Fuel Combustion	3. Transport; Road Transportation	Diesel	CH4	0.01	0.00	0.000020	1.000
6C	6. Waste	C. Waste Incineration			CO2	0.03	0.03	0.000018	1.000
1A2	1. Energy	A. Fuel Combustion	2. Manufacturing Industries and Construction	Gaseous Fuels	N2O	0.01	0.01	0.000015	1.000
1A2	1. Energy	A. Fuel Combustion	2. Manufacturing Industries and Construction	Liquid Fuels	CH4	0.01	0.00	0.000012	1.000
1A4b	1. Energy	A. Fuel Combustion	4. Other Sectors; Residential	Liquid Fuels	CH4	0.01	0.00	0.000012	1.000
1A3b	1. Energy	A. Fuel Combustion	3. Transport; Road Transportation	Biomass	N2O	0.00	0.00	0.000008	1.000
1A4c	1. Energy	A. Fuel Combustion	4. Other Sectors; Agriculture/Forestry	Liquid Fuels	N2O	0.01	0.01	0.000008	1.000
1A1	1. Energy	A. Fuel Combustion	1. Energy Industries	Gaseous Fuels	N2O	0.00	0.00	0.000007	1.000
1A1	1. Energy	A. Fuel Combustion	1. Energy Industries	Biomass	CH4	0.00	0.00	0.000004	1.000
1A3a	1. Energy	A. Fuel Combustion	3. Transport; Civil Aviation		N2O	0.00	0.00	0.000003	1.000
6C	6. Waste	C. Waste Incineration			CH4	0.01	0.01	0.000003	1.000
1A4b	1. Energy	A. Fuel Combustion	4. Other Sectors; Residential	Solid Fuels	N2O	0.00	0.00	0.000002	1.000
1A5	1. Energy	A. Fuel Combustion	5. Other	Liquid Fuels	CH4	0.00	0.00	0.000002	1.000
1A4c	1. Energy	A. Fuel Combustion	4. Other Sectors; Agriculture/Forestry	Liquid Fuels	CH4	0.00	0.00	0.000000	1.000
6C	6. Waste	C. Waste Incineration			N2O	0.00	0.00	0.000000	1.000
1A3a	1. Energy	A. Fuel Combustion	3. Transport; Civil Aviation		CH4	0.00	0.00	0.000000	1.000
1A1	1. Energy	A. Fuel Combustion	1. Energy Industries	Liquid Fuels	CO2	NO	NO	0.000000	1.000
1A1	1. Energy	A. Fuel Combustion	1. Energy Industries	Solid Fuels	CO2	NO	NO	0.000000	1.000
1A1	1. Energy	A. Fuel Combustion	1. Energy Industries	Other Fuels	CO2	NO	NO	0.000000	1.000
1A1	1. Energy	A. Fuel Combustion	1. Energy Industries	Liquid Fuels	CH4	0.00	0.00	0.000000	1.000
1A1	1. Energy	A. Fuel Combustion	1. Energy Industries	Solid Fuels	CH4	0.00	0.00	0.000000	1.000
1A1	1. Energy	A. Fuel Combustion	1. Energy Industries	Other Fuels	CH4	0.00	0.00	0.000000	1.000
1A1	1. Energy	A. Fuel Combustion	1. Energy Industries	Liquid Fuels	N2O	0.00	0.00	0.000000	1.000
1A1	1. Energy	A. Fuel Combustion	1. Energy Industries	Solid Fuels	N2O	0.00	0.00	0.000000	1.000
1A1	1. Energy	A. Fuel Combustion	1. Energy Industries	Other Fuels	N2O	0.00	0.00	0.000000	1.000
1A2	1. Energy	A. Fuel Combustion	2. Manufacturing Industries and Construction	Liquid Fuels	N2O	0.05	0.02	0.000000	1.000
1A2	1. Energy	A. Fuel Combustion	2. Manufacturing Industries and Construction	Solid Fuels	CO2	NO	NO	0.000000	1.000
1A2	1. Energy	A. Fuel Combustion	2. Manufacturing Industries and Construction	Other Fuels	CO2	NO	NO	0.000000	1.000
1A2	1. Energy	A. Fuel Combustion	2. Manufacturing Industries and Construction	Solid Fuels	CH4	0.00	0.00	0.000000	1.000
1A2	1. Energy	A. Fuel Combustion	2. Manufacturing Industries and Construction	Biomass	CH4	0.00	0.00	0.000000	1.000
1A2	1. Energy	A. Fuel Combustion	2. Manufacturing Industries and Construction	Other Fuels	CH4	0.00	0.00	0.000000	1.000
1A2	1. Energy	A. Fuel Combustion	2. Manufacturing Industries and Construction	Solid Fuels	N2O	0.00	0.00	0.000000	1.000
1A2	1. Energy	A. Fuel Combustion	2. Manufacturing Industries and Construction	Biomass	N2O	0.00	0.00	0.000000	1.000

(Cont'd next page)

IPCC Source Categories (and fuels if applicable)					Direct GHG	Base Year		Trend Assessment	Cumulative Total Col. F-T
Trend Assessment						1990 Estimate	Current Year Estimate		
					[Gg CO ₂ eq]	[Gg CO ₂ eq]			
1A2	1. Energy	A. Fuel Combustion	2. Manufacturing Industries and Construction	Other Fuels	N2O	0.00	0.00	0.000000	1.000
1A3b	1. Energy	A. Fuel Combustion	3. Transport; Road Transportation	Biomass	CH4	0.00	0.00	0.000000	1.000
1A3b	1. Energy	A. Fuel Combustion	3. Transport; Road Transportation	Gaseous Fuels	N2O	0.00	0.00	0.000000	1.000
1A3e	1. Energy	A. Fuel Combustion	3. Transport; Other Transportation (military aviation)		CO2	NO	NO	0.000000	1.000
1A3e	1. Energy	A. Fuel Combustion	3. Transport; Other Transportation (military aviation)		CH4	0.00	0.00	0.000000	1.000
1A3e	1. Energy	A. Fuel Combustion	3. Transport; Other Transportation (military aviation)		N2O	0.00	0.00	0.000000	1.000
1A4a	1. Energy	A. Fuel Combustion	4. Other Sectors; Commercial/Institutional	Solid Fuels	CO2	NO	NO	0.000000	1.000
1A4a	1. Energy	A. Fuel Combustion	4. Other Sectors; Commercial/Institutional	Solid Fuels	CH4	0.00	0.00	0.000000	1.000
1A4a	1. Energy	A. Fuel Combustion	4. Other Sectors; Commercial/Institutional	Solid Fuels	N2O	0.00	0.00	0.000000	1.000
1A4c	1. Energy	A. Fuel Combustion	4. Other Sectors; Agriculture/Forestry	Gaseous Fuels	CO2	NO	NO	0.000000	1.000
1A4c	1. Energy	A. Fuel Combustion	4. Other Sectors; Agriculture/Forestry	Gaseous Fuels	CH4	0.00	0.00	0.000000	1.000
1A4c	1. Energy	A. Fuel Combustion	4. Other Sectors; Agriculture/Forestry	Gaseous Fuels	N2O	0.00	0.00	0.000000	1.000
1B2	1. Energy	B. Fugitive Emissions from F2. Oil and Natural Gas			CO2	NA,NO	NA,NO	0.000000	1.000
1B2	1. Energy	B. Fugitive Emissions from F2. Oil and Natural Gas			N2O	NA,NO	NA,NO	0.000000	1.000
2A	2. Industrial Proc.	A. Mineral Products			CO2	NO	NO	0.000000	1.000
2A	2. Industrial Proc.	A. Mineral Products			CH4	NO	NO	0.000000	1.000
2A	2. Industrial Proc.	A. Mineral Products			N2O	NO	NO	0.000000	1.000
2B	2. Industrial Proc.	B. Chemical Industry			CO2	NO	NO	0.000000	1.000
2B	2. Industrial Proc.	B. Chemical Industry			CH4	NO	NO	0.000000	1.000
2B	2. Industrial Proc.	B. Chemical Industry			N2O	NO	NO	0.000000	1.000
2C	2. Industrial Proc.	C. Metal Production			CO2	NO	NO	0.000000	1.000
2C	2. Industrial Proc.	C. Metal Production			CH4	NO	NO	0.000000	1.000
2C	2. Industrial Proc.	C. Metal Production			N2O	NO	NO	0.000000	1.000
2D	2. Industrial Proc.	D. Other Production			CO2	NO	NO	0.000000	1.000
2E	2. Industrial Proc.	E. Production of Halocarbons and SF6			CO2	0.00	0.00	0.000000	1.000
2F	2. Industrial Proc.	F. Consumption of Halocarbons and SF6			PFC	NO	0.07	0.000000	1.000
2F	2. Industrial Proc.	F. Consumption of Halocarbons and SF6			SF6	NO	0.01	0.000000	1.000
2F	2. Industrial Proc.	F. Consumption of Halocarbons and SF6			CO2	0.00	0.00	0.000000	1.000
2G	2. Industrial Proc.	G. Other			CO2	NO	NO	0.000000	1.000
2G	2. Industrial Proc.	G. Other			CH4	NO	NO	0.000000	1.000
2G	2. Industrial Proc.	G. Other			N2O	NO	NO	0.000000	1.000
4C	4. Agriculture	C. Rice Cultivation			CH4	NA,NO	NA,NO	0.000000	1.000
4D	4. Agriculture	D. Agricultural Soils			CH4	NA,NO	NA,NO	0.000000	1.000
4E	4. Agriculture	E. Prescribed Burning of Savannas			CH4	NA	NA	0.000000	1.000
4E	4. Agriculture	E. Prescribed Burning of Savannas			N2O	NA	NA	0.000000	1.000
4F	4. Agriculture	F. Field Burning of Agricultural Residues			CH4	NA,NO	NA,NO	0.000000	1.000
4F	4. Agriculture	F. Field Burning of Agricultural Residues			N2O	NA,NO	NA,NO	0.000000	1.000
4G	4. Agriculture	G. Other			CH4	NA	NA	0.000000	1.000
4G	4. Agriculture	G. Other			N2O	NA	NA	0.000000	1.000
6A	6. Waste	A. Solid Waste Disposal on Land			CO2	NO	NO	0.000000	1.000
6B	6. Waste	B. Wastewater Handling			CH4	0.05	0.07	0.000000	1.000
6D	6. Waste	D. Other			CO2	NO	NO	0.000000	1.000
TOTAL					<i>All</i>	230.33	222.04		

Table A - 2 Complete Key Category Analysis for 2011 without LULUCF categories (Summary).

IPCC Source Categories (and fuels if applicable) Source Category Analysis Summary					Direct GHG	Key Source Category Flag	If Column C is Yes, Criteria for Identification
1A3b	1. Energy	A. Fuel Combustion	3. Transport; Road Transportation	Gasoline	CO2	yes	Level, Trend
1A3b	1. Energy	A. Fuel Combustion	3. Transport; Road Transportation	Diesel	CO2	yes	Level, Trend
1A4a	1. Energy	A. Fuel Combustion	4. Other Sectors; Commercial/Institutional	Liquid Fuels	CO2	yes	Level, Trend
1A4b	1. Energy	A. Fuel Combustion	4. Other Sectors; Residential	Gaseous Fuels	CO2	yes	Level, Trend
1A4a	1. Energy	A. Fuel Combustion	4. Other Sectors; Commercial/Institutional	Gaseous Fuels	CO2	yes	Level, Trend
4A	4. Agriculture	A. Enteric Fermentation			CH4	yes	Level
1A2	1. Energy	A. Fuel Combustion	2. Manufacturing Industries and Construction	Gaseous Fuels	CO2	yes	Level, Trend
1A4b	1. Energy	A. Fuel Combustion	4. Other Sectors; Residential	Liquid Fuels	CO2	yes	Level, Trend
1A2	1. Energy	A. Fuel Combustion	2. Manufacturing Industries and Construction	Liquid Fuels	CO2	yes	Level, Trend
2F	2. Industrial Proc.	F. Consumption of Halocarbons:			HFC	yes	Level, Trend
4D1	4. Agriculture	D. Agricultural Soils; Direct Soil			N2O	yes	Level
1A5	1. Energy	A. Fuel Combustion	5. Other	Liquid Fuels	CO2	yes	Level, Trend
1A3b	1. Energy	A. Fuel Combustion	3. Transport; Road Transportation	Gaseous Fuels	CO2	yes	Level, Trend
1A1	1. Energy	A. Fuel Combustion	1. Energy Industries	Gaseous Fuels	CO2	yes	Level, Trend
4D3	4. Agriculture	D. Agricultural Soils; Indirect Er			N2O	yes	Level
4B	4. Agriculture	B. Manure Management			CH4	yes	Level
4B	4. Agriculture	B. Manure Management			N2O	no	
4D_o	4. Agriculture	D. Agricultural Soils without 4D			N2O	no	
1A4c	1. Energy	A. Fuel Combustion	4. Other Sectors; Agriculture/Forestry	Liquid Fuels	CO2	no	
1B2	1. Energy	B. Fugitive Emissions from Fue	2. Oil and Natural Gas		CH4	no	
6B	6. Waste	B. Wastewater Handling			N2O	no	
3	3. Solvent and Ot				CO2	no	
1A4b	1. Energy	A. Fuel Combustion	4. Other Sectors; Residential	Biomass	CH4	no	
6D	6. Waste	D. Other			CH4	no	
1A3b	1. Energy	A. Fuel Combustion	3. Transport; Road Transportation	Gasoline	N2O	no	
3	3. Solvent and Ot				N2O	no	
1A3a	1. Energy	A. Fuel Combustion	3. Transport; Civil Aviation		CO2	no	
6D	6. Waste	D. Other			N2O	no	
1A3b	1. Energy	A. Fuel Combustion	3. Transport; Road Transportation	Gasoline	CH4	no	
1A3b	1. Energy	A. Fuel Combustion	3. Transport; Road Transportation	Diesel	N2O	no	
1A4b	1. Energy	A. Fuel Combustion	4. Other Sectors; Residential	Gaseous Fuels	N2O	no	
1A1	1. Energy	A. Fuel Combustion	1. Energy Industries	Biomass	N2O	no	
2F	2. Industrial Proc.	F. Consumption of Halocarbons:			PFC	no	
1A4a	1. Energy	A. Fuel Combustion	4. Other Sectors; Commercial/Institutional	Liquid Fuels	N2O	no	
6B	6. Waste	B. Wastewater Handling			CH4	no	
1A4a	1. Energy	A. Fuel Combustion	4. Other Sectors; Commercial/Institutional	Biomass	N2O	no	
1A3b	1. Energy	A. Fuel Combustion	3. Transport; Road Transportation	Gaseous Fuels	CH4	no	
1A4b	1. Energy	A. Fuel Combustion	4. Other Sectors; Residential	Gaseous Fuels	CH4	no	
1A5	1. Energy	A. Fuel Combustion	5. Other	Liquid Fuels	N2O	no	
1A4a	1. Energy	A. Fuel Combustion	4. Other Sectors; Commercial/Institutional	Gaseous Fuels	CH4	no	
1A4b	1. Energy	A. Fuel Combustion	4. Other Sectors; Residential	Biomass	N2O	no	
6C	6. Waste	C. Waste Incineration			CO2	no	
1A1	1. Energy	A. Fuel Combustion	1. Energy Industries	Gaseous Fuels	CH4	no	
1A2	1. Energy	A. Fuel Combustion	2. Manufacturing Industries and Construction	Gaseous Fuels	CH4	no	
1A4b	1. Energy	A. Fuel Combustion	4. Other Sectors; Residential	Liquid Fuels	N2O	no	
1A2	1. Energy	A. Fuel Combustion	2. Manufacturing Industries and Construction	Liquid Fuels	N2O	no	
1A4a	1. Energy	A. Fuel Combustion	4. Other Sectors; Commercial/Institutional	Biomass	CH4	no	
2F	2. Industrial Proc.	F. Consumption of Halocarbons:			SF6	no	
6A	6. Waste	A. Solid Waste Disposal on Lar			CH4	no	
1A4c	1. Energy	A. Fuel Combustion	4. Other Sectors; Agriculture/Forestry	Liquid Fuels	N2O	no	
1A4a	1. Energy	A. Fuel Combustion	4. Other Sectors; Commercial/Institutional	Gaseous Fuels	N2O	no	
1A4a	1. Energy	A. Fuel Combustion	4. Other Sectors; Commercial/Institutional	Liquid Fuels	CH4	no	
1A2	1. Energy	A. Fuel Combustion	2. Manufacturing Industries and Construction	Gaseous Fuels	N2O	no	
6C	6. Waste	C. Waste Incineration			CH4	no	
1A4b	1. Energy	A. Fuel Combustion	4. Other Sectors; Residential	Solid Fuels	CO2	no	
1A3b	1. Energy	A. Fuel Combustion	3. Transport; Road Transportation	Diesel	CH4	no	
1A1	1. Energy	A. Fuel Combustion	1. Energy Industries	Biomass	CH4	no	
1A4b	1. Energy	A. Fuel Combustion	4. Other Sectors; Residential	Liquid Fuels	CH4	no	
1A2	1. Energy	A. Fuel Combustion	2. Manufacturing Industries and Construction	Liquid Fuels	CH4	no	
1A3b	1. Energy	A. Fuel Combustion	3. Transport; Road Transportation	Biomass	N2O	no	
1A1	1. Energy	A. Fuel Combustion	1. Energy Industries	Gaseous Fuels	N2O	no	
1A3a	1. Energy	A. Fuel Combustion	3. Transport; Civil Aviation		N2O	no	
1A5	1. Energy	A. Fuel Combustion	5. Other	Liquid Fuels	CH4	no	
1A4b	1. Energy	A. Fuel Combustion	4. Other Sectors; Residential	Solid Fuels	CH4	no	
1A4c	1. Energy	A. Fuel Combustion	4. Other Sectors; Agriculture/Forestry	Liquid Fuels	CH4	no	
6C	6. Waste	C. Waste Incineration			N2O	no	
1A4b	1. Energy	A. Fuel Combustion	4. Other Sectors; Residential	Solid Fuels	N2O	no	
1A3a	1. Energy	A. Fuel Combustion	3. Transport; Civil Aviation		CH4	no	
1A1	1. Energy	A. Fuel Combustion	1. Energy Industries	Liquid Fuels	CO2	no	
1A1	1. Energy	A. Fuel Combustion	1. Energy Industries	Solid Fuels	CO2	no	
1A1	1. Energy	A. Fuel Combustion	1. Energy Industries	Other Fuels	CO2	no	
1A1	1. Energy	A. Fuel Combustion	1. Energy Industries	Liquid Fuels	CH4	no	
1A1	1. Energy	A. Fuel Combustion	1. Energy Industries	Solid Fuels	CH4	no	
1A1	1. Energy	A. Fuel Combustion	1. Energy Industries	Other Fuels	CH4	no	
1A1	1. Energy	A. Fuel Combustion	1. Energy Industries	Liquid Fuels	N2O	no	
1A1	1. Energy	A. Fuel Combustion	1. Energy Industries	Solid Fuels	N2O	no	
1A1	1. Energy	A. Fuel Combustion	1. Energy Industries	Other Fuels	N2O	no	
1A2	1. Energy	A. Fuel Combustion	2. Manufacturing Industries and Construction	Solid Fuels	CO2	no	
1A2	1. Energy	A. Fuel Combustion	2. Manufacturing Industries and Construction	Other Fuels	CO2	no	
1A2	1. Energy	A. Fuel Combustion	2. Manufacturing Industries and Construction	Solid Fuels	CH4	no	
1A2	1. Energy	A. Fuel Combustion	2. Manufacturing Industries and Construction	Biomass	CH4	no	

(Cont'd next page)

IPCC Source Categories (and fuels if applicable)					Key	If Column C
Source Category Analysis Summary					Source	is Yes,
					Category	Criteria for
					GHG	Identification
					Flag	
1A2	1. Energy	A. Fuel Combustion	2. Manufacturing Industries and Construction	Solid Fuels	N2O	no
1A2	1. Energy	A. Fuel Combustion	2. Manufacturing Industries and Construction	Biomass	N2O	no
1A2	1. Energy	A. Fuel Combustion	2. Manufacturing Industries and Construction	Other Fuels	N2O	no
1A3b	1. Energy	A. Fuel Combustion	3. Transport; Road Transportation	Biomass	CH4	no
1A3b	1. Energy	A. Fuel Combustion	3. Transport; Road Transportation	Gaseous Fuels	N2O	no
1A3e	1. Energy	A. Fuel Combustion	3. Transport; Other Transportation (military aviati		CO2	no
1A3e	1. Energy	A. Fuel Combustion	3. Transport; Other Transportation (military aviati		CH4	no
1A3e	1. Energy	A. Fuel Combustion	3. Transport; Other Transportation (military aviati		N2O	no
1A4a	1. Energy	A. Fuel Combustion	4. Other Sectors; Commercial/Institutional	Solid Fuels	CO2	no
1A4a	1. Energy	A. Fuel Combustion	4. Other Sectors; Commercial/Institutional	Solid Fuels	CH4	no
1A4a	1. Energy	A. Fuel Combustion	4. Other Sectors; Commercial/Institutional	Solid Fuels	N2O	no
1A4c	1. Energy	A. Fuel Combustion	4. Other Sectors; Agriculture/Forestry	Gaseous Fuels	CO2	no
1A4c	1. Energy	A. Fuel Combustion	4. Other Sectors; Agriculture/Forestry	Gaseous Fuels	CH4	no
1A4c	1. Energy	A. Fuel Combustion	4. Other Sectors; Agriculture/Forestry	Gaseous Fuels	N2O	no
1B2	1. Energy	B. Fugitive Emissions from Fue 2. Oil and Natural Gas			CO2	no
1B2	1. Energy	B. Fugitive Emissions from Fue 2. Oil and Natural Gas			N2O	no
2A	2. Industrial Proc. A. Mineral Products				CO2	no
2A	2. Industrial Proc. A. Mineral Products				CH4	no
2A	2. Industrial Proc. A. Mineral Products				N2O	no
2B	2. Industrial Proc. B. Chemical Industry				CO2	no
2B	2. Industrial Proc. B. Chemical Industry				CH4	no
2B	2. Industrial Proc. B. Chemical Industry				N2O	no
2C	2. Industrial Proc. C. Metal Production				CO2	no
2C	2. Industrial Proc. C. Metal Production				CH4	no
2C	2. Industrial Proc. C. Metal Production				N2O	no
2D	2. Industrial Proc. D. Other Production				CO2	no
2E	2. Industrial Proc. E. Production of Halocarbons and SF6				CO2	no
2F	2. Industrial Proc. F. Consumption of Halocarbons and SF6				CO2	no
2G	2. Industrial Proc. G. Other				CO2	no
2G	2. Industrial Proc. G. Other				CH4	no
2G	2. Industrial Proc. G. Other				N2O	no
4C	4. Agriculture	C. Rice Cultivation			CH4	no
4D	4. Agriculture	D. Agricultural Soils			CH4	no
4E	4. Agriculture	E. Prescribed Burning of Savannas			CH4	no
4E	4. Agriculture	E. Prescribed Burning of Savannas			N2O	no
4F	4. Agriculture	F. Field Burning of Agricultural Residues			CH4	no
4F	4. Agriculture	F. Field Burning of Agricultural Residues			N2O	no
4G	4. Agriculture	G. Other			CH4	no
4G	4. Agriculture	G. Other			N2O	no
6A	6. Waste	A. Solid Waste Disposal on Land			CO2	no
6D	6. Waste	D. Other			CO2	no

A1.2 Complete KCA 2011 including LULUCF categories

Table A - 3 Liechtenstein's key categories in 2011 including LULUCF categories (Level and Trend Assessment).
In accordance with GPG (IPCC 2000) estimates for removals are accounted with a positive sign.

Level Assessment

IPCC Source Categories (and fuels if applicable)						Base Year	Current	Level	Cumulative
Level Assessment						Direct	Year	Assessment	Total
						GHG	Estimate	Estimate	Column E-L
							[Gg CO ₂ eq]	[Gg CO ₂ eq]	
1A3b	1. Energy	A. Fuel Combustion	3. Transport; Road Transportation	Gasoline	CO ₂	60.53	44.33	0.17	0.174
1A3b	1. Energy	A. Fuel Combustion	3. Transport; Road Transportation	Diesel	CO ₂	14.77	31.17	0.12	0.296
1A4a	1. Energy	A. Fuel Combustion	4. Other Sectors; Commercial/Institutional	Liquid Fuels	CO ₂	57.10	27.15	0.11	0.403
1A4b	1. Energy	A. Fuel Combustion	4. Other Sectors; Residential	Gaseous Fuels	CO ₂	2.51	22.78	0.09	0.492
1A4a	1. Energy	A. Fuel Combustion	4. Other Sectors; Commercial/Institutional	Gaseous Fuels	CO ₂	8.70	19.17	0.08	0.567
5A1	5. LULUCF	A. Forest Land	1. Forest Land remaining Forest Land		CO ₂	17.89	18.34	0.07	0.639
4A	4. Agriculture	A. Enteric Fermentation			CH ₄	10.42	10.72	0.04	0.681
1A2	1. Energy	A. Fuel Combustion	2. Manufacturing Industries and Constructi	Gaseous Fuels	CO ₂	16.48	10.35	0.04	0.722
1A4b	1. Energy	A. Fuel Combustion	4. Other Sectors; Residential	Liquid Fuels	CO ₂	18.74	8.97	0.04	0.757
1A2	1. Energy	A. Fuel Combustion	2. Manufacturing Industries and Constructi	Liquid Fuels	CO ₂	18.74	8.96	0.04	0.792
2F	2. Industrial Proc	F. Consumption of Halocarbons and SF ₆			HFC	0.00	8.73	0.03	0.826
4D1	4. Agriculture	D. Agricultural Soils; Direct Soil Emissions			N ₂ O	5.45	5.56	0.02	0.848
5B1	5. LULUCF	B. Cropland	1. Cropland remaining Cropland		CO ₂	4.10	4.37	0.02	0.865
1A5	1. Energy	A. Fuel Combustion	5. Other	Liquid Fuels	CO ₂	2.36	3.92	0.02	0.881
5E2	5. LULUCF	E. Settlements	2. Land converted to Settlements		CO ₂	3.30	3.48	0.01	0.894
1A3b	1. Energy	A. Fuel Combustion	3. Transport; Road Transportation	Gaseous Fuels	CO ₂	0.00	3.11	0.01	0.907
1A1	1. Energy	A. Fuel Combustion	1. Energy Industries	Gaseous Fuels	CO ₂	0.12	2.89	0.01	0.918
4D3	4. Agriculture	D. Agricultural Soils; Indirect Emissions			N ₂ O	2.72	2.59	0.01	0.928
5C2	5. LULUCF	C. Grassland	2. Land converted to Grassland		CO ₂	0.30	2.05	0.01	0.936
4B	4. Agriculture	B. Manure Management			CH ₄	2.16	2.02	0.01	0.944
5A2	5. LULUCF	A. Forest Land	2. Land converted to Forest Land		CO ₂	2.10	1.62	0.01	0.950
4B	4. Agriculture	B. Manure Management			N ₂ O	1.21	1.38	0.01	0.956
5F2	5. LULUCF	F. Other Land	2. Land converted to Other Land		CO ₂	0.44	1.15	0.00	0.960
5C1	5. LULUCF	C. Grassland	1. Grassland remaining Grassland		CO ₂	1.60	1.13	0.00	0.965
4D_o	4. Agriculture	D. Agricultural Soils without 4D1-N ₂ O & 4D3-N ₂ O			N ₂ O	0.99	1.10	0.00	0.969
1A4c	1. Energy	A. Fuel Combustion	4. Other Sectors; Agriculture/Forestry	Liquid Fuels	CO ₂	1.30	1.07	0.00	0.973
1B2	1. Energy	B. Fugitive Emissions 12. Oil and Natural Gas			CH ₄	0.32	1.03	0.00	0.977
6B	6. Waste	B. Wastewater Handling			N ₂ O	0.79	0.97	0.00	0.981
3	3. Solvent and Other Product Use				CO ₂	1.55	0.73	0.00	0.984
1A4b	1. Energy	A. Fuel Combustion	4. Other Sectors; Residential	Biomass	CH ₄	0.13	0.61	0.00	0.986
6D	6. Waste	D. Other			CH ₄	0.40	0.58	0.00	0.989
1A3b	1. Energy	A. Fuel Combustion	3. Transport; Road Transportation	Gasoline	N ₂ O	0.73	0.51	0.00	0.991
5E1	5. LULUCF	E. Settlements	1. Settlements remaining Settlements		CO ₂	0.28	0.29	0.00	0.992
3	3. Solvent and Other Product Use				N ₂ O	0.47	0.27	0.00	0.993
5B2	5. LULUCF	B. Cropland	2. Land converted to Cropland		CO ₂	0.34	0.22	0.00	0.994
5D2	5. LULUCF	D. Wetlands	2. Land converted to Wetlands		CO ₂	0.16	0.22	0.00	0.995
1A3a	1. Energy	A. Fuel Combustion	3. Transport; Civil Aviation		CO ₂	0.08	0.15	0.00	0.995
6D	6. Waste	D. Other			N ₂ O	0.08	0.12	0.00	0.996
1A3b	1. Energy	A. Fuel Combustion	3. Transport; Road Transportation	Gasoline	CH ₄	0.54	0.10	0.00	0.996
1A3b	1. Energy	A. Fuel Combustion	3. Transport; Road Transportation	Diesel	N ₂ O	0.03	0.09	0.00	0.996
1A4b	1. Energy	A. Fuel Combustion	4. Other Sectors; Residential	Gaseous Fuels	N ₂ O	0.01	0.08	0.00	0.997
1A1	1. Energy	A. Fuel Combustion	1. Energy Industries	Biomass	N ₂ O	0.05	0.08	0.00	0.997
2F	2. Industrial Proc	F. Consumption of Halocarbons and SF ₆			PFC	NO	0.07	0.00	0.997
1A4a	1. Energy	A. Fuel Combustion	4. Other Sectors; Commercial/Institutional	Liquid Fuels	N ₂ O	0.14	0.07	0.00	0.998
6B	6. Waste	B. Wastewater Handling			CH ₄	0.05	0.07	0.00	0.998
1A4a	1. Energy	A. Fuel Combustion	4. Other Sectors; Commercial/Institutional	Biomass	N ₂ O	0.01	0.06	0.00	0.998
1A3b	1. Energy	A. Fuel Combustion	3. Transport; Road Transportation	Biomass	CH ₄	0.00	0.06	0.00	0.998
1A4b	1. Energy	A. Fuel Combustion	4. Other Sectors; Residential	Gaseous Fuels	CH ₄	0.01	0.05	0.00	0.998
1A5	1. Energy	A. Fuel Combustion	5. Other	Liquid Fuels	N ₂ O	0.03	0.05	0.00	0.999
1A4a	1. Energy	A. Fuel Combustion	4. Other Sectors; Commercial/Institutional	Gaseous Fuels	CH ₄	0.02	0.04	0.00	0.999
1A4b	1. Energy	A. Fuel Combustion	4. Other Sectors; Residential	Biomass	N ₂ O	0.01	0.04	0.00	0.999
6C	6. Waste	C. Waste Incineration			CO ₂	0.03	0.03	0.00	0.999
1A1	1. Energy	A. Fuel Combustion	1. Energy Industries	Gaseous Fuels	CH ₄	0.00	0.03	0.00	0.999
1A2	1. Energy	A. Fuel Combustion	2. Manufacturing Industries and Constructi	Gaseous Fuels	CH ₄	0.04	0.02	0.00	0.999
1A4b	1. Energy	A. Fuel Combustion	4. Other Sectors; Residential	Liquid Fuels	N ₂ O	0.05	0.02	0.00	0.999
1A2	1. Energy	A. Fuel Combustion	2. Manufacturing Industries and Constructi	Liquid Fuels	N ₂ O	0.05	0.02	0.00	1.000
1A4a	1. Energy	A. Fuel Combustion	4. Other Sectors; Commercial/Institutional	Biomass	CH ₄	0.00	0.02	0.00	1.000
5B2	5. LULUCF	B. Cropland	2. Land converted to Cropland		N ₂ O	0.01	0.01	0.00	1.000
2F	2. Industrial Proc	F. Consumption of Halocarbons and SF ₆			SF ₆	NO	0.01	0.00	1.000
6A	6. Waste	A. Solid Waste Disposal on Land			CH ₄	0.22	0.01	0.00	1.000
1A4c	1. Energy	A. Fuel Combustion	4. Other Sectors; Agriculture/Forestry	Liquid Fuels	N ₂ O	0.01	0.01	0.00	1.000
1A4a	1. Energy	A. Fuel Combustion	4. Other Sectors; Commercial/Institutional	Gaseous Fuels	N ₂ O	0.00	0.01	0.00	1.000
1A4a	1. Energy	A. Fuel Combustion	4. Other Sectors; Commercial/Institutional	Liquid Fuels	CH ₄	0.02	0.01	0.00	1.000
1A2	1. Energy	A. Fuel Combustion	2. Manufacturing Industries and Constructi	Gaseous Fuels	N ₂ O	0.01	0.01	0.00	1.000
6C	6. Waste	C. Waste Incineration			CH ₄	0.01	0.01	0.00	1.000
1A4b	1. Energy	A. Fuel Combustion	4. Other Sectors; Residential	Solid Fuels	CO ₂	0.09	0.00	0.00	1.000
1A3b	1. Energy	A. Fuel Combustion	3. Transport; Road Transportation	Diesel	CH ₄	0.01	0.00	0.00	1.000
1A1	1. Energy	A. Fuel Combustion	1. Energy Industries	Biomass	CH ₄	0.00	0.00	0.00	1.000
1A4b	1. Energy	A. Fuel Combustion	4. Other Sectors; Residential	Liquid Fuels	CH ₄	0.01	0.00	0.00	1.000
1A2	1. Energy	A. Fuel Combustion	2. Manufacturing Industries and Constructi	Liquid Fuels	CH ₄	0.01	0.00	0.00	1.000
1A3b	1. Energy	A. Fuel Combustion	3. Transport; Road Transportation	Biomass	N ₂ O	0.00	0.00	0.00	1.000
1A1	1. Energy	A. Fuel Combustion	1. Energy Industries	Gaseous Fuels	N ₂ O	0.00	0.00	0.00	1.000
1A3a	1. Energy	A. Fuel Combustion	3. Transport; Civil Aviation		N ₂ O	0.00	0.00	0.00	1.000
1A5	1. Energy	A. Fuel Combustion	5. Other	Liquid Fuels	CH ₄	0.00	0.00	0.00	1.000
1A4b	1. Energy	A. Fuel Combustion	4. Other Sectors; Residential	Solid Fuels	CH ₄	0.01	0.00	0.00	1.000
1A4c	1. Energy	A. Fuel Combustion	4. Other Sectors; Agriculture/Forestry	Liquid Fuels	CH ₄	0.00	0.00	0.00	1.000
6C	6. Waste	C. Waste Incineration			N ₂ O	0.00	0.00	0.00	1.000
1A4b	1. Energy	A. Fuel Combustion	4. Other Sectors; Residential	Solid Fuels	N ₂ O	0.00	0.00	0.00	1.000
1A3a	1. Energy	A. Fuel Combustion	3. Transport; Civil Aviation		CH ₄	0.00	0.00	0.00	1.000
1A1	1. Energy	A. Fuel Combustion	1. Energy Industries	Liquid Fuels	CO ₂	NO	NO	0.00	1.000
1A1	1. Energy	A. Fuel Combustion	1. Energy Industries	Solid Fuels	CO ₂	NO	NO	0.00	1.000

(Cont'd next page)

IPCC Source Categories (and fuels if applicable)					Direct GHG	Base Year 1990 Estimate [Gg CO ₂ eq]	Current Year Estimate [Gg CO ₂ eq]	Level Assessment	Cumulative Total Column E- L
Level	Assessment	Category	Fuel	GHG					
1A1	1. Energy	A. Fuel Combustion	1. Energy Industries	Other Fuels	CO2	NO	NO	0.00	1.000
1A1	1. Energy	A. Fuel Combustion	1. Energy Industries	Liquid Fuels	CH4	0.00	0.00	0.00	1.000
1A1	1. Energy	A. Fuel Combustion	1. Energy Industries	Solid Fuels	CH4	0.00	0.00	0.00	1.000
1A1	1. Energy	A. Fuel Combustion	1. Energy Industries	Other Fuels	CH4	0.00	0.00	0.00	1.000
1A1	1. Energy	A. Fuel Combustion	1. Energy Industries	Liquid Fuels	N2O	0.00	0.00	0.00	1.000
1A1	1. Energy	A. Fuel Combustion	1. Energy Industries	Solid Fuels	N2O	0.00	0.00	0.00	1.000
1A1	1. Energy	A. Fuel Combustion	1. Energy Industries	Other Fuels	N2O	0.00	0.00	0.00	1.000
1A2	1. Energy	A. Fuel Combustion	2. Manufacturing Industries and Construct	Solid Fuels	CO2	NO	NO	0.00	1.000
1A2	1. Energy	A. Fuel Combustion	2. Manufacturing Industries and Construct	Other Fuels	CO2	NO	NO	0.00	1.000
1A2	1. Energy	A. Fuel Combustion	2. Manufacturing Industries and Construct	Solid Fuels	CH4	0.00	0.00	0.00	1.000
1A2	1. Energy	A. Fuel Combustion	2. Manufacturing Industries and Construct	Biomass	CH4	0.00	0.00	0.00	1.000
1A2	1. Energy	A. Fuel Combustion	2. Manufacturing Industries and Construct	Other Fuels	CH4	0.00	0.00	0.00	1.000
1A2	1. Energy	A. Fuel Combustion	2. Manufacturing Industries and Construct	Solid Fuels	N2O	0.00	0.00	0.00	1.000
1A2	1. Energy	A. Fuel Combustion	2. Manufacturing Industries and Construct	Biomass	N2O	0.00	0.00	0.00	1.000
1A2	1. Energy	A. Fuel Combustion	2. Manufacturing Industries and Construct	Other Fuels	N2O	0.00	0.00	0.00	1.000
1A3b	1. Energy	A. Fuel Combustion	3. Transport; Road Transportation	Gaseous Fuels	CH4	0.00	0.00	0.00	1.000
1A3b	1. Energy	A. Fuel Combustion	3. Transport; Road Transportation	Gaseous Fuels	N2O	0.00	0.00	0.00	1.000
1A3e	1. Energy	A. Fuel Combustion	3. Transport; Other Transportation (militar		0 CO2	NO	NO	0.00	1.000
1A3e	1. Energy	A. Fuel Combustion	3. Transport; Other Transportation (militar		0 CH4	0.00	0.00	0.00	1.000
1A3e	1. Energy	A. Fuel Combustion	3. Transport; Other Transportation (militar		0 N2O	0.00	0.00	0.00	1.000
1A4a	1. Energy	A. Fuel Combustion	4. Other Sectors; Commercial/Institutional	Solid Fuels	CO2	NO	NO	0.00	1.000
1A4a	1. Energy	A. Fuel Combustion	4. Other Sectors; Commercial/Institutional	Solid Fuels	CH4	0.00	0.00	0.00	1.000
1A4a	1. Energy	A. Fuel Combustion	4. Other Sectors; Commercial/Institutional	Solid Fuels	N2O	0.00	0.00	0.00	1.000
1A4c	1. Energy	A. Fuel Combustion	4. Other Sectors; Agriculture/Forestry	Gaseous Fuels	CO2	NO	NO	0.00	1.000
1A4c	1. Energy	A. Fuel Combustion	4. Other Sectors; Agriculture/Forestry	Gaseous Fuels	CH4	0.00	0.00	0.00	1.000
1A4c	1. Energy	A. Fuel Combustion	4. Other Sectors; Agriculture/Forestry	Gaseous Fuels	N2O	0.00	0.00	0.00	1.000
1B2	1. Energy	B. Fugitive Emissions	12. Oil and Natural Gas		0 CO2	NA,NO	NA,NO	0.00	1.000
1B2	1. Energy	B. Fugitive Emissions	12. Oil and Natural Gas		0 N2O	NA,NO	NA,NO	0.00	1.000
2A	2. Industrial Proc	A. Mineral Products		0	0 CO2	NO	NO	0.00	1.000
2A	2. Industrial Proc	A. Mineral Products		0	0 CH4	NO	NO	0.00	1.000
2A	2. Industrial Proc	A. Mineral Products		0	0 N2O	NO	NO	0.00	1.000
2B	2. Industrial Proc	B. Chemical Industry		0	0 CO2	NO	NO	0.00	1.000
2B	2. Industrial Proc	B. Chemical Industry		0	0 CH4	NO	NO	0.00	1.000
2B	2. Industrial Proc	B. Chemical Industry		0	0 N2O	NO	NO	0.00	1.000
2C	2. Industrial Proc	C. Metal Production		0	0 CO2	NO	NO	0.00	1.000
2C	2. Industrial Proc	C. Metal Production		0	0 CH4	NO	NO	0.00	1.000
2C	2. Industrial Proc	C. Metal Production		0	0 N2O	NO	NO	0.00	1.000
2D	2. Industrial Proc	D. Other Production		0	0 CO2	NO	NO	0.00	1.000
2E	2. Industrial Proc	E. Production of Haloc		0	0 CO2	0.00	0.00	0.00	1.000
2F	2. Industrial Proc	F. Consumption of Hal		0	0 CO2	0.00	0.00	0.00	1.000
2G	2. Industrial Proc	G. Other		0	0 CO2	NO	NO	0.00	1.000
2G	2. Industrial Proc	G. Other		0	0 CH4	NO	NO	0.00	1.000
2G	2. Industrial Proc	G. Other		0	0 N2O	NO	NO	0.00	1.000
4C	4. Agriculture	C. Rice Cultivation		0	0 CH4	NA,NO	NA,NO	0.00	1.000
4D	4. Agriculture	D. Agricultural Soils		0	0 CH4	NA,NO	NA,NO	0.00	1.000
4E	4. Agriculture	E. Prescribed Burning		0	0 CH4	NA	NA	0.00	1.000
4E	4. Agriculture	E. Prescribed Burning		0	0 N2O	NA	NA	0.00	1.000
4F	4. Agriculture	F. Field Burning of Agr		0	0 CH4	NA,NO	NA,NO	0.00	1.000
4F	4. Agriculture	F. Field Burning of Agr		0	0 N2O	NA,NO	NA,NO	0.00	1.000
4G	4. Agriculture	G. Other		0	0 CH4	NA	NA	0.00	1.000
4G	4. Agriculture	G. Other		0	0 N2O	NA	NA	0.00	1.000
5A1	5. LULUCF	A. Forest Land	1. Forest Land remaining Forest Land		0 CH4	0.00	0.00	0.00	1.000
5A1	5. LULUCF	A. Forest Land	1. Forest Land remaining Forest Land		0 N2O	0.00	0.00	0.00	1.000
5D1	5. LULUCF	D. Wetlands	1. Wetlands remaining Wetlands		0 CO2	0.00	0.00	0.00	1.000
6A	6. Waste	A. Solid Waste Dispos.		0	0 CO2	NO	NO	0.00	1.000
6D	6. Waste	D. Other		0	0 CO2	NO	NO	0.00	1.000
TOTAL					All	260.85	254.93	1.00	1.000

Trend Assessment

IPCC Source Categories (and fuels if applicable)					Base Year	Current	Trend	Cumulative	
Trend Assessment					Direct	Year	Assessment	Total Col.	
					GHG	Estimate	Estimate	F-T	
						[Gg CO ₂ eq]	[Gg CO ₂ eq]		
1A4a	1. Energy	A. Fuel Combustion	4. Other Sectors; Commercial/Institutional	Liquid Fuels	CO2	57.10	27.15	0.114984	0.201
1A4b	1. Energy	A. Fuel Combustion	4. Other Sectors; Residential	Gaseous Fuels	CO2	2.51	22.78	0.081610	0.344
1A3b	1. Energy	A. Fuel Combustion	3. Transport; Road Transportation	Diesel	CO2	14.77	31.17	0.067194	0.461
1A3b	1. Energy	A. Fuel Combustion	3. Transport; Road Transportation	Gasoline	CO2	60.53	44.33	0.059498	0.565
1A4a	1. Energy	A. Fuel Combustion	4. Other Sectors; Commercial/Institutional	Gaseous Fuels	CO2	8.70	19.17	0.042822	0.640
1A2	1. Energy	A. Fuel Combustion	2. Manufacturing Industries and Construct	Liquid Fuels	CO2	18.74	8.96	0.037560	0.705
1A4b	1. Energy	A. Fuel Combustion	4. Other Sectors; Residential	Liquid Fuels	CO2	18.74	8.97	0.037510	0.771
2F	2. Industrial Proc	F. Consumption of Halocarbons and SF6			HFC	0.00	8.73	0.035037	0.832
1A2	1. Energy	A. Fuel Combustion	2. Manufacturing Industries and Construct	Gaseous Fuels	CO2	16.48	10.35	0.023119	0.873
1A3b	1. Energy	A. Fuel Combustion	3. Transport; Road Transportation	Gaseous Fuels	CO2	0.00	3.11	0.012477	0.894
1A1	1. Energy	A. Fuel Combustion	1. Energy Industries	Gaseous Fuels	CO2	0.12	2.89	0.011137	0.914
5C2	5. LULUCF	C. Grassland	2. Land converted to Grassland		CO2	0.30	2.05	0.007067	0.926
1A5	1. Energy	A. Fuel Combustion	5. Other	Liquid Fuels	CO2	2.36	3.92	0.006457	0.937
5A1	5. LULUCF	A. Forest Land	1. Forest Land remaining Forest Land		CO2	17.89	18.34	0.003408	0.943
5F2	5. LULUCF	F. Other Land	2. Land converted to Other Land		CO2	0.44	1.15	0.002913	0.954
3	3. Solvent and Other Product Use				CO2	1.55	0.73	0.003140	0.949
1B2	1. Energy	B. Fugitive Emissions	12. Oil and Natural Gas		CH4	0.32	1.03	0.002896	0.959
4A	4. Agriculture	A. Enteric Fermentation			CH4	10.42	10.72	0.002169	0.963
1A4b	1. Energy	A. Fuel Combustion	4. Other Sectors; Residential	Biomass	CH4	0.13	0.61	0.001916	0.966
5C1	5. LULUCF	C. Grassland	1. Grassland remaining Grassland		CO2	1.60	1.13	0.001780	0.969
5A2	5. LULUCF	A. Forest Land	2. Land converted to Forest Land		CO2	2.10	1.62	0.001723	0.972
1A3b	1. Energy	A. Fuel Combustion	3. Transport; Road Transportation	Gasoline	CH4	0.54	0.10	0.001711	0.975
5B1	5. LULUCF	B. Cropland	1. Cropland remaining Cropland		CO2	4.10	4.37	0.001492	0.978
5E2	5. LULUCF	E. Settlements	2. Land converted to Settlements		CO2	3.30	3.48	0.001020	0.980
4D1	4. Agriculture	D. Agricultural Soils; Direct Soil Emissions			N2O	5.45	5.56	0.000916	0.981
1A3b	1. Energy	A. Fuel Combustion	3. Transport; Road Transportation	Gasoline	N2O	0.73	0.51	0.000845	0.983
6A	6. Waste	A. Solid Waste Disposal on Land			CH4	0.22	0.01	0.000810	0.984
1A4c	1. Energy	A. Fuel Combustion	4. Other Sectors; Agriculture/Forestry	Liquid Fuels	CO2	1.30	1.07	0.000806	0.986
6B	6. Waste	B. Wastewater Handling			N2O	0.79	0.97	0.000790	0.987
4B	4. Agriculture	B. Manure Management			N2O	1.21	1.38	0.000789	0.988
3	3. Solvent and Other Product Use				N2O	0.47	0.27	0.000779	0.990
6D	6. Waste	D. Other			CH4	0.40	0.58	0.000741	0.991
4D_o	4. Agriculture	D. Agricultural Soils without 4D1-N2O & 4D3-N2O			N2O	0.99	1.10	0.000514	0.992
5B2	5. LULUCF	B. Cropland	2. Land converted to Cropland		CO2	0.34	0.22	0.000472	0.993
4B	4. Agriculture	B. Manure Management			CH4	2.16	2.02	0.000367	0.993
1A4b	1. Energy	A. Fuel Combustion	4. Other Sectors; Residential	Solid Fuels	CO2	0.09	0.00	0.000339	0.994
1A3a	1. Energy	A. Fuel Combustion	3. Transport; Civil Aviation		CO2	0.08	0.15	0.000292	0.994
1A4a	1. Energy	A. Fuel Combustion	4. Other Sectors; Commercial/Institutional	Liquid Fuels	N2O	0.14	0.07	0.000285	0.995
4D3	4. Agriculture	D. Agricultural Soils; Indirect Emissions			N2O	2.72	2.59	0.000283	0.995
1A4b	1. Energy	A. Fuel Combustion	4. Other Sectors; Residential	Gaseous Fuels	N2O	0.01	0.08	0.000276	0.996
5D2	5. LULUCF	D. Wetlands	2. Land converted to Wetlands		CO2	0.16	0.22	0.000260	0.996
1A3b	1. Energy	A. Fuel Combustion	3. Transport; Road Transportation	Diesel	N2O	0.03	0.09	0.000238	0.997
1A3b	1. Energy	A. Fuel Combustion	3. Transport; Road Transportation	Biomass	CH4	0.00	0.06	0.000238	0.997
1A4a	1. Energy	A. Fuel Combustion	4. Other Sectors; Commercial/Institutional	Biomass	N2O	0.01	0.06	0.000194	0.998
1A4b	1. Energy	A. Fuel Combustion	4. Other Sectors; Residential	Gaseous Fuels	CH4	0.01	0.05	0.000187	0.998
6D	6. Waste	D. Other			N2O	0.08	0.12	0.000153	0.998
1A4b	1. Energy	A. Fuel Combustion	4. Other Sectors; Residential	Biomass	N2O	0.01	0.04	0.000129	0.998
1A1	1. Energy	A. Fuel Combustion	1. Energy Industries	Gaseous Fuels	CH4	0.00	0.03	0.000106	0.999
1A1	1. Energy	A. Fuel Combustion	1. Energy Industries	Biomass	N2O	0.05	0.08	0.000100	0.999
1A4a	1. Energy	A. Fuel Combustion	4. Other Sectors; Commercial/Institutional	Gaseous Fuels	CH4	0.02	0.04	0.000098	0.999
1A4b	1. Energy	A. Fuel Combustion	4. Other Sectors; Residential	Liquid Fuels	N2O	0.05	0.02	0.000094	0.999
6B	6. Waste	B. Wastewater Handling			CH4	0.05	0.07	0.000086	0.999
1A5	1. Energy	A. Fuel Combustion	5. Other	Liquid Fuels	N2O	0.03	0.05	0.000079	0.999
5E1	5. LULUCF	E. Settlements	1. Settlements remaining Settlements		CO2	0.28	0.29	0.000075	0.999
1A4a	1. Energy	A. Fuel Combustion	4. Other Sectors; Commercial/Institutional	Biomass	CH4	0.00	0.02	0.000066	1.000
1A2	1. Energy	A. Fuel Combustion	2. Manufacturing Industries and Construct	Gaseous Fuels	CH4	0.04	0.02	0.000053	1.000
1A4a	1. Energy	A. Fuel Combustion	4. Other Sectors; Commercial/Institutional	Liquid Fuels	CH4	0.02	0.01	0.000034	1.000
1A4a	1. Energy	A. Fuel Combustion	4. Other Sectors; Commercial/Institutional	Gaseous Fuels	N2O	0.00	0.01	0.000024	1.000
1A4b	1. Energy	A. Fuel Combustion	4. Other Sectors; Residential	Solid Fuels	CH4	0.01	0.00	0.000023	1.000
5B2	5. LULUCF	B. Cropland	2. Land converted to Cropland		N2O	0.01	0.01	0.000020	1.000
1A3b	1. Energy	A. Fuel Combustion	3. Transport; Road Transportation	Diesel	CH4	0.01	0.00	0.000017	1.000
6C	6. Waste	C. Waste Incineration			CO2	0.03	0.03	0.000014	1.000
1A2	1. Energy	A. Fuel Combustion	2. Manufacturing Industries and Construct	Gaseous Fuels	N2O	0.01	0.01	0.000013	1.000
1A2	1. Energy	A. Fuel Combustion	2. Manufacturing Industries and Construct	Liquid Fuels	CH4	0.01	0.00	0.000011	1.000
1A4b	1. Energy	A. Fuel Combustion	4. Other Sectors; Residential	Liquid Fuels	CH4	0.01	0.00	0.000011	1.000
1A4c	1. Energy	A. Fuel Combustion	4. Other Sectors; Agriculture/Forestry	Liquid Fuels	N2O	0.01	0.01	0.000007	1.000
1A3b	1. Energy	A. Fuel Combustion	3. Transport; Road Transportation	Biomass	N2O	0.00	0.00	0.000007	1.000
1A1	1. Energy	A. Fuel Combustion	1. Energy Industries	Gaseous Fuels	N2O	0.00	0.00	0.000006	1.000
1A1	1. Energy	A. Fuel Combustion	1. Energy Industries	Biomass	CH4	0.00	0.00	0.000004	1.000
1A3a	1. Energy	A. Fuel Combustion	3. Transport; Civil Aviation		N2O	0.00	0.00	0.000003	1.000
6C	6. Waste	C. Waste Incineration			CH4	0.01	0.01	0.000002	1.000
1A4b	1. Energy	A. Fuel Combustion	4. Other Sectors; Residential	Solid Fuels	N2O	0.00	0.00	0.000002	1.000
1A5	1. Energy	A. Fuel Combustion	5. Other	Liquid Fuels	CH4	0.00	0.00	0.000001	1.000
1A4c	1. Energy	A. Fuel Combustion	4. Other Sectors; Agriculture/Forestry	Liquid Fuels	CH4	0.00	0.00	0.000000	1.000
6C	6. Waste	C. Waste Incineration			N2O	0.00	0.00	0.000000	1.000
1A3a	1. Energy	A. Fuel Combustion	3. Transport; Civil Aviation		CH4	0.00	0.00	0.000000	1.000
1A1	1. Energy	A. Fuel Combustion	1. Energy Industries	Liquid Fuels	CO2	NO	NO	0.000000	1.000
1A1	1. Energy	A. Fuel Combustion	1. Energy Industries	Solid Fuels	CO2	NO	NO	0.000000	1.000
1A1	1. Energy	A. Fuel Combustion	1. Energy Industries	Other Fuels	CO2	NO	NO	0.000000	1.000
1A1	1. Energy	A. Fuel Combustion	1. Energy Industries	Liquid Fuels	CH4	0.00	0.00	0.000000	1.000
1A1	1. Energy	A. Fuel Combustion	1. Energy Industries	Solid Fuels	CH4	0.00	0.00	0.000000	1.000

(Cont'd next page)

IPCC Source Categories (and fuels if applicable)					Direct	Base Year	Current	Trend	Cumulative
Trend Assessment					GHG	1990	Year	Assessment	Total Col.
						Estimate	Estimate		F-T
						[Gg CO2eq]	[Gg CO2eq]		
1A1	1. Energy	A. Fuel Combustion	1. Energy Industries	Solid Fuels	CH4	0.00	0.00	0.000000	1.000
1A1	1. Energy	A. Fuel Combustion	1. Energy Industries	Other Fuels	CH4	0.00	0.00	0.000000	1.000
1A1	1. Energy	A. Fuel Combustion	1. Energy Industries	Liquid Fuels	N2O	0.00	0.00	0.000000	1.000
1A1	1. Energy	A. Fuel Combustion	1. Energy Industries	Solid Fuels	N2O	0.00	0.00	0.000000	1.000
1A1	1. Energy	A. Fuel Combustion	1. Energy Industries	Other Fuels	N2O	0.00	0.00	0.000000	1.000
1A2	1. Energy	A. Fuel Combustion	2. Manufacturing Industries and Construct	Liquid Fuels	N2O	0.05	0.02	0.000000	1.000
1A2	1. Energy	A. Fuel Combustion	2. Manufacturing Industries and Construct	Solid Fuels	CO2	NO	NO	0.000000	1.000
1A2	1. Energy	A. Fuel Combustion	2. Manufacturing Industries and Construct	Other Fuels	CO2	NO	NO	0.000000	1.000
1A2	1. Energy	A. Fuel Combustion	2. Manufacturing Industries and Construct	Solid Fuels	CH4	0.00	0.00	0.000000	1.000
1A2	1. Energy	A. Fuel Combustion	2. Manufacturing Industries and Construct	Biomass	CH4	0.00	0.00	0.000000	1.000
1A2	1. Energy	A. Fuel Combustion	2. Manufacturing Industries and Construct	Other Fuels	CH4	0.00	0.00	0.000000	1.000
1A2	1. Energy	A. Fuel Combustion	2. Manufacturing Industries and Construct	Solid Fuels	N2O	0.00	0.00	0.000000	1.000
1A2	1. Energy	A. Fuel Combustion	2. Manufacturing Industries and Construct	Biomass	N2O	0.00	0.00	0.000000	1.000
1A2	1. Energy	A. Fuel Combustion	2. Manufacturing Industries and Construct	Other Fuels	N2O	0.00	0.00	0.000000	1.000
1A3b	1. Energy	A. Fuel Combustion	3. Transport; Road Transportation	Gaseous Fuels	CH4	0.00	0.00	0.000000	1.000
1A3b	1. Energy	A. Fuel Combustion	3. Transport; Road Transportation	Gaseous Fuels	N2O	0.00	0.00	0.000000	1.000
1A3e	1. Energy	A. Fuel Combustion	3. Transport; Other Transportation (militar		0 CO2	NO	NO	0.000000	1.000
1A3e	1. Energy	A. Fuel Combustion	3. Transport; Other Transportation (militar		0 CH4	0.00	0.00	0.000000	1.000
1A3e	1. Energy	A. Fuel Combustion	3. Transport; Other Transportation (militar		0 N2O	0.00	0.00	0.000000	1.000
1A4a	1. Energy	A. Fuel Combustion	4. Other Sectors; Commercial/Institutional	Solid Fuels	CO2	NO	NO	0.000000	1.000
1A4a	1. Energy	A. Fuel Combustion	4. Other Sectors; Commercial/Institutional	Solid Fuels	CH4	0.00	0.00	0.000000	1.000
1A4a	1. Energy	A. Fuel Combustion	4. Other Sectors; Commercial/Institutional	Solid Fuels	N2O	0.00	0.00	0.000000	1.000
1A4c	1. Energy	A. Fuel Combustion	4. Other Sectors; Agriculture/Forestry	Gaseous Fuels	CO2	NO	NO	0.000000	1.000
1A4c	1. Energy	A. Fuel Combustion	4. Other Sectors; Agriculture/Forestry	Gaseous Fuels	CH4	0.00	0.00	0.000000	1.000
1A4c	1. Energy	A. Fuel Combustion	4. Other Sectors; Agriculture/Forestry	Gaseous Fuels	N2O	0.00	0.00	0.000000	1.000
1B2	1. Energy	B. Fugitive Emissions	12. Oil and Natural Gas		CO2	NA,NO	NA,NO	0.000000	1.000
1B2	1. Energy	B. Fugitive Emissions	12. Oil and Natural Gas		N2O	NA,NO	NA,NO	0.000000	1.000
2A	2. Industrial Proc	A. Mineral Products			CO2	NO	NO	0.000000	1.000
2A	2. Industrial Proc	A. Mineral Products			CH4	NO	NO	0.000000	1.000
2A	2. Industrial Proc	A. Mineral Products			N2O	NO	NO	0.000000	1.000
2B	2. Industrial Proc	B. Chemical Industry			CO2	NO	NO	0.000000	1.000
2B	2. Industrial Proc	B. Chemical Industry			CH4	NO	NO	0.000000	1.000
2B	2. Industrial Proc	B. Chemical Industry			N2O	NO	NO	0.000000	1.000
2C	2. Industrial Proc	C. Metal Production			CO2	NO	NO	0.000000	1.000
2C	2. Industrial Proc	C. Metal Production			CH4	NO	NO	0.000000	1.000
2C	2. Industrial Proc	C. Metal Production			N2O	NO	NO	0.000000	1.000
2D	2. Industrial Proc	D. Other Production			CO2	NO	NO	0.000000	1.000
2E	2. Industrial Proc	E. Production of Halocarbons and SF6			CO2	0.00	0.00	0.000000	1.000
2F	2. Industrial Proc	F. Consumption of Halocarbons and SF6			PFC	NO	0.07	0.000000	1.000
2F	2. Industrial Proc	F. Consumption of Halocarbons and SF6			SF6	NO	0.01	0.000000	1.000
2F	2. Industrial Proc	F. Consumption of Halocarbons and SF6			CO2	0.00	0.00	0.000000	1.000
2G	2. Industrial Proc	G. Other			CO2	NO	NO	0.000000	1.000
2G	2. Industrial Proc	G. Other			CH4	NO	NO	0.000000	1.000
2G	2. Industrial Proc	G. Other			N2O	NO	NO	0.000000	1.000
4C	4. Agriculture	C. Rice Cultivation			CH4	NA,NO	NA,NO	0.000000	1.000
4D	4. Agriculture	D. Agricultural Soils			CH4	NA,NO	NA,NO	0.000000	1.000
4E	4. Agriculture	E. Prescribed Burning of Savannas			CH4	NA	NA	0.000000	1.000
4E	4. Agriculture	E. Prescribed Burning of Savannas			N2O	NA	NA	0.000000	1.000
4F	4. Agriculture	F. Field Burning of Agricultural Residues			CH4	NA,NO	NA,NO	0.000000	1.000
4F	4. Agriculture	F. Field Burning of Agricultural Residues			N2O	NA,NO	NA,NO	0.000000	1.000
4G	4. Agriculture	G. Other			CH4	NA	NA	0.000000	1.000
4G	4. Agriculture	G. Other			N2O	NA	NA	0.000000	1.000
5A1	5. LULUCF	A. Forest Land	1. Forest Land remaining Forest Land		CH4	0.00	0.00	0.000000	1.000
5A1	5. LULUCF	A. Forest Land	1. Forest Land remaining Forest Land		N2O	0.00	0.00	0.000000	1.000
5D1	5. LULUCF	D. Wetlands	1. Wetlands remaining Wetlands		CO2	0.00	0.00	0.000000	1.000
6A	6. Waste	A. Solid Waste Disposal on Land			CO2	NO	NO	0.000000	1.000
6D	6. Waste	D. Other			CO2	NO	NO	0.000000	1.000
TOTAL					<i>All</i>	260.85	254.93		

Table A - 4 Liechtenstein's key categories in 2011 including LULUCF categories (Summary). In accordance with GPG (IPCC 2000) estimates for removals are accounted with a positive sign.

IPCC Source Categories (and fuels if applicable) Source Category Analysis Summary					Direct GHG	Key Source Category Flag	If Column C is Yes, Criteria for Identification
1A3b	1. Energy	A. Fuel Combustion	3. Transport; Road Transportation	Gasoline	CO2	yes	Level, Trend
1A3b	1. Energy	A. Fuel Combustion	3. Transport; Road Transportation	Diesel	CO2	yes	Level, Trend
1A4a	1. Energy	A. Fuel Combustion	4. Other Sectors; Commercial/Institutional	Liquid Fuels	CO2	yes	Level, Trend
1A4b	1. Energy	A. Fuel Combustion	4. Other Sectors; Residential	Gaseous Fuels	CO2	yes	Level, Trend
1A4a	1. Energy	A. Fuel Combustion	4. Other Sectors; Commercial/Institutional	Gaseous Fuels	CO2	yes	Level, Trend
5A1	5. LULUCF	A. Forest Land	1. Forest Land remaining Forest Land		CO2	yes	Level, Trend
4A	4. Agriculture	A. Enteric Fermentatio			CH4	yes	Level
1A2	1. Energy	A. Fuel Combustion	2. Manufacturing Industries and Construct	Gaseous Fuels	CO2	yes	Level, Trend
1A4b	1. Energy	A. Fuel Combustion	4. Other Sectors; Residential	Liquid Fuels	CO2	yes	Level, Trend
1A2	1. Energy	A. Fuel Combustion	2. Manufacturing Industries and Construct	Liquid Fuels	CO2	yes	Level, Trend
2F	2. Industrial Proc.	F. Consumption of Hal			HFC	yes	Level, Trend
4D1	4. Agriculture	D. Agricultural Soils; D			N2O	yes	Level
5B1	5. LULUCF	B. Cropland	1. Cropland remaining Cropland		CO2	yes	Level
1A5	1. Energy	A. Fuel Combustion	5. Other	Liquid Fuels	CO2	yes	Level, Trend
5E2	5. LULUCF	E. Settlements	2. Land converted to Settlements		CO2	yes	Level
1A3b	1. Energy	A. Fuel Combustion	3. Transport; Road Transportation	Gaseous Fuels	CO2	yes	Level, Trend
1A1	1. Energy	A. Fuel Combustion	1. Energy Industries	Gaseous Fuels	CO2	yes	Level, Trend
4D3	4. Agriculture	D. Agricultural Soils; In			N2O	yes	Level
5C2	5. LULUCF	C. Grassland	2. Land converted to Grassland		CO2	yes	Level, Trend
4B	4. Agriculture	B. Manure Managemen			CH4	yes	Level
5A2	5. LULUCF	A. Forest Land	2. Land converted to Forest Land		CO2	yes	Level
4B	4. Agriculture	B. Manure Managemen			N2O	no	
5F2	5. LULUCF	F. Other Land	2. Land converted to Other Land		CO2	yes	Trend
5C1	5. LULUCF	C. Grassland	1. Grassland remaining Grassland		CO2	no	
4D_o	4. Agriculture	D. Agricultural Soils wi			N2O	no	
1A4c	1. Energy	A. Fuel Combustion	4. Other Sectors; Agriculture/Forestry	Liquid Fuels	CO2	no	
1B2	1. Energy	B. Fugitive Emissions	2. Oil and Natural Gas		CH4	no	
6B	6. Waste	B. Wastewater Handlir			N2O	no	
3	3. Solvent and Othe				CO2	no	
1A4b	1. Energy	A. Fuel Combustion	4. Other Sectors; Residential	Biomass	CH4	no	
6D	6. Waste	D. Other			CH4	no	
1A3b	1. Energy	A. Fuel Combustion	3. Transport; Road Transportation	Gasoline	N2O	no	
5E1	5. LULUCF	E. Settlements	1. Settlements remaining Settlements		CO2	no	
3	3. Solvent and Othe				N2O	no	
5B2	5. LULUCF	B. Cropland	2. Land converted to Cropland		CO2	no	
5D2	5. LULUCF	D. Wetlands	2. Land converted to Wetlands		CO2	no	
1A3a	1. Energy	A. Fuel Combustion	3. Transport; Civil Aviation		CO2	no	
6D	6. Waste	D. Other			N2O	no	
1A3b	1. Energy	A. Fuel Combustion	3. Transport; Road Transportation	Gasoline	CH4	no	
1A3b	1. Energy	A. Fuel Combustion	3. Transport; Road Transportation	Diesel	N2O	no	
1A4b	1. Energy	A. Fuel Combustion	4. Other Sectors; Residential	Gaseous Fuels	N2O	no	
1A1	1. Energy	A. Fuel Combustion	1. Energy Industries	Biomass	N2O	no	
2F	2. Industrial Proc.	F. Consumption of Hal			PFC	no	
1A4a	1. Energy	A. Fuel Combustion	4. Other Sectors; Commercial/Institutional	Liquid Fuels	N2O	no	
6B	6. Waste	B. Wastewater Handlir			CH4	no	
1A4a	1. Energy	A. Fuel Combustion	4. Other Sectors; Commercial/Institutional	Biomass	N2O	no	
1A3b	1. Energy	A. Fuel Combustion	3. Transport; Road Transportation	Biomass	CH4	no	
1A4b	1. Energy	A. Fuel Combustion	4. Other Sectors; Residential	Gaseous Fuels	CH4	no	
1A5	1. Energy	A. Fuel Combustion	5. Other	Liquid Fuels	N2O	no	
1A4a	1. Energy	A. Fuel Combustion	4. Other Sectors; Commercial/Institutional	Gaseous Fuels	CH4	no	
1A4b	1. Energy	A. Fuel Combustion	4. Other Sectors; Residential	Biomass	N2O	no	
6C	6. Waste	C. Waste Incineration			CO2	no	
1A1	1. Energy	A. Fuel Combustion	1. Energy Industries	Gaseous Fuels	CH4	no	
1A2	1. Energy	A. Fuel Combustion	2. Manufacturing Industries and Construct	Gaseous Fuels	CH4	no	
1A4b	1. Energy	A. Fuel Combustion	4. Other Sectors; Residential	Liquid Fuels	N2O	no	
1A2	1. Energy	A. Fuel Combustion	2. Manufacturing Industries and Construct	Liquid Fuels	N2O	no	
1A4a	1. Energy	A. Fuel Combustion	4. Other Sectors; Commercial/Institutional	Biomass	CH4	no	
5B2	5. LULUCF	B. Cropland	2. Land converted to Cropland		N2O	no	
2F	2. Industrial Proc.	F. Consumption of Hal			SF6	no	
6A	6. Waste	A. Solid Waste Dispos.			CH4	no	
1A4c	1. Energy	A. Fuel Combustion	4. Other Sectors; Agriculture/Forestry	Liquid Fuels	N2O	no	
1A4a	1. Energy	A. Fuel Combustion	4. Other Sectors; Commercial/Institutional	Gaseous Fuels	N2O	no	
1A4a	1. Energy	A. Fuel Combustion	4. Other Sectors; Commercial/Institutional	Liquid Fuels	CH4	no	
1A2	1. Energy	A. Fuel Combustion	2. Manufacturing Industries and Construct	Gaseous Fuels	N2O	no	
6C	6. Waste	C. Waste Incineration			CH4	no	
1A4b	1. Energy	A. Fuel Combustion	4. Other Sectors; Residential	Solid Fuels	CO2	no	
1A3b	1. Energy	A. Fuel Combustion	3. Transport; Road Transportation	Diesel	CH4	no	
1A1	1. Energy	A. Fuel Combustion	1. Energy Industries	Biomass	CH4	no	
1A4b	1. Energy	A. Fuel Combustion	4. Other Sectors; Residential	Liquid Fuels	CH4	no	
1A2	1. Energy	A. Fuel Combustion	2. Manufacturing Industries and Construct	Liquid Fuels	CH4	no	
1A3b	1. Energy	A. Fuel Combustion	3. Transport; Road Transportation	Biomass	N2O	no	
1A1	1. Energy	A. Fuel Combustion	1. Energy Industries	Gaseous Fuels	N2O	no	
1A3a	1. Energy	A. Fuel Combustion	3. Transport; Civil Aviation		N2O	no	
1A5	1. Energy	A. Fuel Combustion	5. Other	Liquid Fuels	CH4	no	
1A4b	1. Energy	A. Fuel Combustion	4. Other Sectors; Residential	Solid Fuels	CH4	no	
1A4c	1. Energy	A. Fuel Combustion	4. Other Sectors; Agriculture/Forestry	Liquid Fuels	CH4	no	
6C	6. Waste	C. Waste Incineration			N2O	no	
1A4b	1. Energy	A. Fuel Combustion	4. Other Sectors; Residential	Solid Fuels	N2O	no	
1A3a	1. Energy	A. Fuel Combustion	3. Transport; Civil Aviation		CH4	no	
1A1	1. Energy	A. Fuel Combustion	1. Energy Industries	Liquid Fuels	CO2	no	
1A1	1. Energy	A. Fuel Combustion	1. Energy Industries	Solid Fuels	CO2	no	

(Cont'd next page)

IPCC Source Categories (and fuels if applicable) Source Category Analysis Summary					Direct GHG	Key Source Category Flag	If Column C is Yes, Criteria for Identification
1A1	1. Energy	A. Fuel Combustion	1. Energy Industries	Other Fuels	CO2	no	
1A1	1. Energy	A. Fuel Combustion	1. Energy Industries	Liquid Fuels	CH4	no	
1A1	1. Energy	A. Fuel Combustion	1. Energy Industries	Solid Fuels	CH4	no	
1A1	1. Energy	A. Fuel Combustion	1. Energy Industries	Other Fuels	CH4	no	
1A1	1. Energy	A. Fuel Combustion	1. Energy Industries	Liquid Fuels	N2O	no	
1A1	1. Energy	A. Fuel Combustion	1. Energy Industries	Solid Fuels	N2O	no	
1A1	1. Energy	A. Fuel Combustion	1. Energy Industries	Other Fuels	N2O	no	
1A2	1. Energy	A. Fuel Combustion	2. Manufacturing Industries and Constructi	Solid Fuels	CO2	no	
1A2	1. Energy	A. Fuel Combustion	2. Manufacturing Industries and Constructi	Other Fuels	CO2	no	
1A2	1. Energy	A. Fuel Combustion	2. Manufacturing Industries and Constructi	Solid Fuels	CH4	no	
1A2	1. Energy	A. Fuel Combustion	2. Manufacturing Industries and Constructi	Biomass	CH4	no	
1A2	1. Energy	A. Fuel Combustion	2. Manufacturing Industries and Constructi	Other Fuels	CH4	no	
1A2	1. Energy	A. Fuel Combustion	2. Manufacturing Industries and Constructi	Solid Fuels	N2O	no	
1A2	1. Energy	A. Fuel Combustion	2. Manufacturing Industries and Constructi	Biomass	N2O	no	
1A2	1. Energy	A. Fuel Combustion	2. Manufacturing Industries and Constructi	Other Fuels	N2O	no	
1A3b	1. Energy	A. Fuel Combustion	3. Transport; Road Transportation	Gaseous Fuels	CH4	no	
1A3b	1. Energy	A. Fuel Combustion	3. Transport; Road Transportation	Gaseous Fuels	N2O	no	
1A3e	1. Energy	A. Fuel Combustion	3. Transport; Other Transportation (militar		CO2	no	
1A3e	1. Energy	A. Fuel Combustion	3. Transport; Other Transportation (militar		CH4	no	
1A3e	1. Energy	A. Fuel Combustion	3. Transport; Other Transportation (militar		N2O	no	
1A4a	1. Energy	A. Fuel Combustion	4. Other Sectors; Commercial/Institutional	Solid Fuels	CO2	no	
1A4a	1. Energy	A. Fuel Combustion	4. Other Sectors; Commercial/Institutional	Solid Fuels	CH4	no	
1A4a	1. Energy	A. Fuel Combustion	4. Other Sectors; Commercial/Institutional	Solid Fuels	N2O	no	
1A4c	1. Energy	A. Fuel Combustion	4. Other Sectors; Agriculture/Forestry	Gaseous Fuels	CO2	no	
1A4c	1. Energy	A. Fuel Combustion	4. Other Sectors; Agriculture/Forestry	Gaseous Fuels	CH4	no	
1A4c	1. Energy	A. Fuel Combustion	4. Other Sectors; Agriculture/Forestry	Gaseous Fuels	N2O	no	
1B2	1. Energy	B. Fugitive Emissions f2. Oil and Natural Gas			CO2	no	
1B2	1. Energy	B. Fugitive Emissions f2. Oil and Natural Gas			N2O	no	
2A	2. Industrial Proc.	A. Mineral Products			CO2	no	
2A	2. Industrial Proc.	A. Mineral Products			CH4	no	
2A	2. Industrial Proc.	A. Mineral Products			N2O	no	
2B	2. Industrial Proc.	B. Chemical Industry			CO2	no	
2B	2. Industrial Proc.	B. Chemical Industry			CH4	no	
2B	2. Industrial Proc.	B. Chemical Industry			N2O	no	
2C	2. Industrial Proc.	C. Metal Production			CO2	no	
2C	2. Industrial Proc.	C. Metal Production			CH4	no	
2C	2. Industrial Proc.	C. Metal Production			N2O	no	
2D	2. Industrial Proc.	D. Other Production			CO2	no	
2E	2. Industrial Proc.	E. Production of Halocarbons and SF6			CO2	no	
2F	2. Industrial Proc.	F. Consumption of Halocarbons and SF6			CO2	no	
2G	2. Industrial Proc.	G. Other			CO2	no	
2G	2. Industrial Proc.	G. Other			CH4	no	
2G	2. Industrial Proc.	G. Other			N2O	no	
4C	4. Agriculture	C. Rice Cultivation			CH4	no	
4D	4. Agriculture	D. Agricultural Soils			CH4	no	
4E	4. Agriculture	E. Prescribed Burning of Savannas			CH4	no	
4E	4. Agriculture	E. Prescribed Burning of Savannas			N2O	no	
4F	4. Agriculture	F. Field Burning of Agricultural Residues			CH4	no	
4F	4. Agriculture	F. Field Burning of Agricultural Residues			N2O	no	
4G	4. Agriculture	G. Other			CH4	no	
4G	4. Agriculture	G. Other			N2O	no	
5A1	5. LULUCF	A. Forest Land	1. Forest Land remaining Forest Land		CH4	no	
5A1	5. LULUCF	A. Forest Land	1. Forest Land remaining Forest Land		N2O	no	
5D1	5. LULUCF	D. Wetlands	1. Wetlands remaining Wetlands		CO2	no	
6A	6. Waste	A. Solid Waste Disposal on Land			CO2	no	
6D	6. Waste	D. Other			CO2	no	

Annex 2: Detailed discussion of methodology and data for estimating CO₂ emissions from fossil fuel combustion

No supplementary information.

Annex 3: Other detailed methodological descriptions for individual source or sink categories

A3.1 Additional Data for N₂O Emission Calculation of Agricultural Soils (4D)

Table A - 5 Additional data for N₂O emission calculation of agricultural soils (4D).

2011	Unit	Activity Data
1. Cereals		
Wheat	a	12'157
Barley	a	4'812
Maize	a	2'726
Oats	a	0
Rye	a	414
<i>Other (please specify)</i>		
Triticale	a	1'581
Spelt	a	777
Mix of fodder cereals	a	354
Mix of bread cereals		
2. Pulse		
Dry bean	a	0
peas (Eiweisserbsen)	a	0
Soybeans	a	150
<i>Other (please specify)</i>		
Leguminous vegetables	a	1'500
3. Tuber and Root		
Potatoes	a	6'646
<i>Other (please specify)</i>		
Fodder beet	a	839
Sugar beet	a	2'320
5. Other (please specify)		
Silage corn	a	39'812
Green corn	a	0
Fruit	a	348
Vine	t	145
Non-leguminous vegetables	a	8'673
Sunflowers	a	0
Tobacco	a	0
Rape	a	0
Total Non-leguminous	t	86'604
Total Leguminous	a	1'650
Total	a	88'254

Annex 4: CO₂ Reference Approach and comparison with Sectoral Approach, and relevant information on the national energy balance

No supplementary information to the statements given in Chapter 3.2.1 Comparison of Sectoral Approach with Reference Approach.

Annex 5: Assessment of completeness and (potential) sources and sinks of greenhouse gas emissions and removals excluded

No supplementary information to the statements given in Chapter 1.8 Completeness Assessment

Annex 6: Additional information to be considered as part of the NIR submission (where relevant) or other useful reference information

No supplementary information.

Annex 7: Supplementary Information to the Uncertainty Analysis Tier 2

A7.1 Monte Carlo simulations for Liechtenstein's GHG inventory

A Tier 2 uncertainty analysis for Liechtenstein's GHG Inventory was carried out for the inventory submitted in 2009 (OEP 2009a) and contained a level uncertainty for 2007 and a trend uncertainty for the period 1990-2007. The Monte Carlo simulation will be repeated in a subsequent year, but was neither carried out for 2008, 2009 nor for the current inventory year 2010. The results shown below may therefore not be compared with the Tier 1 uncertainty results for 2010 given in the Section 1.7.1.3.

The principle of Monte Carlo analysis is to select random values for emission factor and activity data from within their individual probability distributions, and to calculate the corresponding emission values. This procedure is repeated until an adequately stable result has been found. The results of all iterations yield the overall emission probability distribution.

In the analysis carried out for the GHG inventory 2007, Monte Carlo simulations were performed to estimate uncertainties both in emissions and in emission trends, at the source category level as well as for the inventory as a whole (excluding LULUCF). The simulations were run with the commercial software package Crystal Ball (® Decisioneering). This tool generates random numbers within user-defined probability ranges and probability distributions. As a result, selected statistics are produced for the forecast variables.

A7.2 Monte Carlo results for the GHG inventory 2007

a) Uncertainty in emissions

As a first step, for key categories, the shape and extent of the probability distributions were derived for the activity data and emission factors, based on measured data, literature or expert judgement. The mean value of the probability distributions was set equal to the value of the GHG inventory. In most cases, normal distributions were assumed. However, for two key categories with a high level of uncertainty (4D1 agricultural soils, direct emissions N₂O and 4D3 agricultural soils, indirect emissions N₂O), normal distribution would allow negative emissions. For these cases, log-normal distributions were used. The log-normal distribution is positively skewed and produces only positive values, while the upper bound of emissions may be poorly known.

As a second step, emissions were calculated as emission factor multiplied by the corresponding activity data. For those cases where the activity data or emission factor for a specific source category were not available as well as for all non key categories, emissions were modelled directly, with the mean value set equal to the value of the GHG inventory and an adequate probability distribution of the emissions.

The Monte Carlo simulation then provided information on the simulated distribution, on the 2.5 and 97.5 percentiles of emissions, on the uncertainty of the national total emission in 2007 and in the base year 1990 as well as on the trend uncertainty 1990–2007.

b) Dependent Uncertainties

Correlations may have a significant effect on the overall inventory uncertainty. The more the source categories are differentiated the more correlations become important. For the Liechtenstein inventory, the differentiation is on a relatively low level: The most important energy sector is only split into fuel types for the purpose of Monte Carlo simulation but not into source categories. Therefore only correlations between the fuel types have to be

considered for the level uncertainty, especially correlations between gasoline and diesel consumption. A detailed description of the assumptions for the present analysis and the respective correlation coefficients can be found in Annex A7. For consistency reasons, Crystal Ball software adjusted a few of the correlation coefficients by an average of 0.10.

c) Uncertainty in Emission Trends

The trend is defined as the difference between the base year and the year of interest (year t, 2007). Hence for estimation of the uncertainty in the emission trends, the Monte Carlo simulation was run for the year 2007 and for the base year 1990. The trend was then derived for the source categories as well as for the total emissions. It was assumed that

- the uncertainties for the base year are equal to the uncertainties of 2007 and that the probability distributions of the 1990 data are of equal shape as the distributions derived for 2007,
- the activity data of 1990 are positively correlated with the activity data of 2007 (correlation coefficients are set to 0.5)
- and that the emission factors of the two years are assumed to be positively correlated with correlation coefficient set to 1.0.

For a more sophisticated analysis, the uncertainties of the base year will have to be considered more closely and set larger for a couple of activity data. This improvement will have to be realised for a later submission.

d) Results

Uncertainties of national total 2007 and of trend 1990–2007

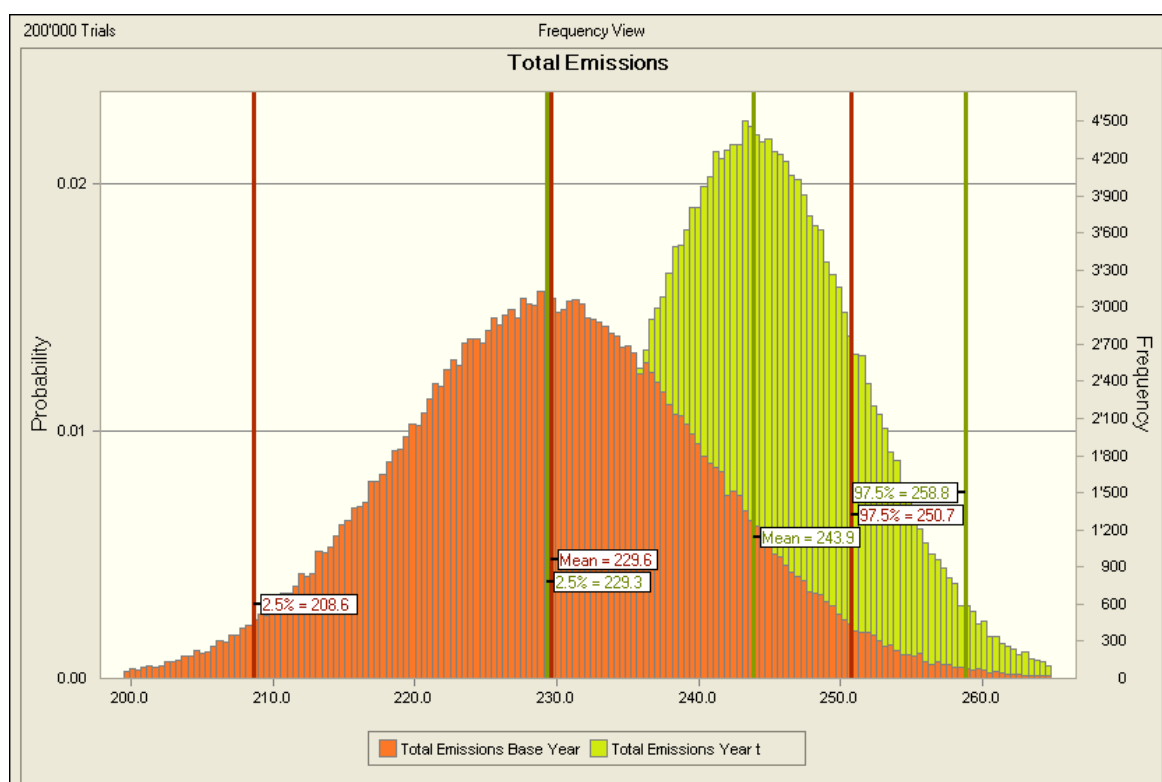

Figure A-1 Probability distributions of total emissions for the base year 1990 (in red) and year t=2007 (in green). On the x-axis, the total emissions reported in the inventory (excl. LULUCF) are given in Gg CO₂ eq. The number of Monte Carlo runs is 200'000. The vertical lines show simulated mean values (*Mean*) and the 2.5% and 97.5% percentile values.

Main results of the Monte Carlo simulation

Level uncertainty of national total emissions in 2007

The total uncertainty of the 2007 Liechtenstein emissions is **6,05%** (14.7 Gg CO₂ equivalent) of the total GHG emissions (243.5 Gg CO₂ equivalent excluding LULUCF).

The 95% confidence interval is almost symmetric and lies between **94.0% and 106.1%** of the Liechtenstein total GHG emissions. The end points are: 229.0 Gg (=243.5 Gg–14.5 Gg) and 258.4 Gg (=243.5 Gg+15.0 Gg).

Trend uncertainty of national total emissions 1990–2007

The change in total emissions between 1990 and 2007 is +6.1%. With a probability of 95%, the change lies within the range **of -2.7% to +15.0%, corresponding to a trend uncertainty of 8.9%**.

The uncertainty analysis presented in this paragraph is based on the data of the GHG inventory for 1990 and 2007 as previously submitted in March 2009. The Monte Carlo Simulation includes all emission source categories, i.e. key categories **and** non-key categories. However, both groups were treated slightly differently for the simulation:

Key categories: For the category 1A Energy Fuel Combustion, the uncertainties of both activity data and emission factors are taken into account for the simulation. For the remaining key categories, only the uncertainty of the emissions is taken into consideration.

Table A - 8: Tier 2 uncertainty results for sources in Liechtenstein 2007 (IPCC 2000, Table 6.2). In this table, uncertainties of the key categories are reported. For the non-key categories, see Table A - 10.

A IPCC Source Category	B Gas	C Base year (1990) emissions (Gg CO2 equivalent)	D Year t (2006) emissions (Gg CO2 equivalent)	E Uncertainty in year t emissions in the category		F Uncertainty in year t emissions as % of total in year t	G Uncertainty introduced on national total in year t (%)	H % change in emissions between year t and base year (%)	I Range of likely % change between year t and base year		J
				% below (2.5 percentile)	% above (97.5 percentile)				% below (2.5 percentile)	% above (97.5 percentile)	
1. CO2 emissions from Fuel Combustion											
1A	1. Energy	27.8	76.9	93	107	2.1	177	163	191		
	A. Fuel Combustion										
1A	1. Energy	94.6	45.6	80	120	3.7	-52	-69	-35		
	A. Fuel Combustion										
1A	1. Energy	60.5	55.8	90	110	2.3	-8	-17	2		
	A. Fuel Combustion										
1A	1. Energy	18.4	31.9	85	115	1.9	73	51	95		
	A. Fuel Combustion										
1A	1. Energy	0.08	0.13	85	115	0.0	77	55	100		
	A. Fuel Combustion										
1A	1. Energy	0.09	0.01	80	120	0.0	-86	-105	-68		
	A. Fuel Combustion										
2. Emissions which are not CO2 emissions from Fuel Combustion											
2F	2. Industrial Procl	0.00	4.5	86	114	0.2	53'245'125	46'017'556	60'445'379		
	F. Consumption of Halocarbons and SF6										
4A	4. Agriculture	9.8	10.4	82	118	0.8	6	-20	32		
	A. Enteric Fermentation										
4D1	4. Agriculture	5.8	5.7	25	175	1.7	-2	-110	107		
	D. Agricultural Soils: Direct Soil Emissions										
4D3	4. Agriculture	2.7	2.5	100	256	1.3	-8	-234	207		
	D. Agricultural Soils; Indirect Emissions										
Other		9.7	10.0	*	*	*	*	*	*		
Total		229.6	243.5	94.0	106.1	6.05	6.01	-2.7	15.0		

Table A-12 shows uncertainty results in a symmetrised form for the of the key categories. The uncertainty of the emission is only a Monte-Carlo simulated result for 1A source categories. For the other categories, the uncertainty of the emission is an input data for the Monte Carlo simulation.

Table A - 9 Activity data 2007, emission factors 2007, emissions 2007 and their corresponding uncertainties of key categories in Monte Carlo simulation see Table A -13

IPCC Source category	Gas	Activity Data Year t (2007)	Uncertainty of Activity Data (%)	Emission Factor	Uncertainty of Emission Factor (%)	Emissions Year t (Gg CO ₂ equivalent)	Uncertainty of Emissions (%)
1. CO2 emissions from Fuel Combustion							
1A 1. Energy	Gaseous fuels	1399 (TJ)	5.0	55.0 (t/TJ)	4.6	77	6.8
1A 1. Energy	Gas oil and LPG	619 (TJ)	20.0	73.6 (t/TJ)	0.6	46	20.0
1A 1. Energy	Gasoline	756 (TJ)	10.0	73.9 (t/TJ)	1.4	56	10.1
1A 1. Energy	Diesel	434 (TJ)	15.0	73.6 (t/TJ)	0.5	32	15.0
1A 1. Energy	Jet Kerosene	1.8 (TJ)	15.0	73.2 (t/TJ)	1.2	0.1	15.0
1A 1. Energy	Solid fuels	0.13 (TJ)	20.0	94.0 (t/TJ)	5.0	0.01	20.6
2. Emissions which are not CO2 emissions from Fuel Combustion							
2F	F. Consumption of Halocarbons and SF6					4.47	6.9
4A	A. Enteric Fermentation					10.38	9.2
4D1	D. Agricultural Soils; Direct Soil Emissions					5.66	38.3
4D3	D. Agricultural Soils; Indirect Emissions					2.51	79.6

Table A - 10 shows the results of the Tier 2 uncertainty calculation for all emission source categories, including non-key categories. The lower and the upper limit of the 95% confidence interval is given for each category, as well as the uncertainty introduced on the national total in year t (2007).

Table A - 10 Tier 2 Uncertainty calculation and reporting for all sources, including non-key categories.

A	B	C	D	E	F	G			
IPCC Source category	Gas	Base Year Emissions (1990)	Year t Emissions (2007)	Uncertainty in Year t emissions as % of emissions in the category (2.5 percentile)	Uncertainty in Year t emissions as % of emissions in the category (97.5 percentile)	Uncertainty introduced on national total in Year t (%)			
KEY SOURCES									
1. CO2 emissions from Fuel Combustion									
1A	1. Energy	A. Fuel Combustion	Gasoseous fuels	CO2	27.8	76.9	82.1	2.1	
1A	1. Energy	A. Fuel Combustion	Gas oil and LPG	CO2	94.6	45.6	36.6	54.5	3.7
1A	1. Energy	A. Fuel Combustion	Gasoline	CO2	50.3	55.8	61.4	36.6	2.3
1A	1. Energy	A. Fuel Combustion	Diesel	CO2	18.4	31.9	27.2	18.4	1.9
1A	1. Energy	A. Fuel Combustion	Jet Kerosene	CO2	0.08	0.13	0.1	0.2	0.01
1A	1. Energy	A. Fuel Combustion	Solid fuels	CO2	0.09	0.01	0.0	0.0	0.001
2. Emissions which are not CO2 emissions from Fuel Combustion									
2F	2. Industrial Proc.	F. Consumption of Halocarbons and SF6	HFC	0.00	4.5	3.9	5.1	0.2	
4A	4. Agriculture	A. Enteric Fermentation	CH4	10.4	8.5	12.2	9.9	0.8	
4D1	4. Agriculture	D. Agricultural Soils: Direct Soil Emissions	N2O	5.8	5.7	1.4	3.9	1.7	
4D3	4. Agriculture	D. Agricultural Soils: Indirect Emissions	N2O	2.7	2.5	0.0	6.4	1.3	
NON KEY SOURCES									
2F	2. Industrial Proc.	F. Consumption of Halocarbons and SF6	SF6	NO	0.12	0.1	0.1	0.0	
3	3. Solvent and Other Product Use	C. Waste Incineration	CO2	1.5	0.86	0.2	1.5	0.3	
6C	6. Waste	A. Fuel Combustion	CO2	0.01	0.01	0.0	0.0	0.0	
1A1	1. Energy	1. Energy Industries	Gasoseous Fuels	CH4	0.001	0.02	0.0	0.0	
1A1	1. Energy	A. Fuel Combustion	Biomass	CH4	0.002	0.00	0.0	0.0	
1A2	1. Energy	2. Manufacturing Industries and Constructio	Gasoseous Fuels	CH4	0.04	0.05	0.0	0.0	
1A2	1. Energy	A. Fuel Combustion	Liquid Fuels	CH4	0.01	0.00	0.0	0.0	
1A3a	1. Energy	3. Transport: Civil Aviation	Diesel	CH4	0.00	0.00	0.0	0.0	
1A3b	1. Energy	A. Fuel Combustion	Gasoline	CH4	0.01	0.0	0.0	0.0	
1A3b	1. Energy	3. Transport: Road Transportation	Gasoline	CH4	0.10	0.10	0.2	0.0	
1A3b	1. Energy	A. Fuel Combustion	Gasoseous Fuels	CH4	0.05	0.0	0.1	0.0	
1A3b	1. Energy	3. Transport: Road Transportation	Biomass	CH4	0.00	0.00	0.0	0.0	
1A4a	1. Energy	4. Other Sectors: Commercial/Institutional	Gasoseous Fuels	CH4	0.02	0.06	0.1	0.0	
1A4a	1. Energy	A. Fuel Combustion	Liquid Fuels	CH4	0.01	0.0	0.0	0.0	
1A4a	1. Energy	4. Other Sectors: Commercial/Institutional	Biomass	CH4	0.00	0.01	0.0	0.0	
1A4b	1. Energy	4. Other Sectors: Residential	Gasoseous Fuels	CH4	0.01	0.05	0.1	0.0	
1A4b	1. Energy	A. Fuel Combustion	Liquid Fuels	CH4	0.00	0.00	0.0	0.0	
1A4b	1. Energy	4. Other Sectors: Residential	Solid Fuels	CH4	0.01	0.00	0.0	0.0	
1A4b	1. Energy	4. Other Sectors: Residential	Biomass	CH4	0.13	0.42	0.3	0.1	
1A4c	1. Energy	4. Other Sectors: Agriculture/Forestry	Liquid Fuels	CH4	0.00	0.00	0.0	0.0	
1A5	1. Energy	A. Fuel Combustion	Liquid Fuels	CH4	0.00	0.00	0.0	0.0	
1B2	1. Energy	B. Fugitive Emissions from Fuels	Oil and Natural Gas	CH4	0.32	1.07	1.6	0.2	

(cont'd next page)

d) Comparison of Tier 1 with Tier 2 results

In the GHG inventory, some of the uncertainties may become large and their statistical distribution may clearly deviate from normal distributions. Tier 1 uncertainty analysis is based on simple error propagation, which assumes only small and normally distributed uncertainties. The application of the Tier 1 method is therefore not the optimal instrument for determining the uncertainties of a GHG inventory. The more appropriate choice is the Monte Carlo simulation, which is designed for uncertainties of any shape, for any size of uncertainties, any correlated figures and which is recommended by the IPCC Good Practice Guidance (IPCC 2000) as the Tier 2 method. The results of the Monte Carlo simulation are therefore considered to provide a more realistic picture of the uncertainties than the results of the Tier 1 method.

Tier 2 uncertainty analysis produces an overall level uncertainty of 6.05% for 2007 emissions. This value is somewhat larger than the result of Tier 1 uncertainty analysis for 2007 (5.95%). The correct treating of large uncertainties, the existence of correlations and the lognormal distributions for agricultural sources do all together increase the uncertainty slightly.

The trend uncertainty of Tier 2 analysis is 8.9% and is therefore somewhat larger than in Tier 1 analysis, 7.7% (both values hold for 2007). Although the positive correlations for activity data and emission factors between of the base year and the year 2007 tend to lower the trend uncertainty (as may be seen from equation A1.8 of IPCC Good Practice Guidance IPCC 2000 with $r > 0$), Tier 2 trend uncertainty is nevertheless larger than Tier 1 trend uncertainty. This may be explained by the methodological differences between Tier 1 and Tier 2 uncertainty analysis. Due to IPCC (2000), chapter 6.3, Tier 1 analysis uses Type A and Type B sensitivity to calculate the trend uncertainty, whereas Tier 2 simulates simple differences between the base year and year t but accounting for correlations between activity data and emission factors.

A7.3 Further assumptions for Monte Carlo simulation (GHG inventory 2007)

c) Relation between simulated and inventory values

The Monte Carlo simulation simulates a probability distribution for which all relevant statistical parameters are determined like mean, standard deviation and percentiles. The simulated mean value may slightly differ from the reported CRF value. This occurs because lognormal distributions are applied to some categories.

The discrepancy between simulated and reported values becomes apparent when mean numbers in Figure A-1 are compared to mean numbers in the CRF tables. Note that it is not a relevant issue for the uncertainty analysis but is rather confusing for readers and reviewers who carefully study the numbers. For transparency reasons, the numbers are explained in Table A - 11.

The absolute percentiles generated by the simulation are expressed as relative numbers (the simulated mean is set to 100%). The relative numbers are then transferred – unchanged – to the mean numbers as reported in the CRF tables, and they are applied to derive the absolute uncertainties (see).

Table A - 11 Mean values, 2.5% and 97.5% percentiles of the Monte Carlo simulation and corresponding values of the CRF emissions.

Parameters	Unit	Emission (excl. LULUCF)	Lower bound 2.5 percentile	Upper bound 97.5 percentile	Lower uncertainty	Upper uncertainty
simulated values		1990				
absolute	Gg CO ₂ eq	229.6	208.6	250.7	-21.0	21.2
relative	%	100.0%	90.9%	109.2%	-9.1%	9.2%
values of CRF						
absolute	Gg CO ₂ eq	229.6	208.6	250.7	-21.0	21.2
relative	%	100.0%	90.9%	109.2%	-9.1%	9.2%
simulated values		2007				
absolute	Gg CO ₂ eq	243.9	229.3	258.8	-14.5	15.0
relative	%	100.0%	94.0%	106.1%	-6.0%	6.1%
values of CRF						
absolute	Gg CO ₂ eq	243.5	229.0	258.4	-14.5	15.0
relative	%	100.0%	94.0%	106.1%	-6.0%	6.1%

a) Assumptions for probability distribution

Table A - 12 Probability distribution assigned to activity data, emission factors and emissions (1990 and 2007) of key categories. For the remaining categories, normal probability distributions have been assigned to the emission uncertainties.

IPCC Source Category		Fuel	Gas	Probability distribution		
				AD	EF	Emission
1. CO2 emissions from Fuel Combustion						
1A	1. Energy	Gaseous fuels	CO2	normal	normal	---
1A	1. Energy	Gas oil and LPG	CO2	normal	normal	---
1A	1. Energy	Gasoline	CO2	normal	normal	---
1A	1. Energy	Diesel	CO2	normal	normal	---
1A	1. Energy	Jet Kerosene	CO2	normal	normal	---
1A	1. Energy	Solid fuels	CO2	normal	normal	---
2. Emissions which are not CO2 emissions from Fuel Combustion						
2F	F. Consumption of Halocarbons and SF6		HFC	---	---	normal
4A	A. Enteric Fermentation		CH4	---	---	normal
4D1	D. Agricultural Soils; Direct Soil Emissions		N2O	---	---	lognormal
4D3	D. Agricultural Soils; Indirect Emissions		N2O	---	---	lognormal

b) Assumptions for correlations between activity data and emissions factors

For modelling of the **level uncertainty**, the following assumption has been made:

- the activity data of categories "1A Fuel combustion, gasoline" and "1A Fuel combustion, diesel" are positively correlated ($r = 0.3$). As gasoline and diesel sales are always accounted together (questionary filled by sellers), accounting uncertainty is expected to affect both fuels in the same way: either both are underestimated or both are overestimated (positive correlation).

For modelling of the **trend uncertainty**, the following assumptions have been made:

- the emission factors of each source are strongly and positively correlated ($r = 1.0$) between 1990 and 2007.
- also, the activity data of each source is positively correlated between 1990 and 2007 ($r = 0.5$). The correlation is not too strong since the methods for documenting the amounts of fuels sold have been changed at last for gasoline and diesel.

Annex 8: Supplementary Information the QA/QC System

A8.1 Checklists for QC activities

- Checklist for project manager (PM), project manager assistant (PMA), staff member climate unit (SC), sectoral experts (SE)
- Checklist for national inventory compiler (NIC)
- Checklist for NIR authors (NA)

Table A - 13 Checklist for QC activities and for follow-up activities if necessary (table depicted on next page). The general activities are taken from IPCC GPG, table 8.1, the country specific activities are ad-hoc activities of Good Practice Guidance (IPCC 2000). Abbr.: NA NIR authors, NIC national inventory compiler, PM project manager, PMA project manager assistant, DFP designated focal point, SC staff member climate unit, SE sectoral experts. Member codes: AG Andreas Gstoehl, HE Hanspeter Eberle, HK Helmut Kindle, JB Jürgen Beckbissinger, JH Juerg Heldstab, SK Stefan Kessler, MBE Mario Betschart, MH Martin Herren, BN Benedikt Notter, PI Patrick Insinna, DEF Denise Fussen, CHS Christine Seyler, Sven Braden,.

Liechtenstein Submission April 2013				
Checklist for sectoral experts and NIR Authors				
Contact person:		Jürg Heldstab (INFRAS)		
Telephone, e-mail:		+41 44 205 95 11, juerg.heldstab@infras.ch		
QC activity	Procedure (description of checks that were carried out)	responsibles	date	visa
General activities (table 8.1 IPCC GPG)				
General procedures				
1. Check that assumptions and criteria for the selection of activity data and emission factors are documented	Acontec-internal checks, comparison with methods chosen	SE/NIC	Sept - Dez 2012	JB
	EBP-internal checks, comparison with methods chosen	NA	06.01.13	DEF/CHS
	INFRAS-internal checks, comparison with methods chosen	NA	20.02.13	MH
2. Check for transcription errors in data input and reference	plausibility check of the basic input data for Solvent and Ind calculation	SE	16.10.12	JB
	plausibility check of the basic input data from the LWA	SE	22.11.12	JB
	check input Data for SF6 Emission calculation	SE	30.10.12	JB
	check stationary Energy	NA	18.12.12	DEF
	check Ind. Proc., Solvents	NA	21.12.12	CHS
	check Waste	NA	21.12.12	CHS
	Agriculture: Plausibility check of data in background tables Acontec. Several issues were identified and discussed with Acontec, improvements in documentation was discussed	SE	Dec 2013	BRI/JH
3. Check that emissions are calculated correctly	Ongoing checks of the calculated emissions in all sectors	SE	Oct - Dec	SE
	Clarification of data/figures with JB and MH	PM	Jan-Feb 2013	PI
	EBP-internal control: Plausibility checks, "Delta-Analysis" combined with KCA, INFRAS-internal control of time series, comparison with February 09 submission.	NA	18.12.12	DEF
	INFRAS-internal checks during generation of tables/figure in Chapter. 2 Trends (independent control by second person Juerg Heldstab)	SE	03.01.13	MH
4. Check that parameter and emission units are correctly recorded and that appropriate conversion factors are used	check energy-activity-data (reference approach)	SE	05.11.12	JB
	check input data in the sector Ind. and Solvent	SE	31.10.12	JB
	check Energy	SE	03.01.13	MH
	check Waste	SE	02.11.12	JB
	check Agriculture	SE	15.01.13	BN
	check LULUCF	SE	21.12.12	BRI
	check stationary Energy	NA	18.12.12	DEF
	check Ind. Proc., Solvents	NA	21.12.12	CHS
	check Waste	NA	21.12.12	CHS
	check mobile Energy	SE	14.01.12	MH
	check Agriculture	SE	06.01.12	JH

Continued on next page

5. Check the integrity of database files	integrity checked	SE	Nov. 2012	JB
6. Check for consistency in data between source categories	consistency checked		Sept - Nov 2012	JB
	check stationary Energy	NA	18.12.12	DEF
	check Ind. Proc., Solvents	NA	21.12.12	CHS
	check Waste	NA	21.12.12	CHS
	check mobile Energy	SE	14.01.12	MH
	check Agriculture	SE	06.01.12	JH
7. Check that the movement of inventory data among processing steps is correct	check LULUCF	SE	21.12.12	BRI
	Processing checked	NIC	Okt - Nov 2012	JB
	Data transfer from the land-use statistics to the LULUCF tables and clarification of comprehensive questions with JB / FL	SE	07.11.12	HE
	check Agriculture	SE	17.01.13	JH
	plausibility check / control of overall emissions from agriculture in CO2 equivalents, in total and for the source categories for all years	SE	18.01.13	JH
8. Check that uncertainties in emissions and removals are estimated or calculated correctly	check LULUCF	SE	21.12.12	BRI
	check stationary Energy	NA	18.12.12	DEF
	check Ind. Proc., Solvents	NA	21.12.12	CHS
	check stationary Waste	NA	21.12.12	CHS
	check mobile Energy, Agriculture	SE	13.12.12	MBE
9. Undertake review of internal documentation	check the correctness of data extrapolation in the LULUCF sector, based on the available land use inventories and the LFI	SE	21.12.12	BRI
	internal documentation checked	SE	07.01.13	JB
	Internal OEP check of documentation; Clarification of open questions with SE	PM/PMA	20.11.12	PI
	proofread energy section	NA	21.12.12	CHS
	proofread Ind. Proc., Solvents section	NA	20.12.12	DEF
	proofread waste section	NA	20.12.12	DEF
10. Check methodological and data changes resulting in recalculations	proofread NIR	NA	March	JH
	okay	SE	09.11.12	JB
11. Undertake completeness checks	Completeness check for Waste	SE	26.10.12	JB
	Completeness check for Energy		15.11.12	JB
12. Compare estimates to previous estimates	check of KCA previous/latest key categories	SE	12.12.12	MBE
	plausibility checks of the CRF tables	SE	15.11.12	MBE
	plausibility checks of the CRF tables	PM	07.12.12	PI
	check stationary Energy	NA	18.12.12	DEF
	check Ind. Proc., Solvents	NA	21.12.12	CHS
	check Waste	NA	21.12.12	CHS
	check mobile Energy, Agriculture,	SE	15.11.12	/MBE
	check Ind. Proc./Synthetic gases	SE	15.11.12	MH/SK
	check Agriculture	SE	15.11.12	BN
	check LULUCF	SE	21.12.12	BRI
13. Archiving activities	Internal Review of documents submitted in April 2012; All relevant documents archived	PM/PMA	05.01.13	PI
14. Further activities	see Inventory Development Plan, minutes of meetings Inventory Core Group and Review Reports UNFCCC	SE, NA, PM,PMA	Jun 2012/Mar 2013	all

Continued on next page

Country-specific activities	Specific procedures				
20. Where LIE uses Swiss-specific methods: If a change in the Swiss inventory occurs, check whether the change has to be adopted for LIE or not	clarification of comprehensive questions	PM/PMA	07.12.12	AG	
	check: Energy (stationary)	NA	18.12.12	DEF	
	check: Solvents	NA	21.12.12	CHS	
	Clarification of comprehensive questions in different sectors with SE	PM/NA	18.02.13	PI	
	two independent checks of Energy (mobile)	SE	03.01.12	MH, JH	
	check Energy (mobile)	SE	12.12.12	MBE	
	check waste	NA	21.12.12	CHS	
	check Agriculture	SE	Nov/Dec	BN	
	check LULUCF	SE	21.12.12	BRI	
	verification that land-use changes between different categories of unmanaged do not account for the UNFCCC inventory	SE	23.12.12	BRI	
	21. Where LIE uses Swiss-specific EF: Where changes in the Swiss EF occur, check whether the changes are also adequate for LIE or not	Clarify the changes of Emission factors in Agriculture	SE	17.10.12	JB
Clarify the changes of Emission factors in Solvent and other product use		SE	05.10.12	JB	
Clarify the changes of Emission factors and activity data in Industrial Processes		SE	02.10.12	JB	
check: Energy (stationary)		NA	18.12.12	DEF	
check: Solvents		NA	21.12.12	CHS	
check waste		NA	21.12.12	CHS	
check Energy (mobile)		SE	12.12.12	MBE	
check Agriculture		SE	15.12.12	BN	
check LULUCF		SE	21.12.12	BRI	
Plausibility checks of KCA		PM	16.11.12	PI	
22. Check correctness of KCA, comparison with previous results		cross-check within KCA with/without LULUCF 1990 and 2011: Emissions correct, thresholds correct. Comparison with KCA of Submission Apr 2012	NA	12.12.12	MBE
	EBP-internal plausibility checks	NA	18.12.12	DEF	
23. Check correctness of uncertainty analysis, comparison with previous results	Acontec internal plausibility checks	SE	Dec 2012	JB	
	INFRAS internal plausibility checks	NA	Dec 2012	MBE/BN/MH	
24. Check of transcription errors CRF -> NIR (numbers, tables, figures)	EBP-internal control: Comparison of data in CRF tables with NIR	NA	20.12.12	DEF/CHS	
	INFRAS-internal control: Comparison of data in CRF tables and NIR. For the transcription of emission data into chapters Exec. Summ., 2. Trends, X.1 Overview (in all sectors), Energy, Agriculture, a INFRAS collaborator generates figures and tables, copies them into NIR and adjusts the text correspondingly. These working steps are afterwards checked by another collaborator of INFRAS.	NA NIC	Dec 2012	MBE/JH/MH	
	EBP-internal checks	NA	20.12.12	DEF, CHS	
25. Check for complete and correct references in NIR	INFRAS-internal checks	NA	20.03.13	MBE	
	clarification of comprehensive questions	SE	Jan. 2013	JB	
26. Check for correctness, completeness, transparency and quality of NIR	final proofread Executive Summary, feedback to PI	NFP	March 2013	HK	
	final proofread inventory/NIR, feedback and discussion with PI	QM	March 2013	AG	
	final proofread inventory/NIR, discussion with JH, FL and JB	PM	March 2013	PI	
	final proofread inventory/NIR, feedback to PI	PMA	March 2013	SB	
	final proofread inventory/NIR, feedback to PI	SC	March 2013	HE	
	Internal OEP discussions on the inventory/NIR draft with AG, SB, HE and PI	PM/PMA	March 2013	PI	
	Feedback from OEP internal discussions	PM/PMA	March 2013	PI	
	Final proofreading inventory/NIR	PM/PMA	March 2013	PI	
	unification of terms in the LULUCF chapter, i.e. the altitude categories or the term combination (combined) categories CC	SE	21.12.12	BRI	
	27. Check for completeness of submission documents	Final check and Submission	PM/NIC NFP	15.04.13	HK/PI
		Archiving: INFRAS, EBP, save internally all data individually. NIR in MS-DOC and PDF format are sent to OEP. All tables in MS-EXCEL format are sent to OEP for separate archiving. Compile all emails related to report and data.	NA	01.04.13	JH, FL DEF, CHS
28. Further activities	Archiving: Save an backup all internally Data	NIC	01.04.14	JB	

A8.2 Checklists for QA activities (internal review)

Liechtenstein's National Inventory Report Review-Formular für das Interne Review Submission März 2013

Reviewer	Patrick Insinna
Amt / Firma	Office for the Environment
Telefon, E-Mail	4232366416
Begutachtete(s) Kapitel inklusive Annex, References	Alle Kapitel und Annexes

NIR-AutorIn	Jürg Heldstab
Firma	INFRAS
Telefon, E-mail	+41 44 205 95 11, juerg.heldstab@infrass.ch

Kommentare des Reviewers (gelb) und Erwiderung der Autorin/des Autors (grün)
<p>Startseite/Deckblatt : Im Rahmen der Re-Organisation der Liechtensteinischen Landesverwaltung, wurden das ehemalige Amt für Umweltschutz, das landwirtschaftsamt sowie das Amt für Wald,Natur und Landschaft in ein neues Amt für Umwelt überführt. Bitte im Kapitel 1.3.1. Die neue Situation kurz beschreiben und im gesamten Dokument Amt für Umweltschutz (OEP) durch Amt für Umwelt (OE) ersetzen. Zukünftig ebenfalls Literaturhinweise die von neuen Amt kommen entsprechend kennzeichnen.</p>
Done
<p>Startseite/Deckblatt: Bitte Heike Summer als Project manager Assistant mit in die Liste der Mitarbeiter des Amtes für Umwelt mit aufnehmen</p>
Done
<p>Kap 2-10: Einzelne redaktionelle Anmerkungen direkt im Text vermerkt; Bitte prüfen und umsetzen</p>
Done

Review zur Kenntnis genommen	
Datum / Signum	MH, 20.03.2013

Liechtenstein's National Inventory Report Review-Formular für das Interne Review Submission März 2013

Reviewer	Andreas Gstöhl
Amt / Firma	Amt für Umwelt /Abteilung Umweltschutz
Telefon, E-Mail	423 236 61 86, andreas.gstoehl@llv.li
Begutachtete(s) Kapitel inklusive Annex, References	ES, 1-2

NIR-AutorIn	Jürg Heldstab
Firma	INFRAS
Telefon, E-mail	+41 44 205 95 11, juerg.heldstab@infrass.ch

Kommentare des Reviewers (gelb) und Erwiderung der Autorin/des Autors (grün)	
Impressum, S. 3: Homepage Adresse anpassen auf www.aus.llv.li. Generelle Bemerkung: Neue Amtsbezeichnung OE berücksichtigen, betrifft bisherige Amtsstellen OEP, OA, OFNLM.	
Done	
ES. 4: Bezieht sich das Territorialprinzip nicht auf das Kyotoprotokoll anstatt das Genfer Übereinkommen? Bitte prüfen.	
Done	
part 1.1.1, page 25: veraltetes Energiekonzept 2013 (OEA, 2003) löschen und durch neue Energiestrategie 2020 (OEA, 2012) ersetzen.	
Done	
Verschiedene Fragen/Anmerkungen auf S. 13 (Permafrost), 21 (Jahrestemperaturen), 23 (Adaptation), 44 (Ostluft, Quellenaktualisierung).	
Done	
A8.3 IDP: verschiedene Bemerkungen/Fragen betreffend Zuständigkeiten und Status (siehe masterfile).	
Done	
Review durchgeführt	
Datum / Signum	06.02.2013, Andreas Gstöhl
Review zur Kenntnis genommen	
Datum / Signum	MH, 20.03.2013

Reviewer	Heike Summer
Amt / Firma	Amt für Umwelt /Abteilung Umweltschutz
Telefon, E-Mail	4232366196, heike.summer@llv.li
Begutachtete(s) Kapitel	ES, 1-2
inklusive Annex, References	

NIR-AutorIn	Jürg Heldstab
Firma	INFRAS
Telefon, E-mail	+41 44 205 95 11, juerg.heldstab@infrass.ch

Kommentare des Reviewers (gelb) und Erwiderung der Autorin/des Autors (grün)

Änderungen OEP in neues Amtskürzel (auch in den Abbildungen). Änderungen im Text wurden eingefügt, Fragen mittels Kommentarfeld eingefügt.

Done

Review durchgeführt	
Datum / Signum	17.1.2013 /Suhe

Review zur Kenntnis genommen	
Datum / Signum	MH, 20.03.2013

Reviewer	Sven Braden
Amt / Firma	Amt für Umwelt /Abteilung Umweltschutz/Fachbereich Klima
Telefon, E-Mail	423 236 7451, sven.braden@llv.li
Begutachtete(s) Kapitel	ES, Kap 1
inklusive Annex, References	

NIR-AutorIn	Jürg Heldstab
Firma	INFRAS
Telefon, E-mail	+41 44 205 95 11, juerg.heldstab@infrass.ch

Kommentare des Reviewers (gelb) und Erwiderung der Autorin/des Autors (grün)

ggfs. Zusammenlegung der Ämter (AWNL, AUS und Landwirtschaftsamt seit 1.1.2013; wohl nicht zwingend da Inventar 2011)

Done

Review durchgeführt	
Datum / Signum	17.02.2013, Sven Braden

Review zur Kenntnis genommen	
Datum / Signum	20.03.2013, MH

**Liechtenstein's National Inventory Report
Review-Formular für das Interne Review Submission März 2013**

Reviewer	Hanspeter Eberle
Amt / Firma	Amt für Umwelt
Telefon, E-Mail	00423 2366193
Begutachtete(s) Kapitel inklusive Annex, References	Kapitel 7

NIR-AutorIn	Jürg Heldstab
Firma	INFRAS
Telefon, E-mail	+41 44 205 95 11, juerg.heldstab@infrass.ch

Kommentare des Reviewers (gelb) und Erwiderung der Autorin/des Autors (grün)	

Review durchgeführt	
Datum / Signum	08.01.2013
Review zur Kenntnis genommen	
Datum / Signum	MH, 20.03.2013

Table A - 14 Checklists for QA activity internal review.

A8.3 IDP Inventory development plan

The Inventory Development Plan (IDP) is a tool within Liechtenstein's National Inventory System (NIS) to improve the Greenhouse Gas Inventory and the National Inventory Report (NIR). It is updated regularly based on the recommendations of the expert review teams of the UNFCCC (ERT). The last recommendations are FCCC/ARR/2006/LIE, FCCC/ARR/2008/LIE, FCCC/ARR/2009/LIE, FCCC/ARR/2010/LIE and FCCC/ARR/2011/LIE resulting from the Centralized Reviews in 2007, 2009, 2010 and 2011. The most recent recommendations from September 2012 are already partly addressed.

In the IDP the recommendations and planned improvements are summarized in a table. The meaning of the headers are shown on this page.

Responsibilities

Initial	Name	Institution
HK	Helmut Kindle	Office for the Environment (OE)
AG	Andreas Gstoehl	Office for the Environment (OE)
PI	Patrick Insinna	Office for the Environment (OE)
HSU	Heike Summer	Office for the Environment (OE)
HE	Hanspeter Eberle	Office for the Environment (OE)
SB	Sven Braden	Office for the Environment (OE)
JB	Jürgen Beckbissinger	Acontec, Schaan
DEF	Denise Fussen	Ernst Basler + Partner
CHS	Christina Seyler	Ernst Basler + Partner
JH	Jürg Heldstab	INFRAS
MH	Martin Herren	INFRAS
MBE	Mario Betschart	INFRAS
BN	Benedikt Notter	INFRAS

Status

Abbr.	Meaning
Finished	Work finished
Progress	Work in progress
Not to do	Work not yet started

Reference

The last column in the IDP "Reference" refers to the relevant paragraph in the report of the individual review of the greenhouse gas inventory of Liechtenstein of the corresponding year (e.g. 2011_64 translates into paragraph 64 of the report on the inventory submitted in 2011, FCCC/ARR/2011/LIE).

Cross-cutting issues / Miscellaneous

No	Planned improvement	Status	Reference
1	Completeness: CRF tables are completely filled with notation keys where appropriate. However, Liechtenstein did not complete table 7 for the years 1990–2003 and table 8 (b) for 1990–2005	progress	2008_10
2	The transparency of Liechtenstein's submission could be improved further by the inclusion of additional information, especially for the categories to which Swiss country-specific methodologies and/or EFs have been applied.	progress	2008_11
3	The IPCC good practice guidance provides a tier 2 uncertainty analysis based on a key category analysis. The ERT noted that Liechtenstein's uncertainty for both activity data (AD) and EFs are given only at an aggregated level, which does not facilitate a tier 2 key category analysis.	Not to do for Submission 2013	2008_16
4	Follow-up to previous reviews However, the ERT feels that the recommendation of the previous review to improve transparency in the energy and LULUCF sectors has not yet been fully addressed, and therefore the ERT reiterate the previous recommendation	progress	2008_19

Sector Energy

No	Planned improvement	Status	Reference
5	The ERT recommends that Liechtenstein reports the emissions from machinery in construction and industry under other (manufacturing industries and construction (1.2.Af) in its next annual inventory submission	Not to do for Submission 2013	2009_44
13	The ERT noted that Liechtenstein did not include the use of lubricants and bitumen in the inventory. What is the schedule for Liechtenstein to provide estimates on the consumption of both lubricants and bitumen in its inventory?	progress	Answers ERT questions sept. 2012

Sectors Industrial processes and solvent and other product use

No	Planned improvement	Status	Reference
	no planned improvement		

Sector Agriculture

No	Planned improvement	Status	Reference
19	Provide consistent cattle numbers and explain any differences with FAO statistics.	progress	ARR 2011_57
20	Provide additional information on the applicability of Swiss AWMS data to LIE inventory; Liechtenstein to report all required data in the NIR and CRF table 4.B(a).	progress	ARR 2011_58
21	Report AD of synthetic fertilizer use, compost and sewage sludge application separately and improve transparency on how data are obtained.	progress	ARR 2011_59
22	Report correct FracGASF and FracGASM figures in CRF table 4D (supposedly zero values were reported).	progress	ARR 2011_60

Sector LULUCF

No	Planned improvement	Status	Reference
23	The ERT recommends that Liechtenstein provide further information of its recalculation on the LULUCF sector in its next annual submission.	progress	2011_63
24	The ERT commends Liechtenstein for improving the transparency of its reporting of land-use areas by providing detailed information, including the latest land-use statistics for 2008.	progress	2011_64

Sector KP-LULUCF

No	Planned improvement	Status	Reference
30	The ERT recommends that Liechtenstein improve the transparency of its reporting of the KP-LULUCF supplementary information.	progress	2011_84
31	The ERT strongly recommends that Liechtenstein provide transparent and complete land-related information in the NIR.	progress	2011_85
33	The ERT recommends that Liechtenstein improve the transparency and completeness of its reporting regarding recalculations.	progress	2011_87
35	The ERT recommends that, in its next annual submission, Liechtenstein provide country-specific verifiable information or assessment in its next NIR, describing the specific condition of these pools and their management practices and how they affect carbon content.	progress	2011_90
36	The ERT strongly recommends that Liechtenstein provide more transparent and complete documentation of the methods or models and assumptions used for the carbon stock changes of deforestation.	progress	2011_91

Sector Waste

No	Planned improvement	Status	Reference
	no planned improvement		

Done for Submission 2013

Cross-cutting Issues/Miscellaneous

No	Planned improvement	Status	Reference
	no planned improvement		

Sector Energy

No	Planned improvement	Status	Reference
6	The ERT strongly recommends that Liechtenstein estimate CH ₄ fugitive emissions for public electricity, heat production and commercial/institutional and residential categories.	Finished in Submission 2013	2011_41
7	The ERT strongly recommends that Liechtenstein justify in its next NIR that the fugitive emissions of natural gas transmission do not occur or, if they are included elsewhere, that the Party use the correct notation key (fE). If these emissions are not estimated, the ERT strongly recommends that Liechtenstein estimate these emissions in its next annual submission.	Finished in Submission 2013	2011_42
8	The ERT strongly recommends more detailed explanations about the gas oil shares of Liechtenstein.	Finished in Submission 2013	Answers ERT questions sept. 2012
9	Related to the NIR page 75, Table 3-19 Activity for natural gas and biomass consumption in 1A1 public electricity/heat production, can Liechtenstein explain the rapid increase of natural gas consumption between 1990, 1991, and 1992?	Finished in Submission 2013	Answers ERT questions sept. 2012
10	Could Liechtenstein explain why they don't use the default oxidation factor for CO ₂ in the energy chapter?	Finished in Submission 2013	Answers ERT questions sept. 2012
11	Can Liechtenstein provide more explanation on the activity data for fuel consumption in 1A2F Manufacturing industries and construction between 1990 and 2010?	Finished in Submission 2013	Answers ERT questions sept. 2012
12	Can Liechtenstein provide more explanation to confirm that the coal properties between the Liechtenstein and Switzerland are similar?	Finished in Submission 2013	Answers ERT questions sept. 2012
14	The ERT considers that the waste incineration plant is situated in Switzerland and therefore the district heating is provided from Switzerland. It is recommended to include a description of this in the next annual submission.	Finished in Submission 2013	Answers ERT questions sept. 2012

Sectors Industrial processes and solvent and other product use

No	Planned improvement	Status	Reference
15	Provide additional information on differences between the IPCC methodologies and CS methodology used for estimating emissions from 2F1 Refrigeration and Air Conditioning Equipment.	Finished in Submission 2013	2011_43
16	Report on the reasons why HFC emissions in the period 2004 - 2006 changed the previous trend.	Finished in Submission 2013	2011_46
17	Additional information on how Switzerland estimates PFC emissions.	Finished in Submission 2013	2011_47
18	Provide detailed explanation on declining trend of SF ₆ emissions from the Sub category 2F8 Electrical Equipment from 2008 - 2010.	Finished in Submission 2013	2011_03

Done for Submission 2013 (cont.)**Sector Agriculture**

No	Planned improvement	Status	Reference
	no planned improvement		

Sector LULUCF

No	Planned improvement	Status	Reference
25	The ERT strongly reiterates the recommendation that Liechtenstein use the 20-year default IPCC value for reporting land-use conversion or provide sufficient justification for the use of a 12-year conversion in its next annual submission.	Finished in Submission 2013	2011_65
26	The ERT recommends that Liechtenstein estimates the emissions from biomass burning or, if it is not applicable for some years, explain why and use the correct notation key (NO) for biomass burning in its next annual submission.	Finished in Submission 2013	2011_66
27	Liechtenstein has reported the area of organic soils as "NE" for all years of the inventory time series. Further, the carbon stock changes from organic soils are reported as included elsewhere" (IE) under mineral soils. The ERT recommends that Liechtenstein address this issue in its next annual submission.	Finished in Submission 2013	2011_68
28	The ERT recommends that Liechtenstein improve completeness of its reporting of the key category carbon stock changes from organic soils by replacing the notation keys by the appropriate values in its next annual submission.	Finished in Submission 2013	2011_70
29	The ERT encourages Liechtenstein to address that carbon stock changes from organic soils are reported as "IE" in its next annual submission or to provide background information and additional explanations.	Finished in Submission 2013	2011_74

Sector KP-LULUCF

No	Planned improvement	Status	Reference
32	The ERT strongly recommends that Liechtenstein complete the reporting of the biomass burning emissions.	Finished in Submission 2013	2011_86
34	The ERT recommends that Liechtenstein include additional information on below-ground biomass emissions.	Finished in Submission 2013	2011_89
37	The ERT strongly recommends that Liechtenstein, in its next annual submission, provide either separate estimates for above-ground and below-ground biomass or comprehensive additional information regarding the approach used and provide estimates for the carbon stock changes for organic soils.	Finished in Submission 2013	2011_92

Sector Waste

No	Planned improvement	Status	Reference
38	In previous submissions, the emission factor of fossil CO ₂ by waste incineration has been calculated by multiplying the corresponding Swiss EF by the factor 0.4. It will be verified whether this is plausible or should be corrected elsewhere. Furthermore it will be checked whether it is justified to use a different emission factor for N ₂ O than in the Swiss NIR.	Finished in Submission 2013	2008_80

Annex 9: Voluntary Supplementary Information for Article 3 paragraph 3 of the Kyoto Protocol: Kyoto Tables

No supplementary information in addition to Chapter 11

Annex 10: Information required under Art. 7 paragraph 2 of the Kyoto Protocol: National Registry and Commitment Period Reserve (CPR)

A10.1 Introduction

Under the terms of Art. 7 of the Kyoto Protocol, each Party included in Annex I shall provide the necessary supplementary information in its National Inventory Report (NIR) to demonstrate compliance with Art. 3 of the Kyoto Protocol. Decision 15/CMP.1 is – inter alia – focusing on the reporting requirements for changes in the national registries. Additionally decision 15/CMP.1 refer to Art. 5, para 1, defining the national Guidelines for national systems. Each Party shall describe the changes that have occurred in the system as well as in the registry, compared with the information reported in its last submission. The changes described are in comparison with the NIR submitted in April 2012.

A10.2 Changes in the National System

Changes in the National System have occurred since the last submission. The following mentioned Articles refer to the COMMISSION REGULATION (EU) No 920/2010.

The consolidation of European national registries (including all EU Member States, Iceland, Liechtenstein and Norway) was a significant change to the system of registries.

Liechtenstein joined the EU Member States, who are also Parties to the Kyoto Protocol (25) as well as Iceland and Norway, to operate their registries in a consolidated manner in accordance with all relevant decisions applicable to the establishment of Party registries - in particular Decision 13/CMP.1 and decision 24/CP.8.

A10.3 Registry administrator

The name and contact information of the registry administrator designated by the Party to maintain the national registry:

The changes compared to previous submission (2012) are listed below:

Registry Administrator

Office of the Environment

P.O. Box 684

Dr. Grass-Strasse 12

9490 Vaduz

Principality of Liechtenstein

phone: +423 236 75 96

fax: +423 236 64 11

email: registry@llv.li

website: http://www.llv.li/amtsstellen/llv-aus-emissionshandel_en.htm

Contacts

Main Contact

Heike Summer

Email: heike.summer@llv.li

Alternative Contact 1

Andreas Gstoehl

Email: andreas.gstoehl@llv.li

Alternative Contact 2

Helmut Kindle

Email: helmut.kindle@llv.li

A10.4 Consolidated system

The names of the other Parties with which the Party cooperates by maintaining the national registries in a consolidated system:

The consolidation of European national registries (including all EU Member States, Iceland, Liechtenstein and Norway) was a significant change to the system of registries. After certification of the consolidated System of EU registries on 1st June 2012, on 19 June 2012, 29 registries became operational under the Consolidated System of European Union Registries (CSEUR). A detailed description is given in the EU Commission Regulation 920/2010. The complete description of the consolidated registry was provided in the common readiness documentation and specific readiness documentation for the national registry of the EU and all consolidating national registries. This description includes:

- Readiness questionnaire
- Application logging
- Change management procedure
- Disaster recovery
- Manual Intervention
- Operational Plan
- Roles and responsibilities
- Security Plan
- Time Validation Plan
- Version change Management

The required documents are confidential and accessible for assessors only. Therefore the documents which are mentioned are not available within this document. The documents above will be submitted separately as an appendix to the final NIR 2013 on April 15 2013 and **MUST NOT** be published in any form.

A10.5 Database structure and capacity

Description of the database structure and capacity of the national registry:

For the purposes of meeting their obligations as KP Parties and under Article 6 of the European Union Decision No 280/2004/EC to ensure the accurate accounting of Kyoto units, each Member State and the Union operate a registry (hereinafter 'KP registry') in the form of a standardised electronic database that complies with the UNFCCC's requirements concerning registries, and in particular the functional and technical specifications for data exchange standards for registry systems under the Kyoto Protocol elaborated pursuant to Decision 12/CMP.1 of the Conference of the Parties serving as the meeting of the Parties to the Kyoto Protocol. The Union registry and every other KP registry conform to the functional and technical specifications for data exchange standards for registry systems under the Kyoto Protocol elaborated pursuant to Decision 12/CMP.1 and comply with the hardware, network and software and security requirements set out in the Data Exchange and Technical Specifications provided European Union Transaction Log (EUTL) is used as an independent transaction log that records and checks the issue, transfer and cancellations of allowances in

the form of a standardised electronic database. The EUTL also serves to record all information relating to the holdings and transfers of Kyoto units made available.

The standardised and secured system of registries in the form of standardised electronic databases containing common data elements to track the issue, holding, transfer and cancellation of allowances, to provide for public access and confidentiality as appropriate and to ensure that there are no transfers which are incompatible with the obligations resulting from the Kyoto Protocol is drawn up.

The required documents are confidential and accessible for assessors only. Therefore the descriptions are not available within this document. The documents will be submitted separately as an appendix to the final NIR 2013 on April 15 2013 and **MUST NOT** be published in any form.

A10.6 Conformity with Data Exchange Standards (DES)

Description of how the national registry conforms to the technical standards for data exchange between registry systems for the purpose of ensuring the accurate, transparent and efficient exchange of data between national registries, the clean development mechanism registry and the transaction log (decision 19/CP.7):

In order to ensure that Kyoto units and allowances can be held on the same Union registry accounts, the Union registry must also conform to the functional and technical specifications for data exchange standards for registry systems under the Kyoto Protocol, adopted by Decision 12/CMP.1,

The EUTL is capable of checking and recording all processes referred to under Article 3(2), and is conform to the functional and technical specifications for data exchange standards for registry systems under the Kyoto Protocol elaborated pursuant to Decision 12/CMP.1 and comply with the hardware, network and software requirements set out in the Data Exchange and Technical Specifications. The Union registry and every other KP registry are conform to the functional and technical specifications for data exchange standards for registry systems under the Kyoto Protocol elaborated pursuant to Decision 12/CMP.1 and comply with the hardware, network and software and security requirements set out in the Data Exchange and Technical Specifications.

The required documents are confidential and accessible for assessors only. Therefore the descriptions are not available within this document. The documents will be submitted separately as an appendix to the final NIR 2013 on April 15 2013 and **MUST NOT** be published in any form.

A10.7 Prevention of discrepancies

Description of the procedures employed in the national registry to minimize discrepancies in the issuance, transfer, acquisition, cancellation and retirement of ERUs, CERs, tCERs, ICERs, AAUs and/or RMUs, and replacement of tCERs and ICERs, and of the steps taken to terminate transactions where a discrepancy is notified and to correct problems in the event of a failure to terminate the transactions:

The Union registry and every other KP registry check input codes and check response codes to ensure the correct interpretation of information exchanged during each process. The check codes shall correspond to those contained in the Data Exchange and Technical Specifications. The consolidated system adopts the Data Exchange and Technical Specifications necessary for exchanging data between registries and transaction logs, including the identification codes, automated checks and response codes, as well as the

testing procedures and security requirements necessary for the launching of data exchange. The Data Exchange and Technical Specifications shall be consistent with the functional and technical specifications for data exchange standards for registry systems under the Kyoto Protocol elaborated pursuant to Decision 12/CMP.1. Prior to and during the execution of all processes the Union registry shall conduct appropriate automated checks to ensure that discrepancies are detected and incorrect processes are terminated in advance of automated checks being conducted by the EUTL. In case of processes completed through the direct communication link between the Union registry and the EUTL referred to in Article 5(2) of the previous mentioned regulation, the EUTL terminates any processes where it identifies discrepancies upon conducting the automated checks referred to in Article 66(2) of the mentioned regulation, and informs thereof the Union registry and the administrator of the accounts involved in the terminated transaction by returning an automated check response code. The Union registry immediately informs the relevant account holders that the process has been terminated.

In case of transactions completed through the ITL referred to in Article 5(1) of the mentioned regulation, the ITL terminates any processes where discrepancies are identified either by the ITL or the EUTL upon conducting the automated checks referred to in Article 66(2) of the mentioned regulation. Following a termination by the ITL, the EUTL also terminates the transaction. The ITL informs the administrators of the registries involved of the termination of the transaction by returning an automated check response code. If one of the registries involved is the Union registry, the Union registry also informs the administrator of the Union registry accounts involved in the terminated transaction by returning an automated check response code. The Union registry immediately informs the relevant account holders that the process has been terminated.

The required documents are confidential and accessible for assessors only. Therefore the descriptions are not available within this document. The documents will be submitted separately as an appendix to the final NIR 2013 on April 15 2013 and **MUST NOT** be published in any form.

A10.8 Determent of unauthorized manipulations

An overview of security measures employed in the national registry to prevent unauthorized manipulations and to prevent operator error and of how these measures are kept up to date:

The identity of the Union registry are authenticated towards the EUTL with digital certificates and usernames and passwords as indicated in the Data Exchange and Technical Specifications .

The Member States and the Union use the digital certificates issued by the Secretariat to the UNFCCC, or an entity designated by it, to authenticate their registries to the ITL for the purposes of establishing the communication. Adequate and harmonised requirements on authentication and access rights are applied to protect the security of information held in the integrated registries system and records concerning all processes, operators and persons in the registries system are kept.

Authentication of registries and the EUTL

1. The identity of the Union registry is authenticated towards the EUTL with digital certificates and usernames and passwords as indicated in the Data Exchange and Technical Specifications provided for in Article 71.

2. The Member States and the Union use the digital certificates issued by the Secretariat to the UNFCCC, or an entity designated by it, to authenticate their registries to the ITL for the purposes of establishing the communication link referred to in Article 5.

Accessing accounts in the Union registry

1. Account holders are able to access their accounts in the Union registry through the secure area of the Union registry. The Central administrator ensures that the secure area of the Union registry website is accessible through the Internet. The website of the Union registry is available in all languages of the European Union.
2. The Central administrator ensures that accounts in the Union registry where access through trading platforms in accordance with Article 19(3) is enabled and one authorised representative is also the authorised representative of a trading platform holding account are accessible to the trading platform operated by the holder of that trading platform holding account.
3. Communications between authorised representatives or trading platforms and the secure area of Union registry are encrypted in accordance with the security requirements set out in the Data Exchange and Technical Specifications provided for in Article 71.
4. The Central administrator takes all necessary steps to ensure that unauthorised access to the secure area of the Union registry website does not occur.
5. If the security of the credentials of an authorised representative or additional authorised representative has been compromised, the authorised representative or additional authorised representative shall immediately inform the administrator of the account thereof and request a replacement.

Authentication and authorisation of authorised representatives in the Union registry

1. The Union registry issues each authorised representative and additional authorised representative with a username and password to authenticate them for the purposes of accessing the registry.
2. An authorised representative or additional authorised representative only have access to the accounts within the Union registry which he is authorised to access and only be able to request the initiation of processes which he is authorised to request pursuant to Article 19. That access or request takes place through a secure area of the website of the Union registry.
3. In addition to the username and password referred to in paragraph 1, national administrators provides secondary authentication to all accounts administered by them. The types of secondary authentication mechanisms that can be used to access the Union registry shall be set out in the Data Exchange and Technical Specifications provided for in Article 71.
4. The administrator of an account may assume that a user who was successfully authenticated by the Union registry is the authorised representative or additional authorised representative registered under the provided authentication credentials, unless the authorised representative or additional authorised representative informs the administrator of the account that the security of his credentials has been compromised and requests a replacement. EN L 270/22 Official Journal of the European Union 14.10.2010.

Suspension of all access by authorised representatives due to a security breach

1. The Central Administrator may suspend access to the Union registry or the EUTL if there is a breach of security of the Union registry or the EUTL which threatens the integrity of the registries system, including the back-up facilities referred to in Article 59.
2. The administrator of a KP registry may suspend access by all users to its KP registry if there is a breach of security of the KP registry which threatens the integrity of the registries system, including the back-up facilities referred to in Article 59.

3. In the event of a breach of security that may lead to suspension of access, the administrator who becomes aware of the breach shall promptly inform the Central Administrator of any risks posed to other parts of the registries system. The Central Administrator shall then inform all other administrators.

4. If an administrator becomes aware of a situation that requires the suspension of all access to its system, it shall inform the Central Administrator and account holders with such prior notice of the suspension as is practicable. The Central Administrator will then inform all other administrators as soon as possible.

5. The notice referred to in paragraph 3 shall include the likely duration of the suspension and shall be clearly displayed on the public area of that KP registry's website or on the public area of the EUTL's website.

The required documents are confidential and accessible for assessors only. Therefore the descriptions are not available within this document. The documents will be submitted separately as an appendix to the final NIR 2013 on April 15 2013 and **MUST NOT** be published in any form.

In 2012 an additional security measure has been implemented. The third account representative has been set to mandatory as of February 2012. This representative fulfils the function to confirm transactions initiated by the first and second representative. This 4-eyes-principle should restrain the possibility of transactions done by unauthorized persons who have hacked or stolen access data from representatives.

A10.9 Public Reports

A list of the information publicly accessible by means of the user interface to the union registry:

Pursuant to paragraphs 44 to 48 in section I.E of the annex to decision 13/CMP.1, Liechtenstein makes non-confidential information available to public using Registry Homepage and/or user interface. In Liechtenstein the following information is considered as non-confidential and publicly accessible on website: <http://ec.europa.eu/environment/ets/> .

13/CMP.1 annex II paragraph 45	The requested information is publicly available for all accounts. The data of operator holding accounts can be viewed online at:
Account information	http://ec.europa.eu/environment/ets/account.do?languageCode=en&account.registryCodes=LI&account.accountFullTypeCodes=100-7&identifierInReg=&accountHolder=&search=Search&searchType=account&currentSortSettings=
	<p>The data of all accounts can be viewed online at:</p> <p>http://ec.europa.eu/environment/ets/account.do?languageCode=en&account.registryCodes=LI&identifierInReg=&accountHolder=&search=Search&searchType=account&currentSortSettings=</p>
	Representative name and contact information is classified as confidential due to Article 83 paragraph 8 and 9 Registry Regulation No. 1193/2011.
13/CMP.1 annex II	This information is available on the website:

<p>paragraph 46</p> <p>Joint implementation project information</p>	<p>http://www.llv.li/amtsstellen/llv-aus-emissionshandel_en/llv-aus-emissionshandelsregister_flexible_mechanismen_en/llv-aus-emissionshandel-genehmigte_projekte_en.htm</p>														
<p>13/CMP.1 annex II paragraph 47</p> <p>Unit holding and transaction information</p>	<p>The information requested in (a), (d), (f) and (l) is classified as confidential due to Article 83 paragraph 1 Registry Regulation No. 1193/2011 as well as national data protection law and therefore not publicly available. Transactions of units within the most recent five year period are also classified as confidential, therefore the transactions provided are only those completed more than five years in the past.</p> <p>The information requested in (b), (c), (e), (g), (h), (i), (j) and (k) is publicly available at</p> <p>(b) In 2012 there was no issuance of AAU.</p> <p>(c) In 2012 no ERUs were issued.</p> <p>(e) No RMU was issued in the reported year.</p> <p>(g) No RMU was cancelled on the basis of activities under Article 3, paragraph 3 and 4 in the reported year.</p> <p>(h) No ERU, CER, AAU and RMU were cancelled on the basis of activities under Article 3, paragraph 1 in the reported year.</p> <p>(i) In 2012, no AAU, no ERU and no CER were voluntary cancelled. No RMU was cancelled.</p> <p>(j) In 2012, no ERU, no CER, no AAU, and no RMU, tCER, ICER were retired.</p> <p>(k) There was no carry over of ERU, CER, AAU or RMU from the previous commitment period.</p>														
<p>13/CMP.1 annex II paragraph 48</p> <p>Authorized legal entities information</p>	<p>The following legal entities are authorized by the Member State to hold Kyoto units:</p> <table border="1" data-bbox="469 1498 1326 1998"> <thead> <tr> <th></th> <th>Legal entities authorised by Liechtenstein to hold units</th> </tr> </thead> <tbody> <tr> <td>AAU</td> <td>Federal Government, TA</td> </tr> <tr> <td>ERU</td> <td>Each account holder of OHA, PHA, TA and NHA</td> </tr> <tr> <td>CER</td> <td>Each account holder of OHA, PHA, TA and NHA</td> </tr> <tr> <td>RMU</td> <td>Federal Government only, TA</td> </tr> <tr> <td>tCER</td> <td>Federal Government only, TA</td> </tr> <tr> <td>ICER</td> <td>Federal Government only, TA</td> </tr> </tbody> </table>		Legal entities authorised by Liechtenstein to hold units	AAU	Federal Government, TA	ERU	Each account holder of OHA, PHA, TA and NHA	CER	Each account holder of OHA, PHA, TA and NHA	RMU	Federal Government only, TA	tCER	Federal Government only, TA	ICER	Federal Government only, TA
	Legal entities authorised by Liechtenstein to hold units														
AAU	Federal Government, TA														
ERU	Each account holder of OHA, PHA, TA and NHA														
CER	Each account holder of OHA, PHA, TA and NHA														
RMU	Federal Government only, TA														
tCER	Federal Government only, TA														
ICER	Federal Government only, TA														

OHA: Operator Holding Account (installation and aircraft)
PHA: Person Holding Account
TA: Trading Account
NHA: National Holding Account

A10.10 Internet address

No changes compared to submission 2012. The URL of the interface for the national registry of Liechtenstein is:

www.emissionshandelsregister.li and alias

www.emissionstradingregistry.li

A10.11 Safeguard and Recovery Plan

A description of measures taken to safeguard, maintain and recover data in order to ensure the integrity of data storage and the recovery of registry services in the event of a disaster.

The Central Administrator of the CSEUR shall ensure that the Union registry and EUTL incorporate robust systems and procedures for the safeguarding of all data and the prompt recovery of all data and operations in the event of a disaster as stated in the new requirements of Commission Regulation 920/2010.

The required documents are confidential and accessible for assessors only. Therefore the documents which are mentioned are not available within this document. The documents above will be submitted separately as an appendix to the final NIR 2013 on April 15 2013 and **MUST NOT** be published in any form.

A10.12 Test procedures

The results of any test procedures that might be available or developed with the aim of testing the performance, procedures and security measures of the national registry undertaken pursuant to the provisions of decision 19/CP.7 relating to the technical standards for data exchange between registry systems:

The accounting mechanisms are described in the COMMISSION REGULATION (EU) No 920/2010, Article 52. The described steps below refer to the commission regulation.

Minimum deposited quantity on the ETS AAU deposit account

1. The EUTL shall record a minimum deposited quantity for each Member State. In the case of Member States with KP registries, the EUTL will prevent transfers of Kyoto units from their ETS AAU deposit account that would result in Kyoto unit holdings on the ETS AAU deposit account that are below the minimum deposited quantity. In the case of Member States with no KP registry, the minimum deposited quantity is a value used in the clearing process.
2. The EUTL shall add a quantity to the minimum deposited quantity after an issue of Chapter III allowances has taken place in accordance with Article 39, where the addition shall be equal to the amount of Chapter III allowances issued.

3. The EUTL shall deduct a quantity from the minimum deposited quantity immediately after:
- (a) a transfer of Chapter III allowances to the Union allowance deletion account has taken place as a result of downwards correction of Chapter III allowances after their allocation in accordance with Article 37(3), where the deduction shall be equal to the amount of Chapter III allowances transferred;
 - (b) a set-aside of Kyoto units against surrenders of Chapter III allowances by aircraft operators in accordance with Article 54 has taken place, where the deduction shall be equal to the amount set-aside;
 - (c) a cancellation of Kyoto units against deletions of Chapter III allowances in accordance with Article 55(1) has taken place, where the deduction shall be equal to the quantity cancelled;
 - (d) a deletion of allowances set out in Article 55(2) took place, where the deduction shall be equal to the quantity deleted.
4. The Central Administrator carries out a deduction of a quantity from the minimum deposited quantity recorded in the EUTL after the clearing transactions in accordance with Article 56 have taken place. The deduction shall equal the total amount of Chapter III allowances surrendered by user accounts administered by the national administrator of the Member State for the 2008-12 period; plus the clearing value calculated in accordance with Article 56(3).

The required documents are confidential and accessible for assessors only. Therefore the documents which are mentioned are not available within this document. The documents above will be submitted separately as an appendix to the final NIR 2013 on April 15 2013 and **MUST NOT** be published in any form.

A10.13 Commitment period reserve (CPR)

The determination of the CPR is given in Chapter 12.5 of this NIR. There are no further explanations in this Annex.